

Image Reconstruction

Partial k-space Reconstruction

M229 Advanced Topics in MRI

Kyung Sung, Ph.D.

2021.05.06

Class Business

- Office hours
 - Instructors: Fri 10-12pm
email beforehand would be helpful

Today's Topics

- Fourier transform symmetries
 - Odd and Even functions
- Motivation for partial k-space recon
- Partial k-space recon methods
 - Direct method (Homodyne)
 - Iterative method (POCS)
- MATLAB code demo

Even and Odd Functions

- function f is even (or symmetric) when

$$f(x) = f(-x)$$

- function f is odd (or antisymmetric) when

$$f(x) = -f(-x)$$

Even and Odd Functions

- Any function can be written as a sum of even and odd functions

$$\begin{aligned} f(x) &= \frac{1}{2}[f(x) + f(-x) - f(-x) + f(x)] \\ &= \underbrace{\frac{1}{2}[f(x) + f(-x)]}_{f_e(x)} + \underbrace{\frac{1}{2}[f(x) - f(-x)]}_{f_o(x)} \end{aligned}$$

Even and Odd Functions

- The integral of the product of odd and even functions is zero

$$\begin{aligned} & \int_{-\infty}^{\infty} f_e(x) f_o(x) dx \\ &= \int_{-\infty}^0 f_e(x) f_o(x) dx + \int_0^{\infty} f_e(x) f_o(x) dx \\ &= \int_0^{\infty} [f_e(-x) f_o(-x) dx + f_e(x) f_o(x)] dx \end{aligned}$$

Fourier Transform Symmetry

$$F(f) = \int_{-\infty}^{\infty} f(x) e^{-j2\pi x f} dx$$

$$F(f) = \int_{-\infty}^{\infty} f(x) \cos(2\pi x f) dx - j \int_{-\infty}^{\infty} f(x) \sin(2\pi x f) dx$$

$$F(f) = \int_{-\infty}^{\infty} f_e(x) \cos(2\pi x f) dx + \int_{-\infty}^{\infty} f_o(x) \cos(2\pi x f) dx$$

$$-j \int_{-\infty}^{\infty} f_e(x) \sin(2\pi x f) dx - j \int_{-\infty}^{\infty} f_o(x) \sin(2\pi x f) dx$$

Fourier Transform Symmetry

$$F(f) = \int_{-\infty}^{\infty} f_e(x) \cos(2\pi x f) dx - j \int_{-\infty}^{\infty} f_o(x) \sin(2\pi x f) dx$$

$$F(f) = F_e(f) + F_o(f)$$

real & even function?

real & odd function?

even function?

odd function?

Fourier Transform Symmetry

- Fourier transform of even part (of a real function) is real

$$FT\{f_e(x)\} = Re\{F_e(f)\}$$

- Fourier transform of even part is even

$$FT\{f_e(x)\} = F_e(f) = F_e(-f)$$

Fourier Transform Symmetry

- Fourier transform of odd part (of a real function) is imaginary

$$FT\{f_o(x)\} = Im\{F_o(f)\}$$

- Fourier transform of odd part is odd

$$FT\{f_o(x)\} = F_o(f) = -F_o(-f)$$

Hermitian Symmetry

- We can summarize all four symmetries possessed by Fourier transform of a real function

To the board ...

Motivation

- MR images depict the spin density as a function of position
 - If this is true, only half of k-space data will need to be collected
 - Uncollected data could be synthesized by conjugate symmetry
- However, MR images are not real-valued!
 - Partial k-space reconstruction requires some type of phase correction

Magnitude

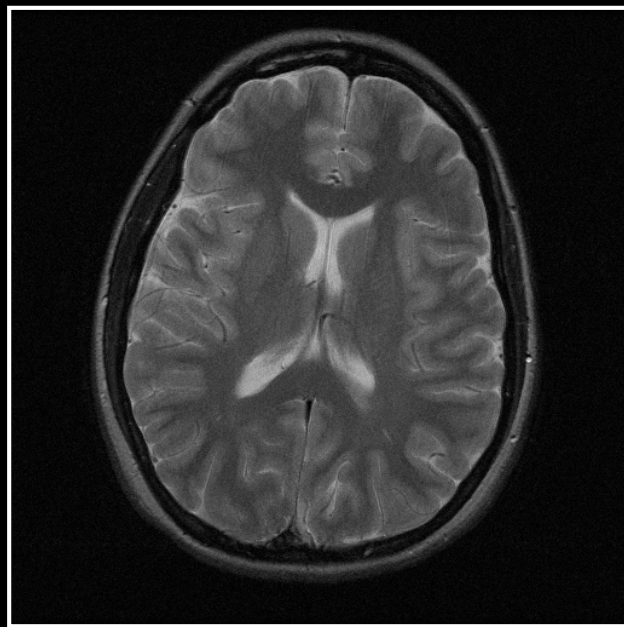

Phase

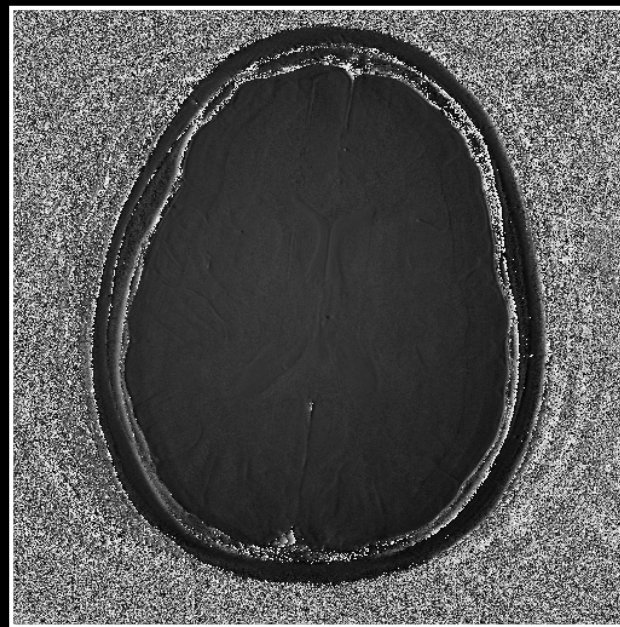

Real

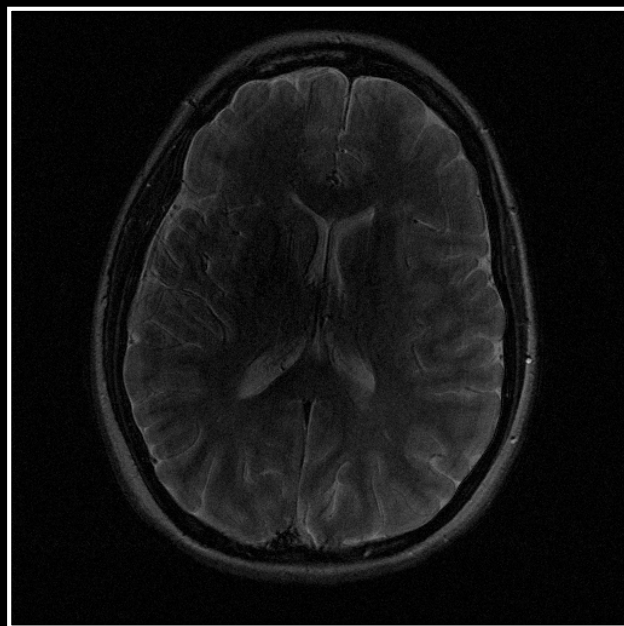

Imaginary

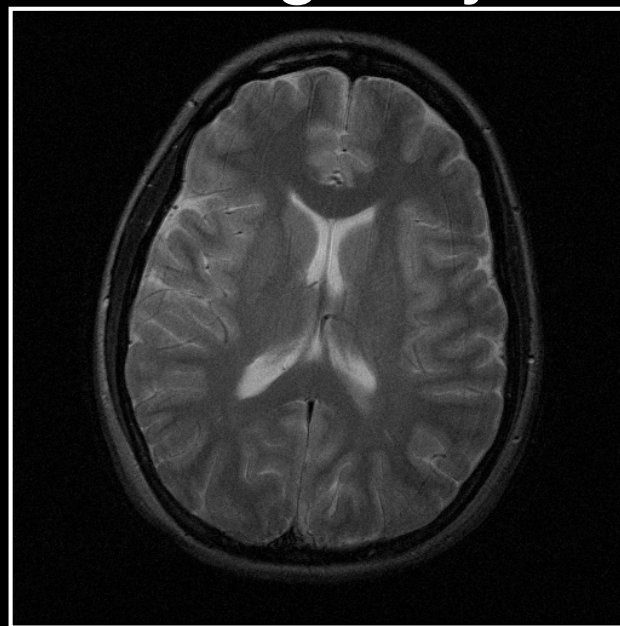

Cartesian 2D Imaging

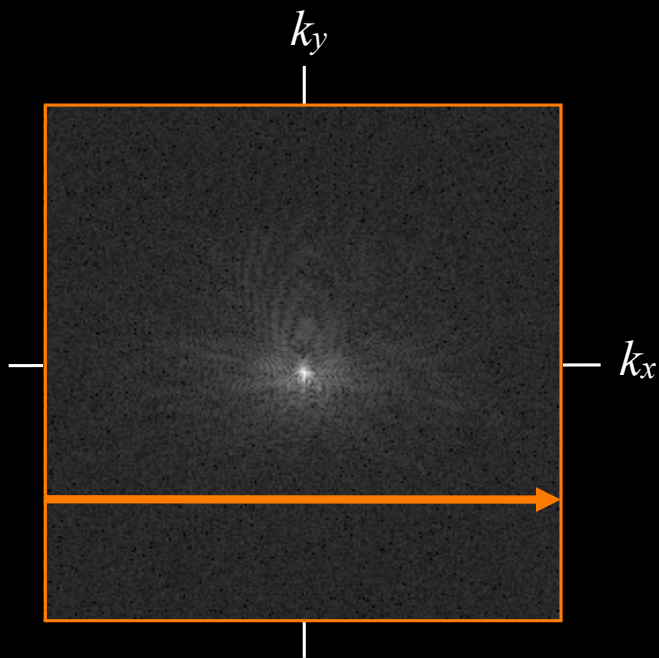

Pulse Sequence Diagram

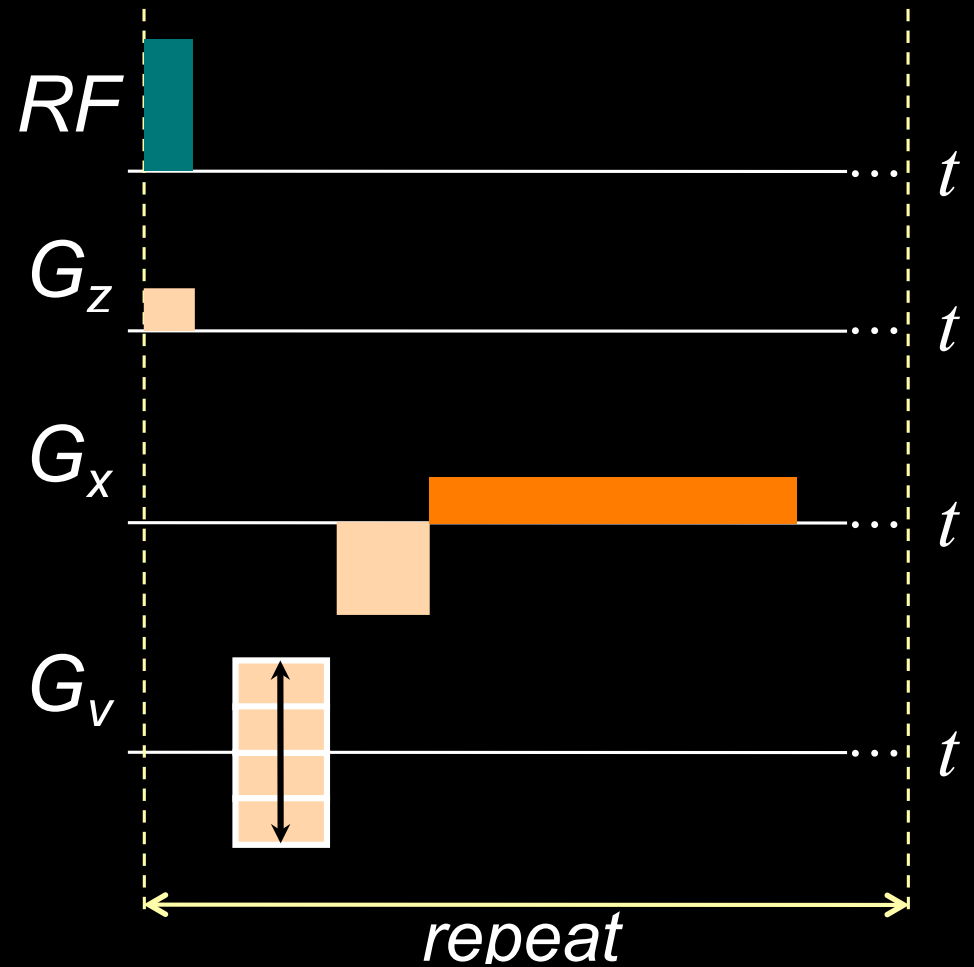

Cartesian Sampling Application

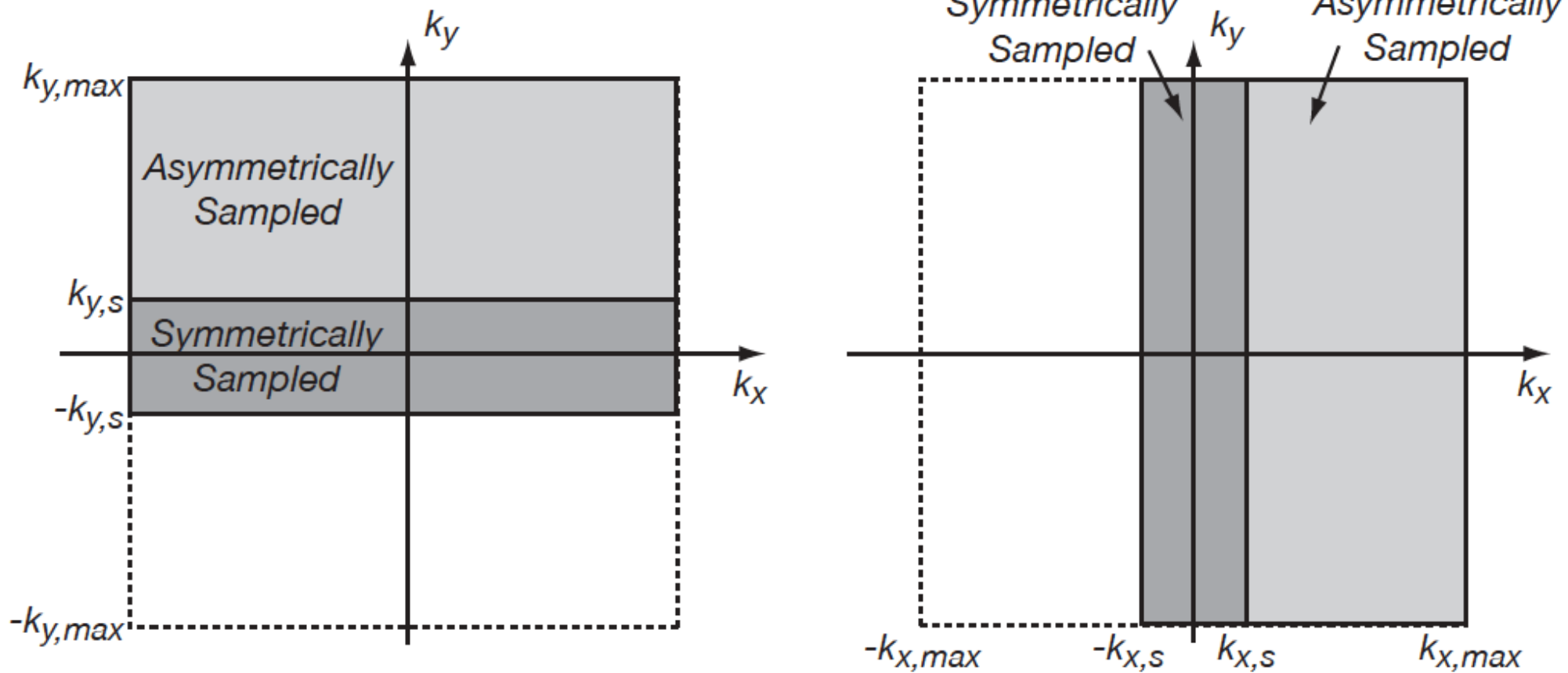

Cartesian 2D Imaging

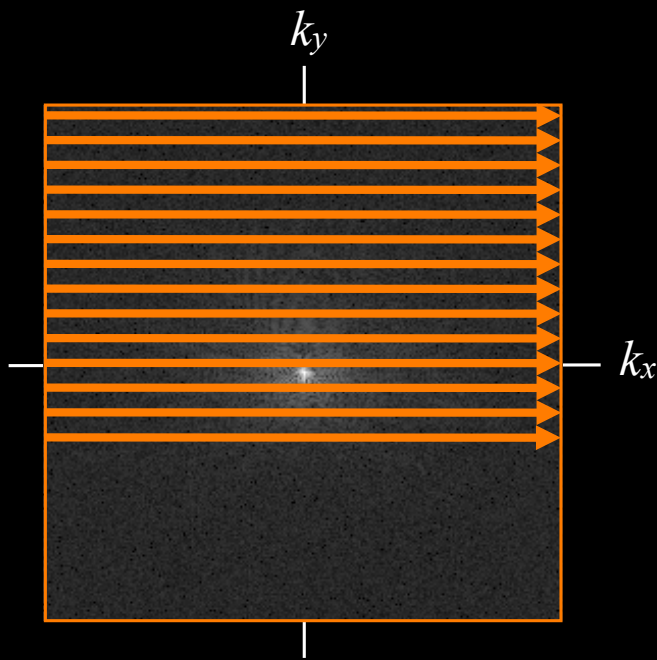

Pulse Sequence Diagram

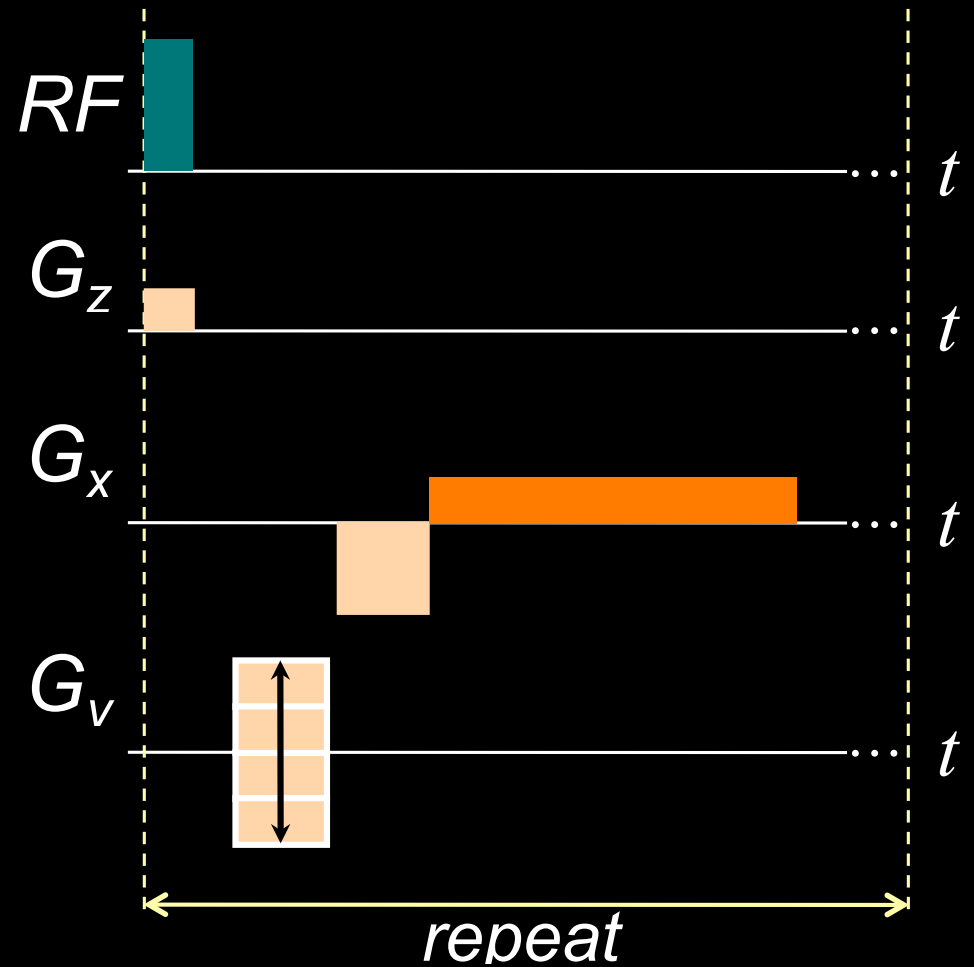

Cartesian 2D Imaging

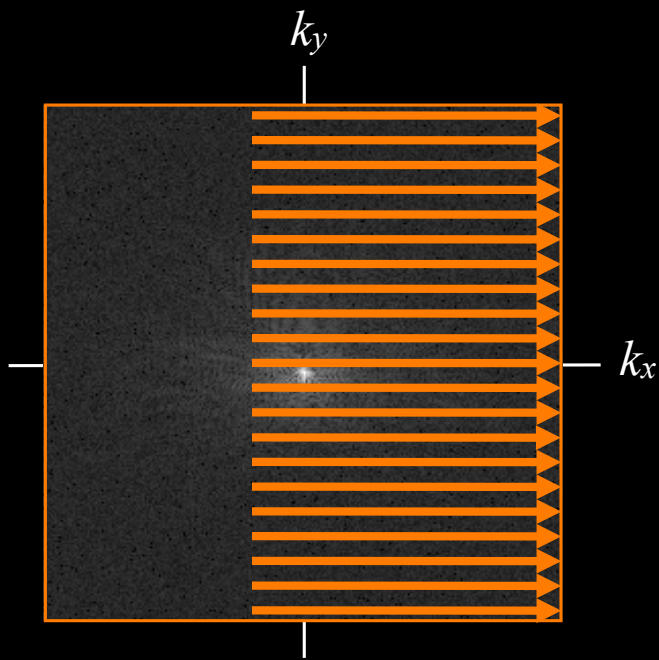

Pulse Sequence Diagram

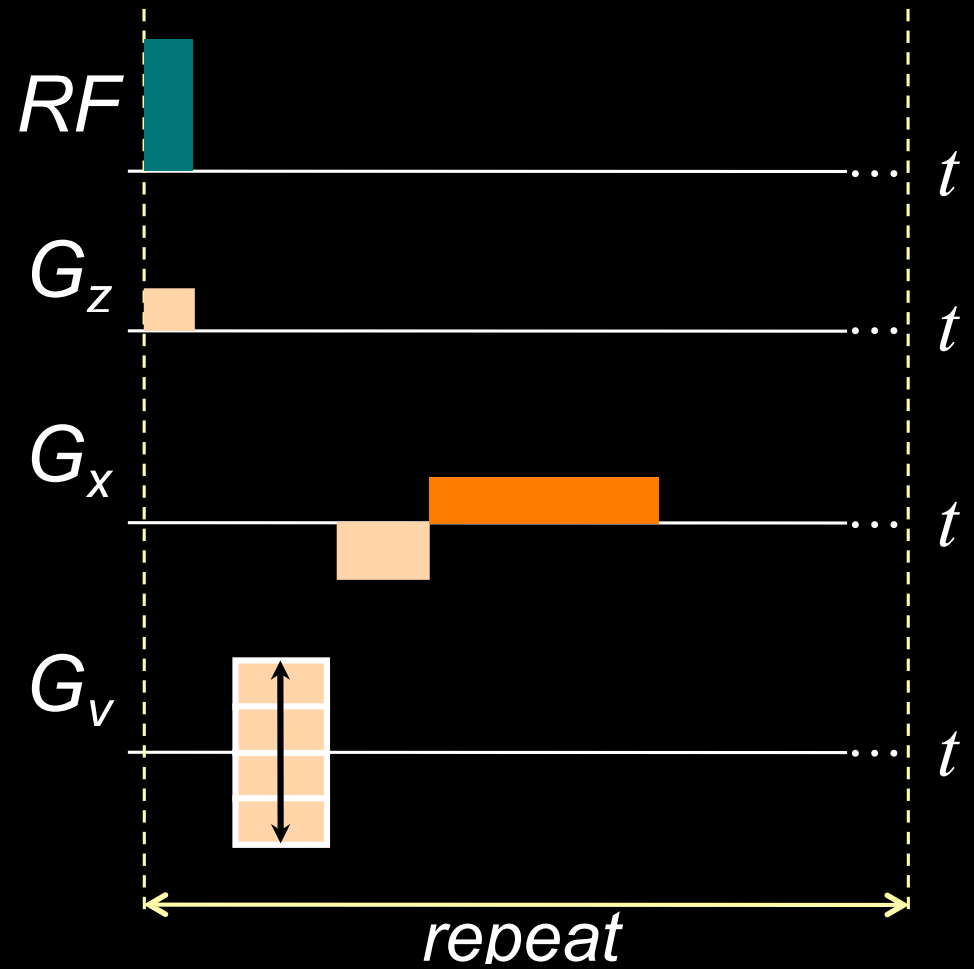

Direct Reconstruction

- Zero padding
- Phase correction and conjugate synthesis
- Homodyne reconstruction

Trivial Recon by Zero-Padding

k-space

Zero Padding

$\frac{9}{16}$

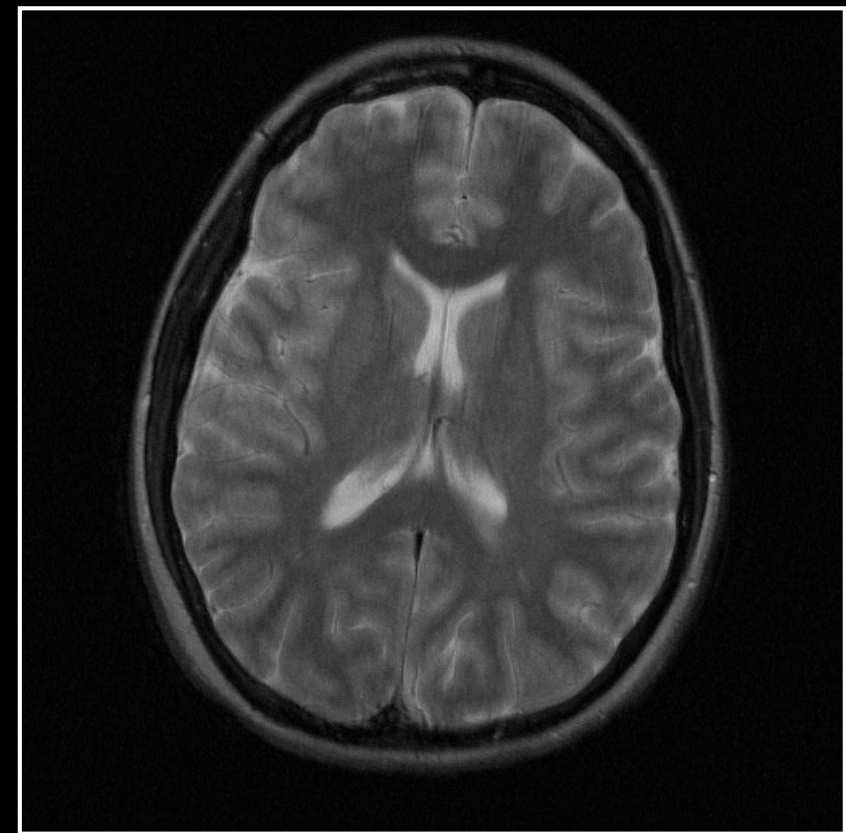
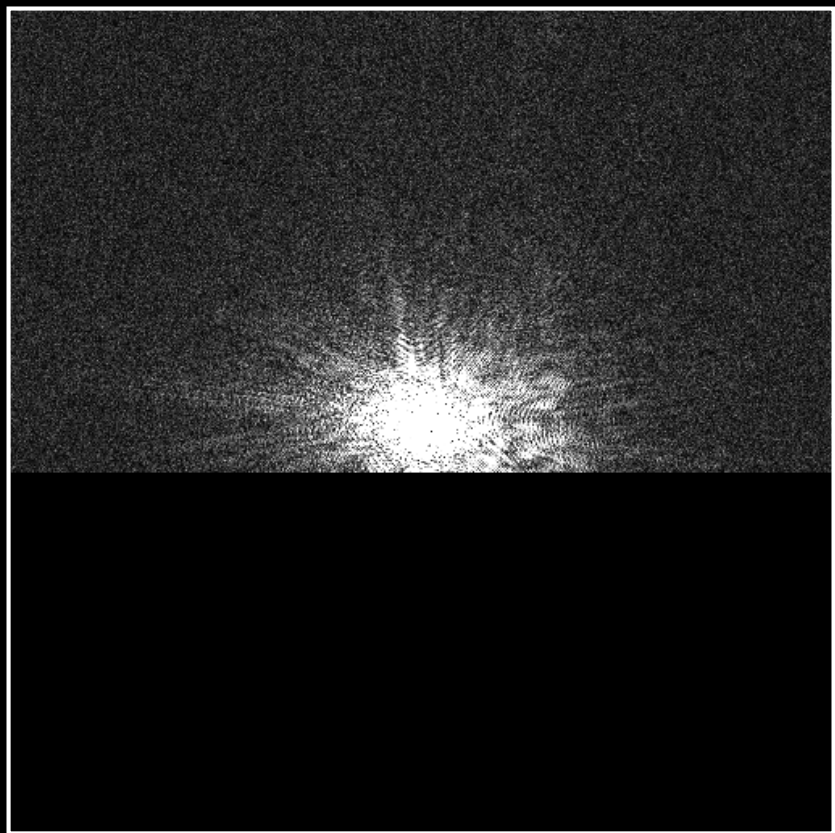

Fourier Transform

Zero Padding

Original

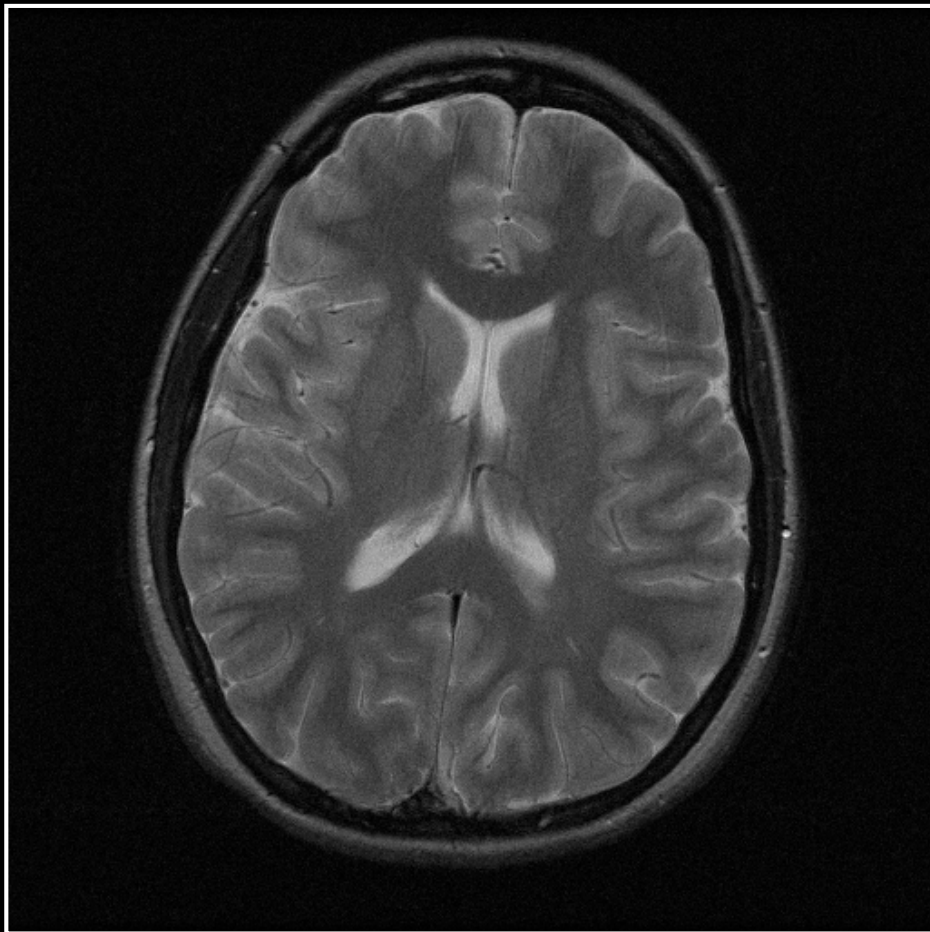

Zero Padding

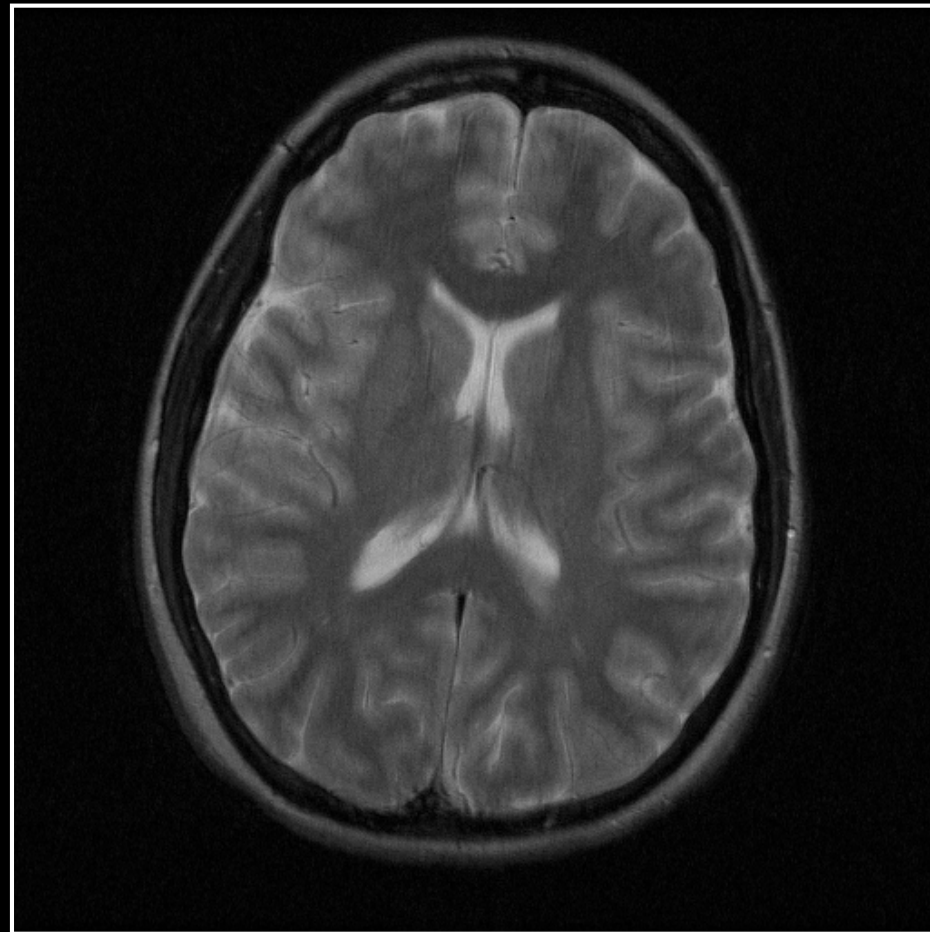
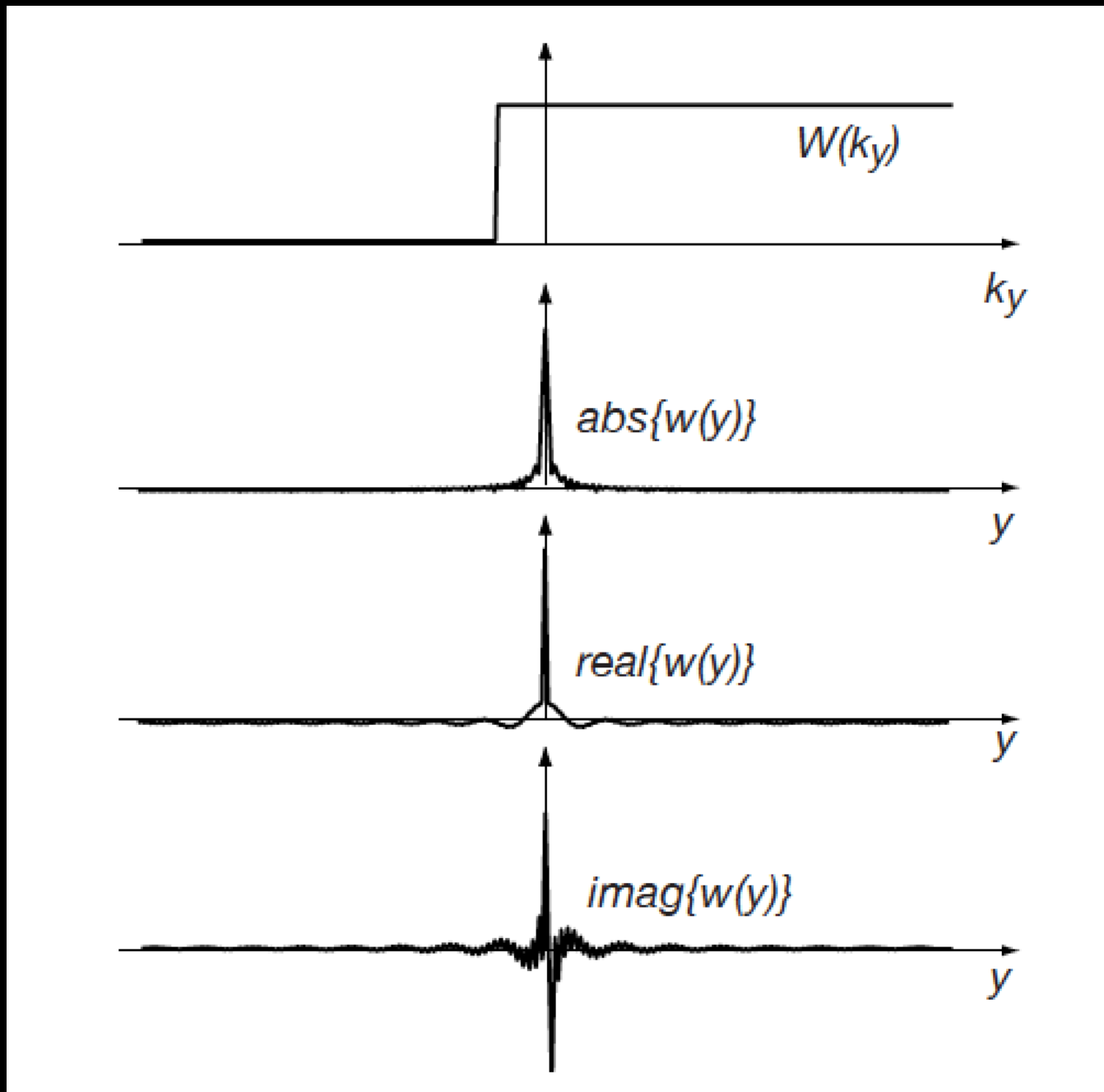

Image Artifacts by Zero Padding

- Blurring can be identified by the product of a full k-space data set multiplied by a weighting function
- The inverse Fourier transform of this weighting function is the impulse response that produces the blurring

Image Artifacts by Zero Padding



Phase Correction and Conjugate Synthesis

- Phase correction must be applied
 - Use the narrow strip of data for which we have symmetric coverage

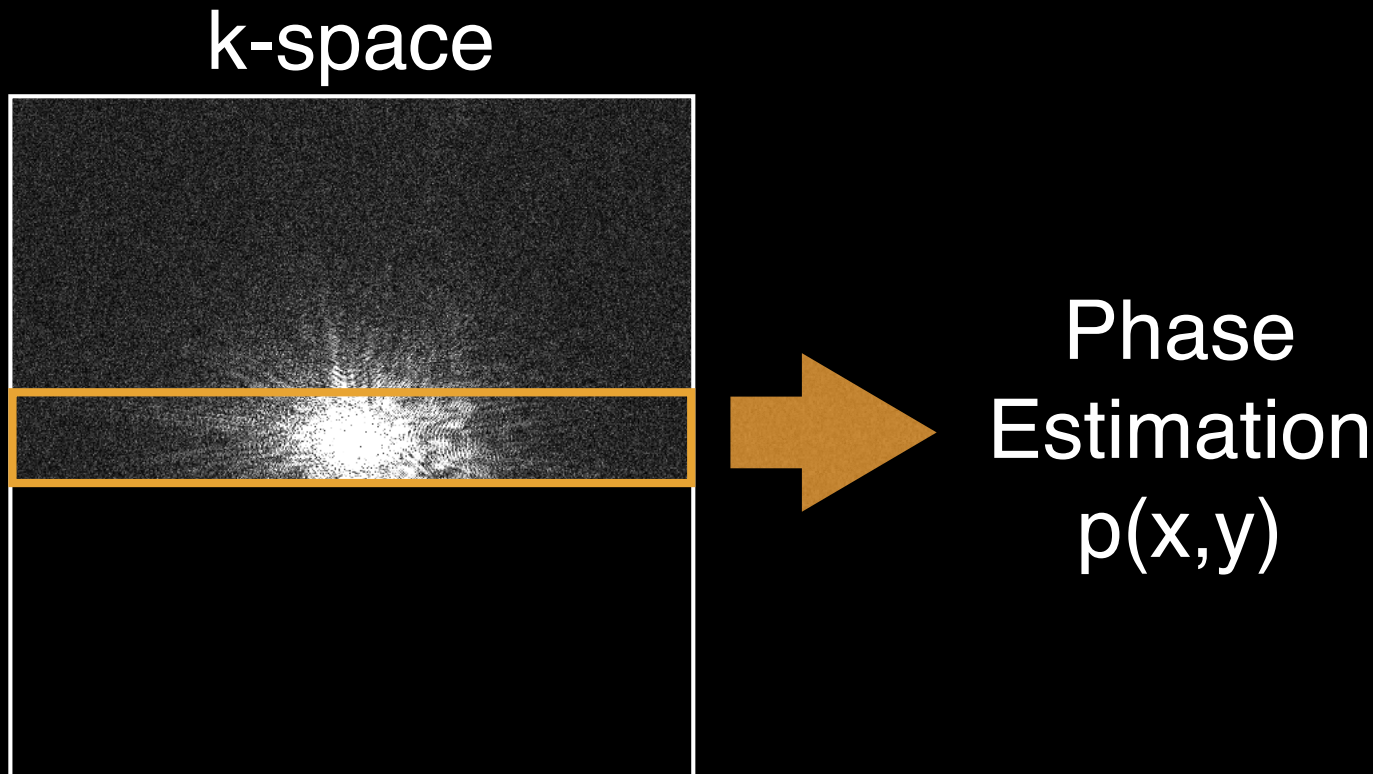

Phase Estimation

Original Phase

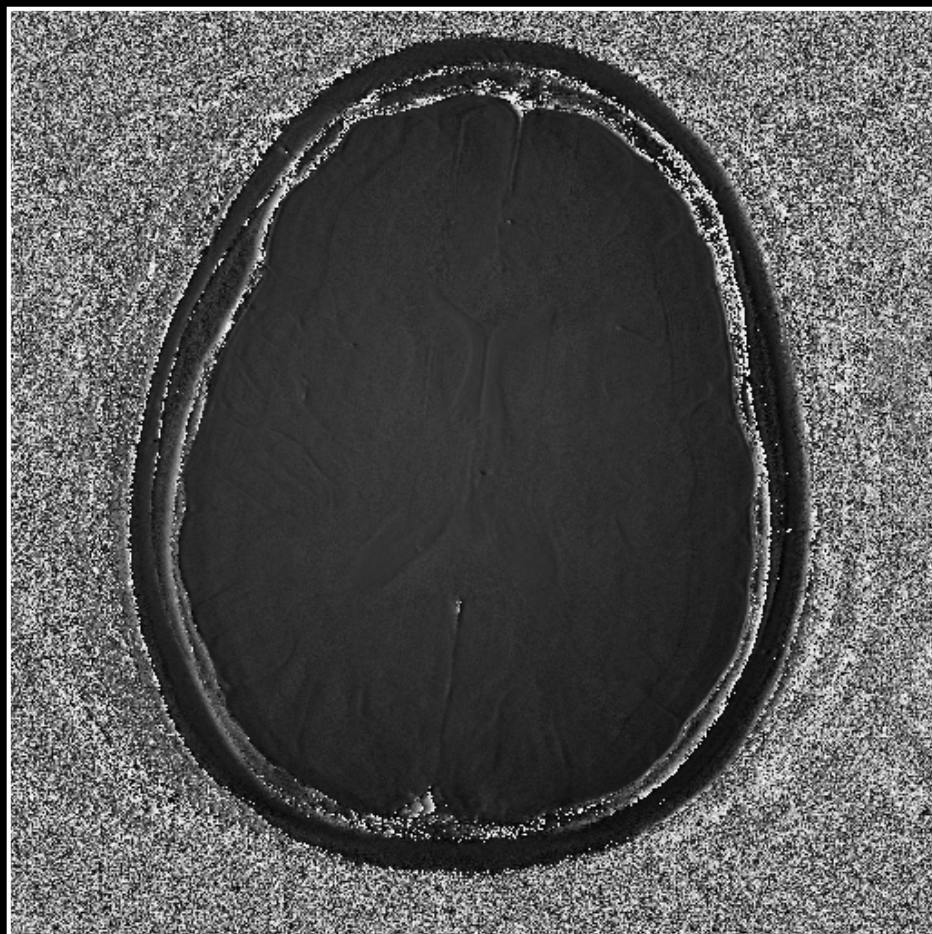

Estimated Phase

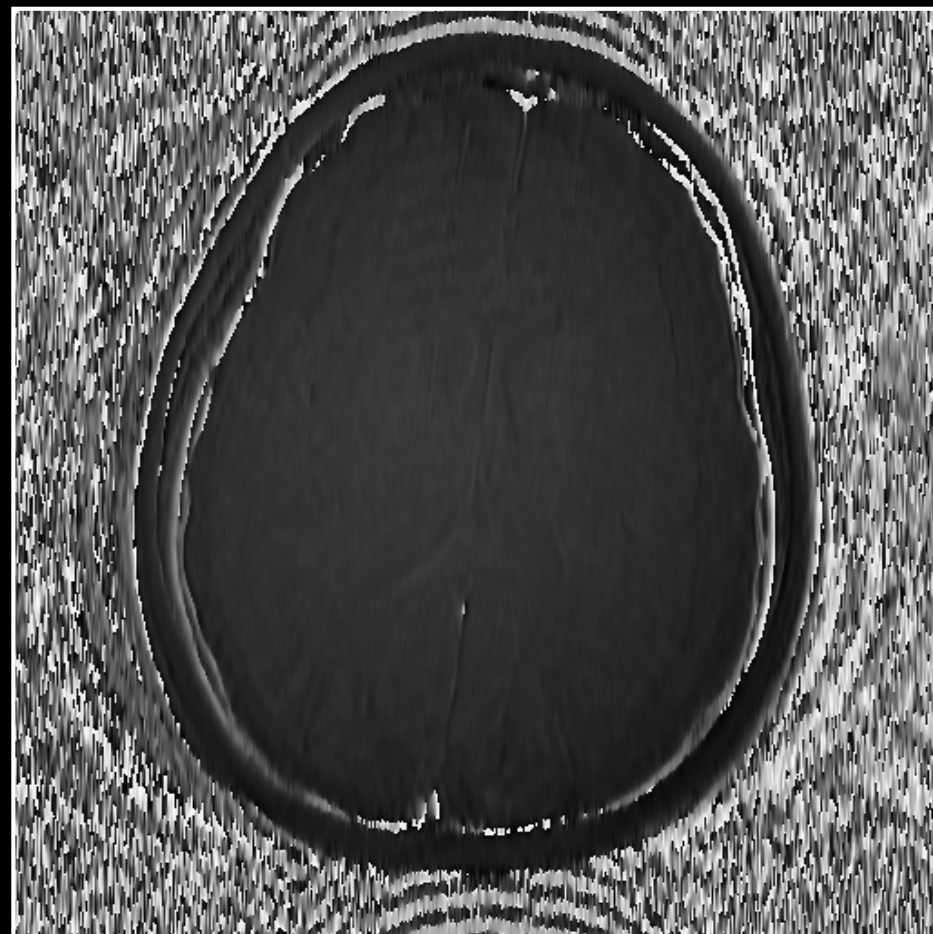

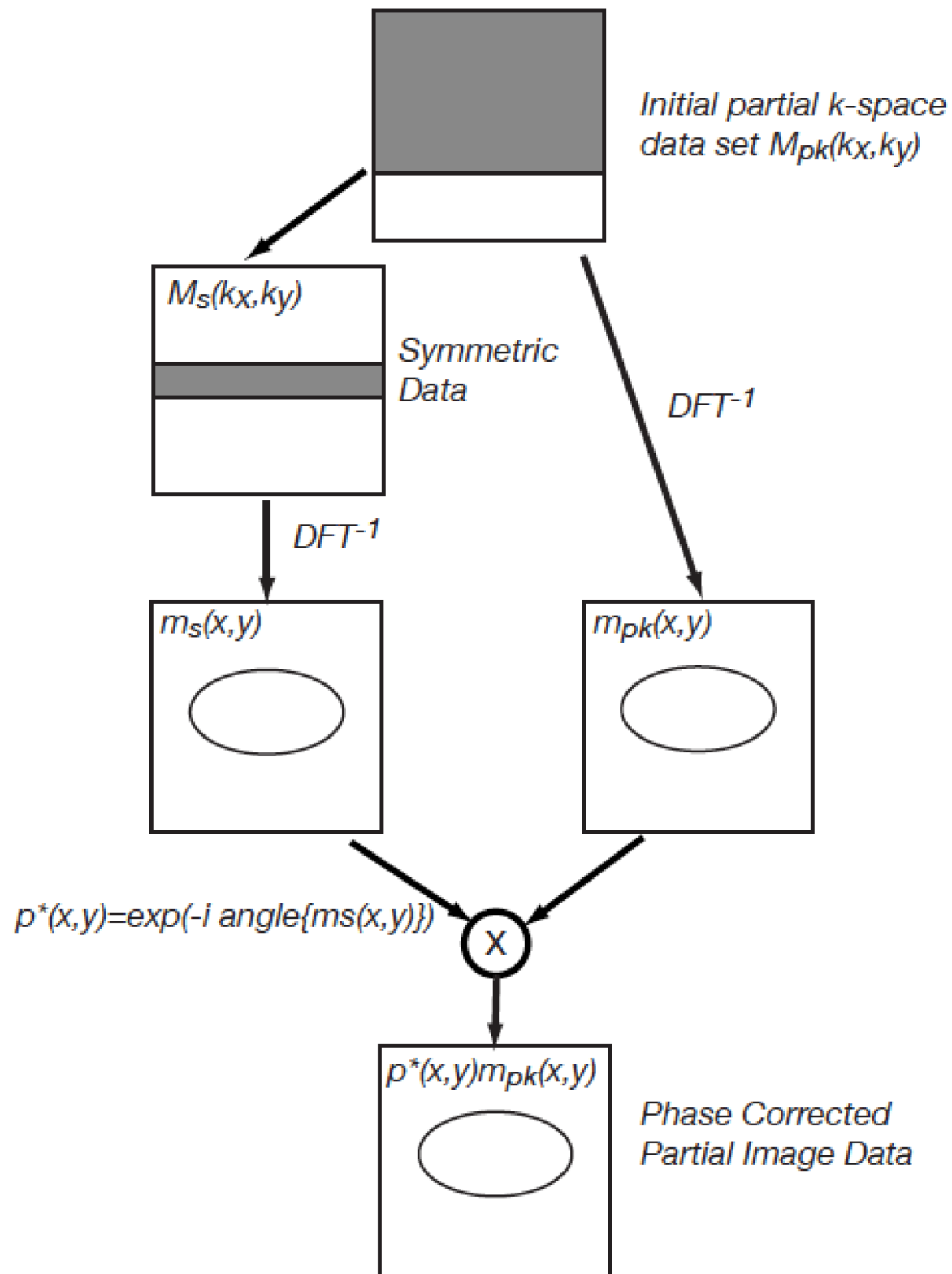

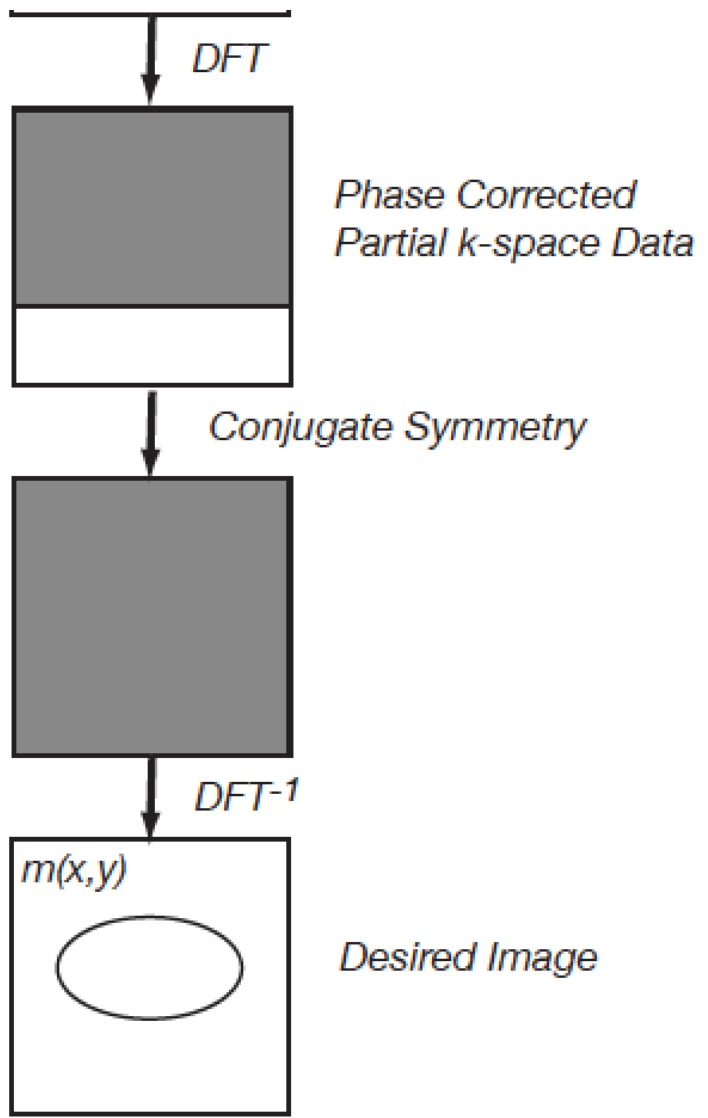

MATLAB Code

```
hnover = 224; % 7/16 sets to be zeros

data_pk = data;
data_pk(1+nx-hnover:end,:) = 0;

im_zp = fftshift(ifftn(fftshift(data_pk)));

data_center = data_pk;
data_center(1:hnover,:) = 0;

im_ph = fftshift(ifftn(fftshift(data_center)));

im_pc = im_zp.*exp(-1i*angle(im_ph));

data_pc = fftshift(fftn(fftshift(im_pc)));
data_pc(1+nx-hnover:end,:) = 0;

data_pc(1+nx-hnover:end,:) = rot90(data_pc(1:hnover,:),2);

im_pc = fftshift(ifftn(fftshift(data_pc)));
```

Phase Correction and Conjugate Synthesis

Original

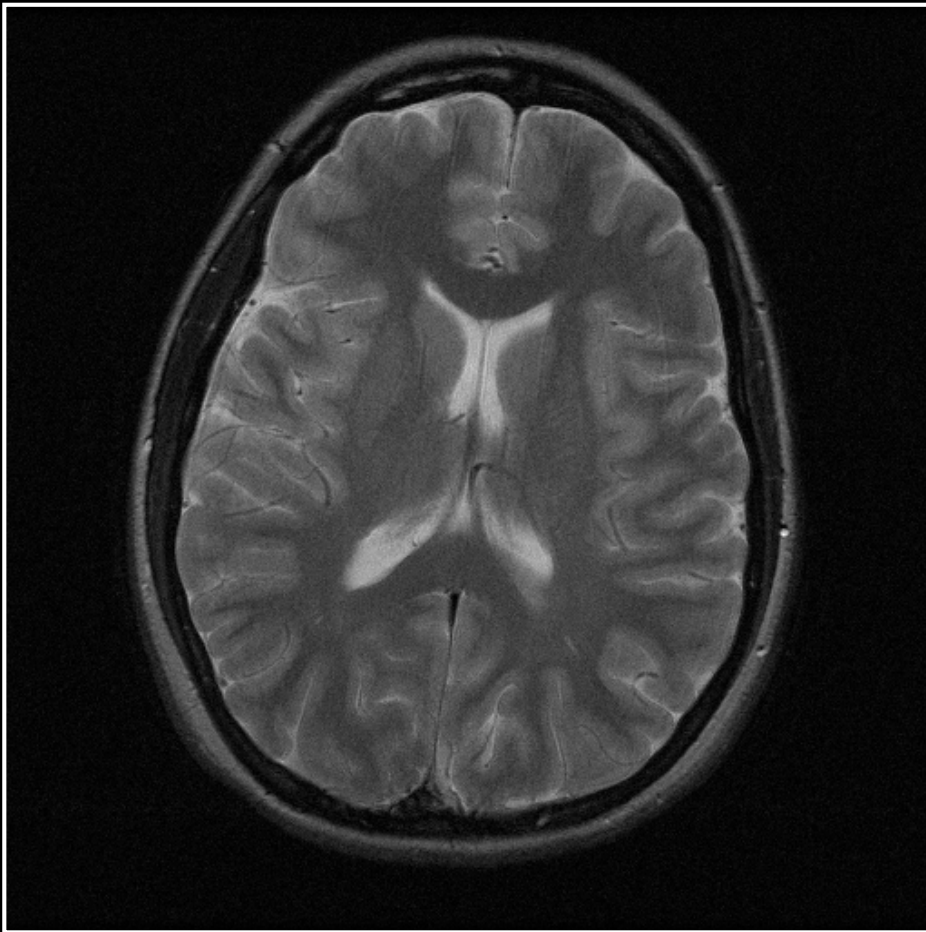

Zero Padding

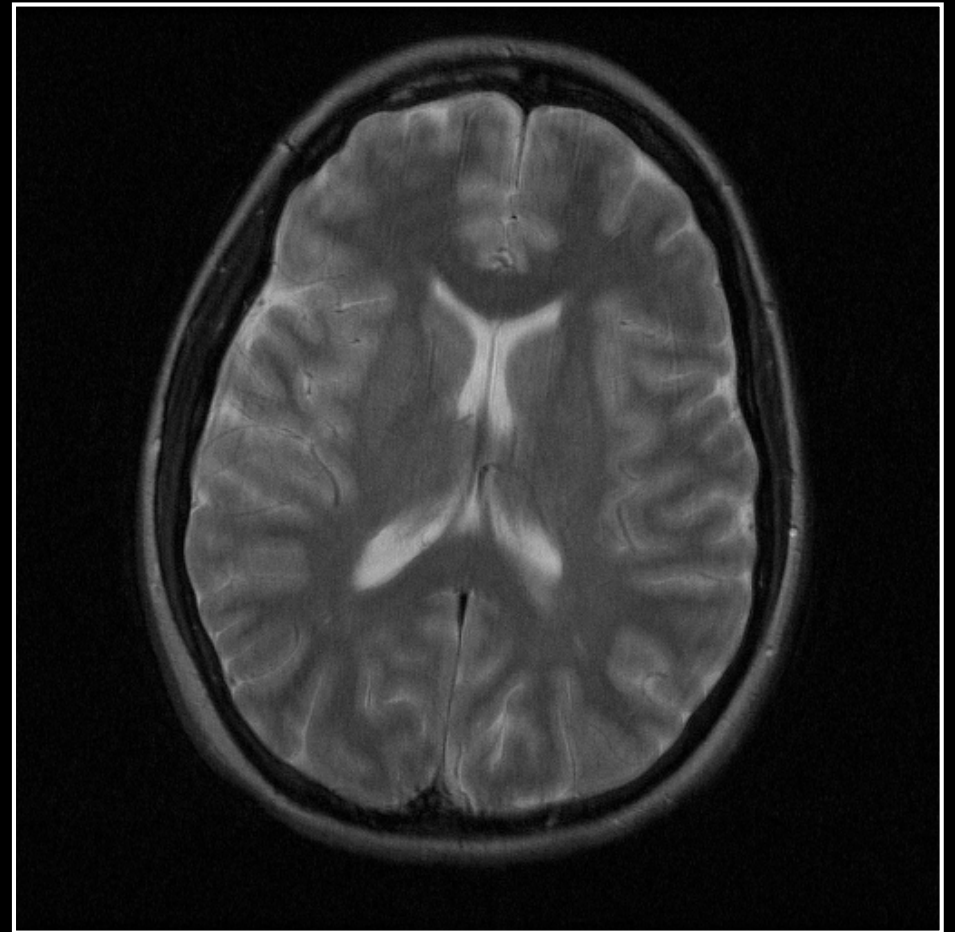

Phase Correction and Conjugate Synthesis

Original

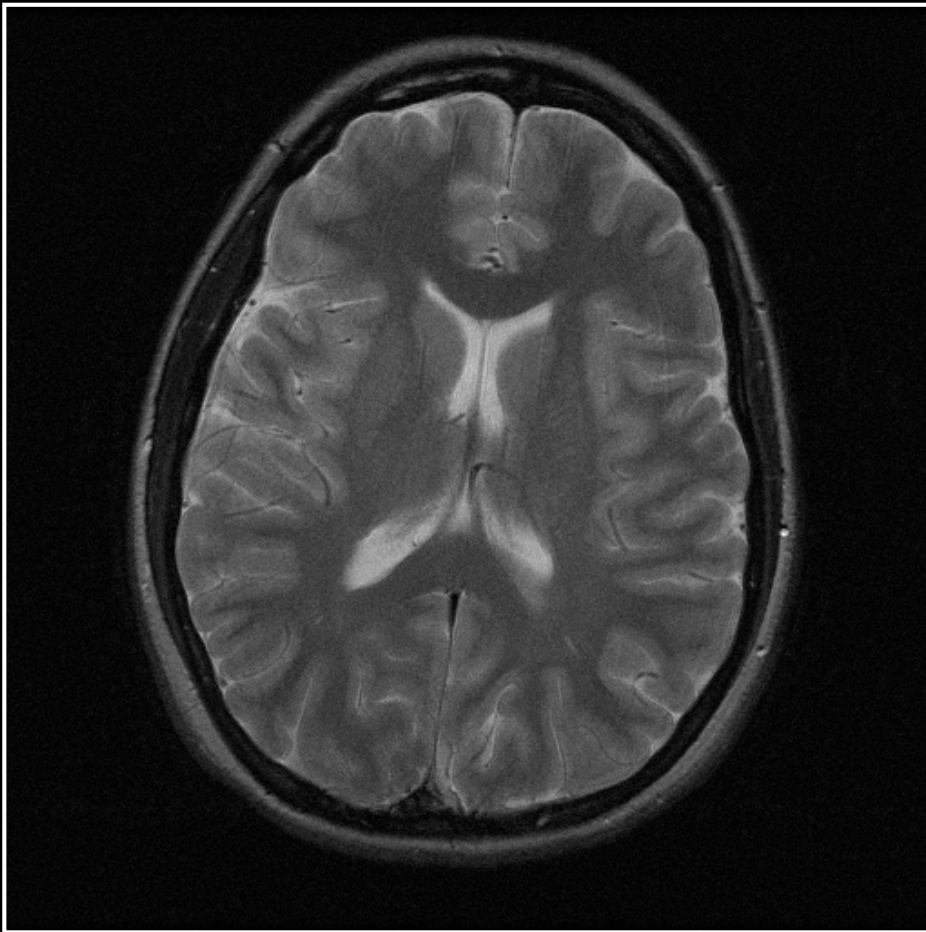

Phase Correction

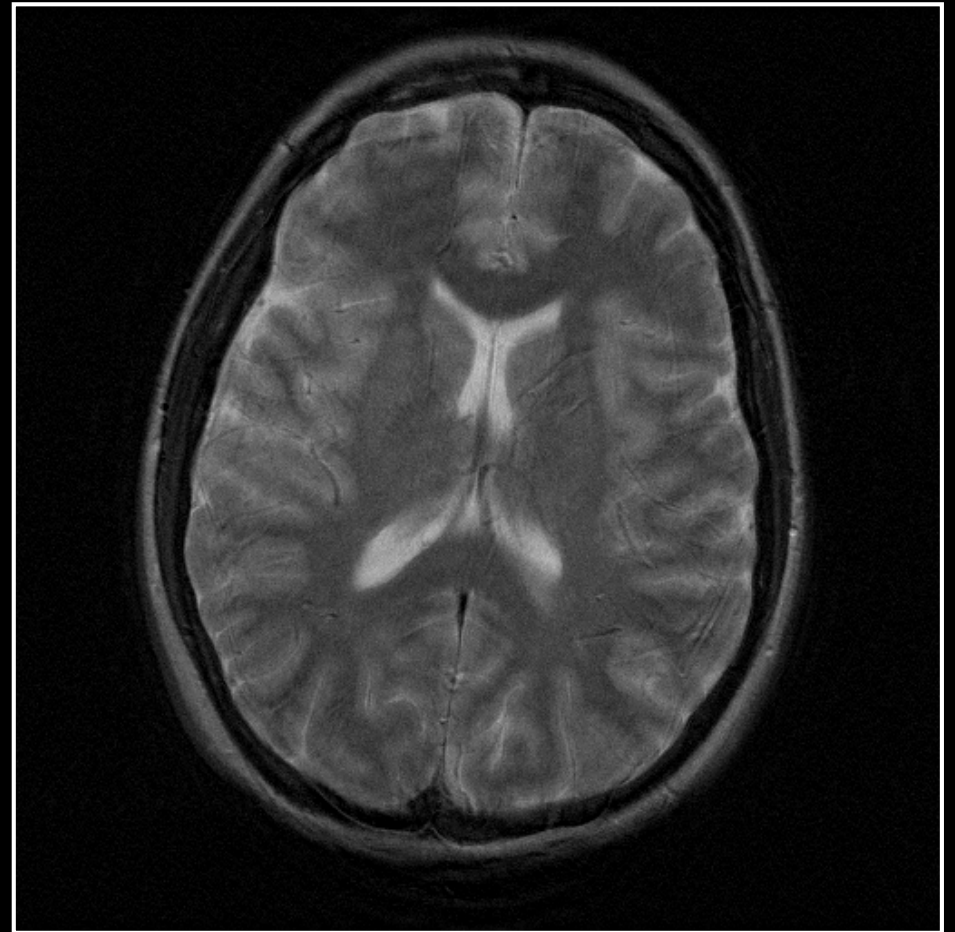

Noise Consideration

- Background in the phase corrected image has lower noise because one component of the complex noise has been suppressed

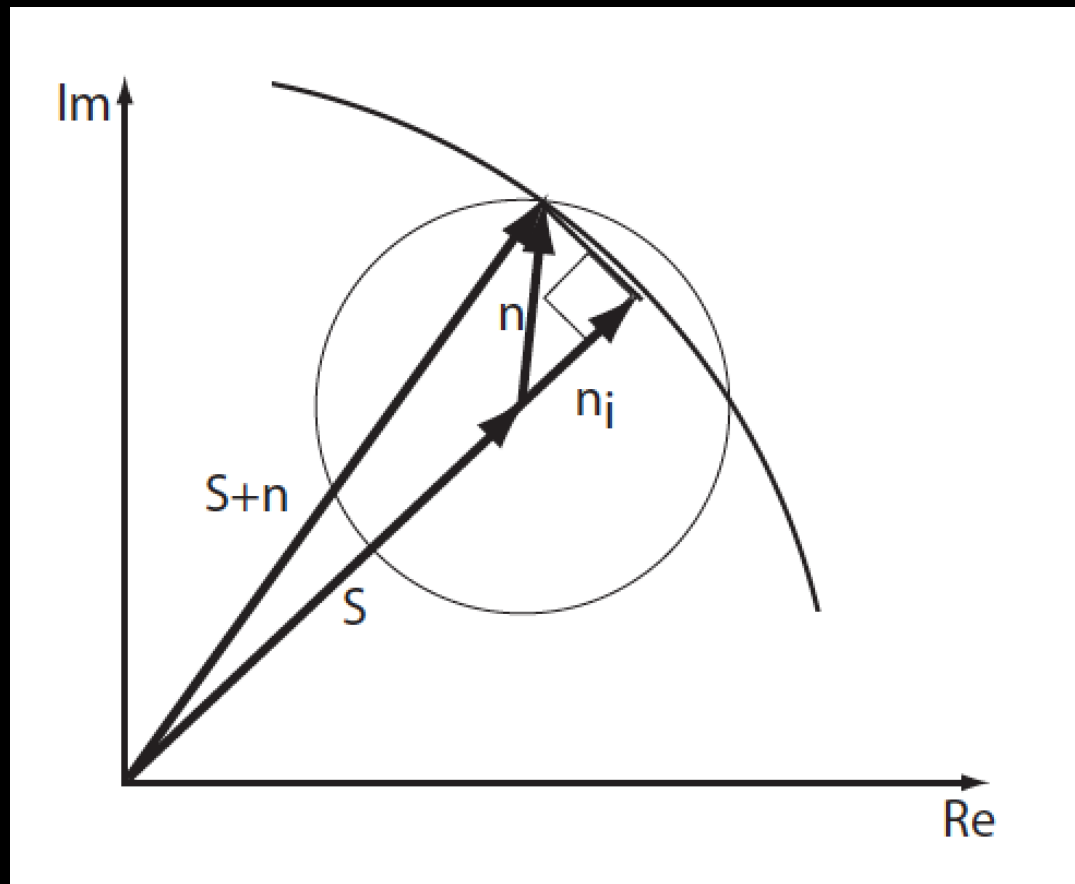

Homodyne Reconstruction

- Real part of an image corresponds to the conjugate symmetric component of the transform
- Imaginary part of an image corresponds to the conjugate anti-symmetric component of the transform

Symmetric and Antisymmetric Components

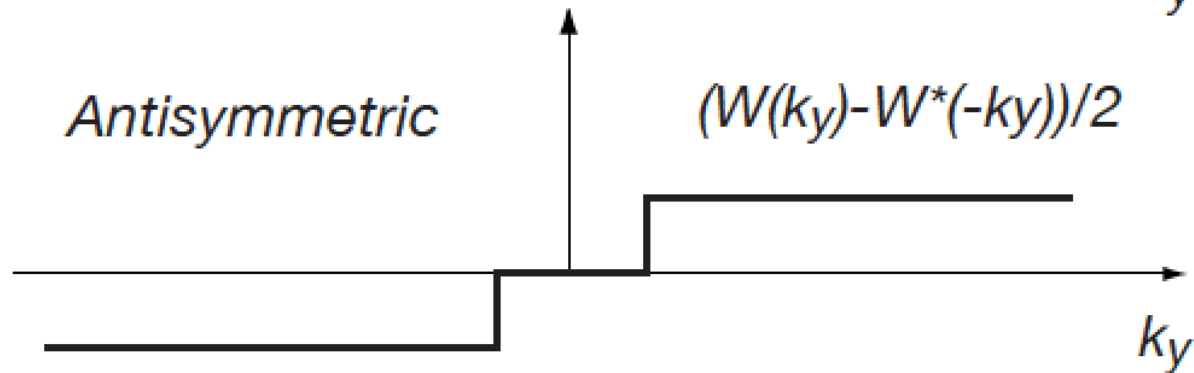
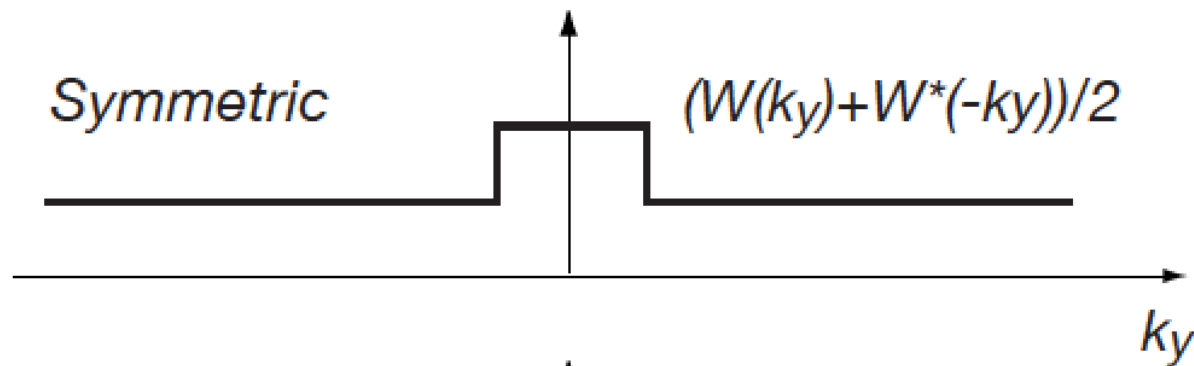
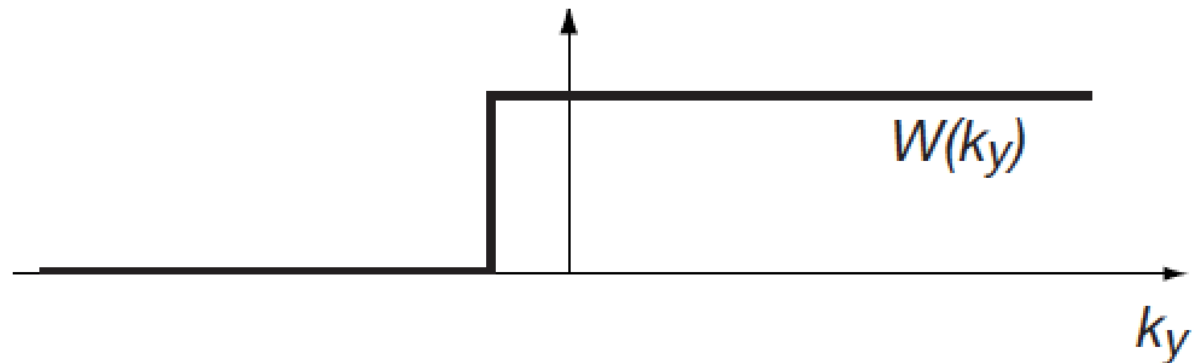

Symmetric and Antisymmetric Components

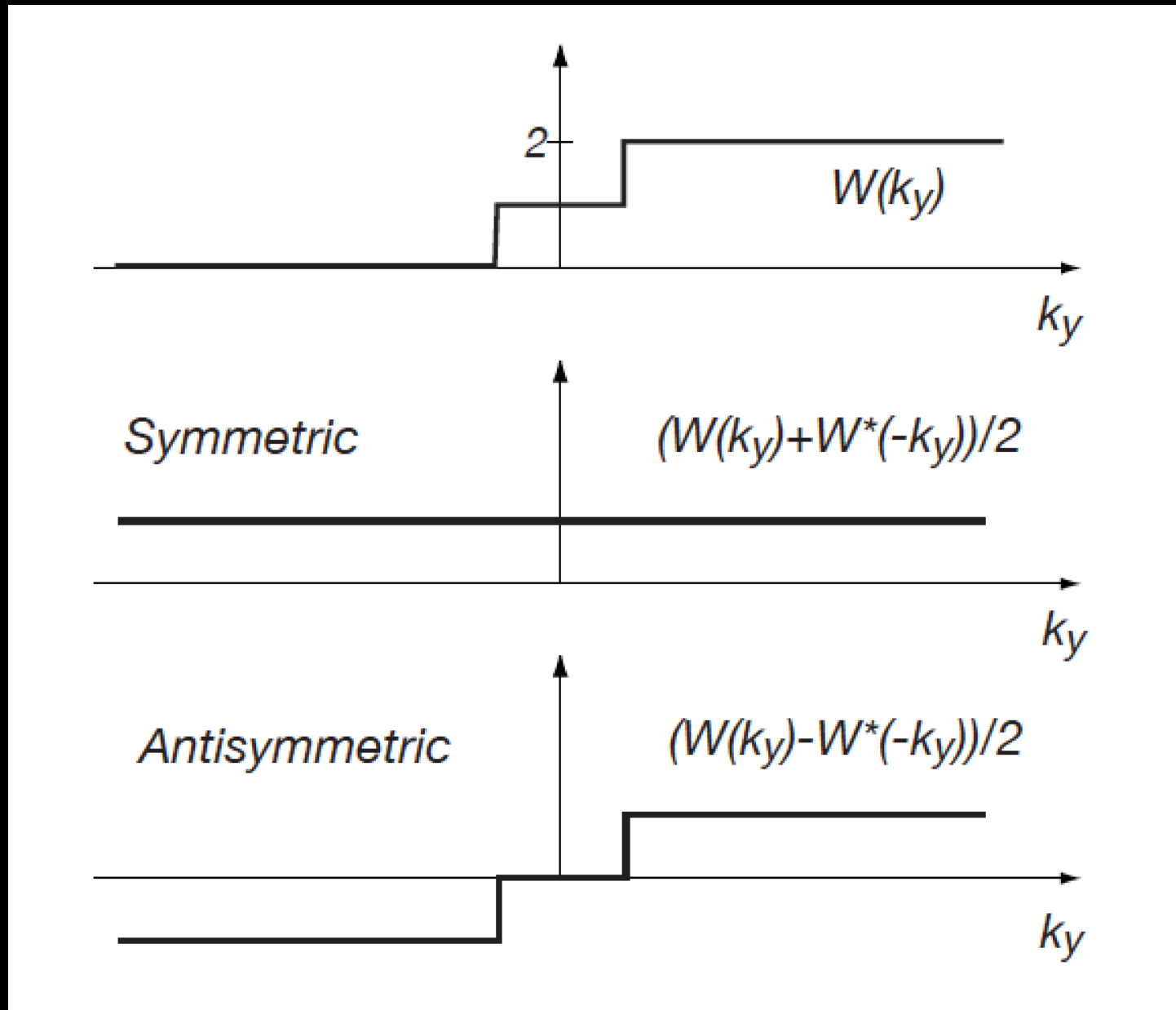

Weighting Function

$$m(x, y) = \text{Re}\{p^*(x, y)(m(x, y) * w(x, y))\}$$

- The phase correction in image space corresponds to a convolution in k-space
- The weighting sharp discontinuities of the weighting function can produce image artifacts

Preferred Weighting Function

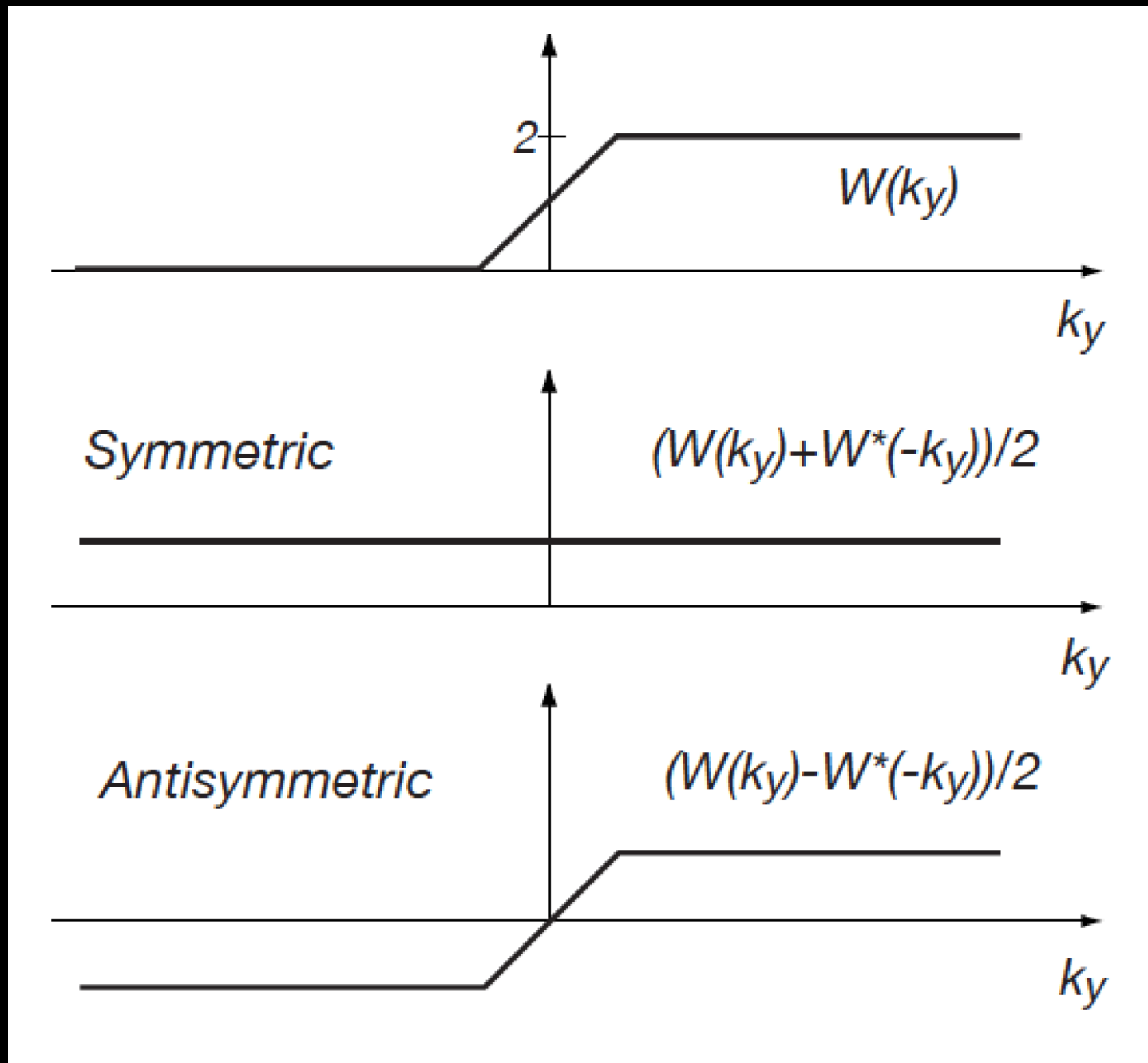

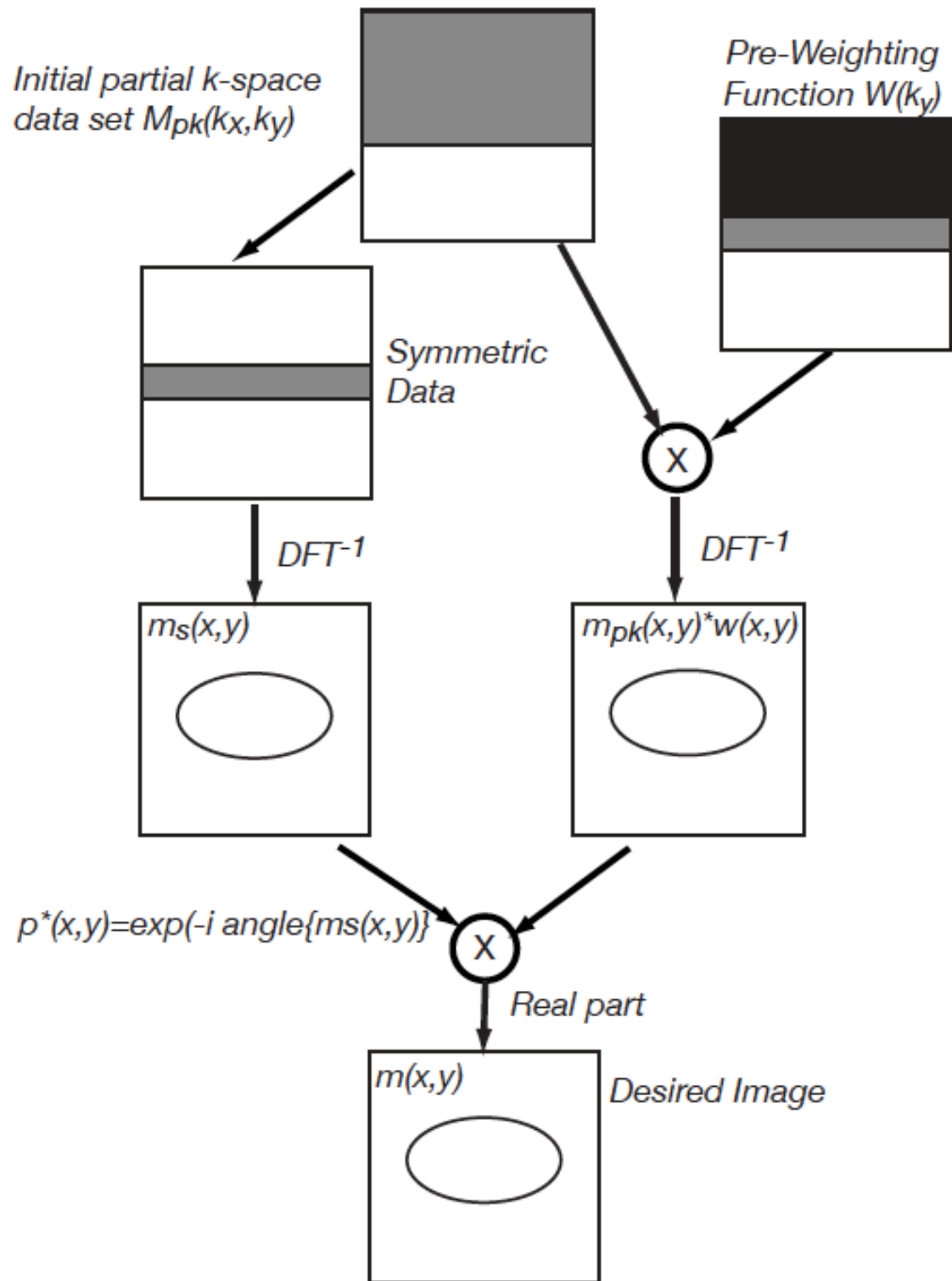

MATLAB Code

```
% Generate pre-weighting function W(ky)
Wld = zeros(nx,1);
Wld(1:hnover) = 2;
Wld(hnover+1:nx-hnover) = 2*(nx-2*hnover-1:-1:0)/(nx-2*hnover);
Wky = repmat(Wld,[1 nx]);

data_pw = data_pk.*Wky;
im_pw = fftshift(ifftn(fftshift(data_pw)));

im_homodyne = im_pw.*exp(-1i*angle(im_ph));
```

Homodyne Reconstruction

Original

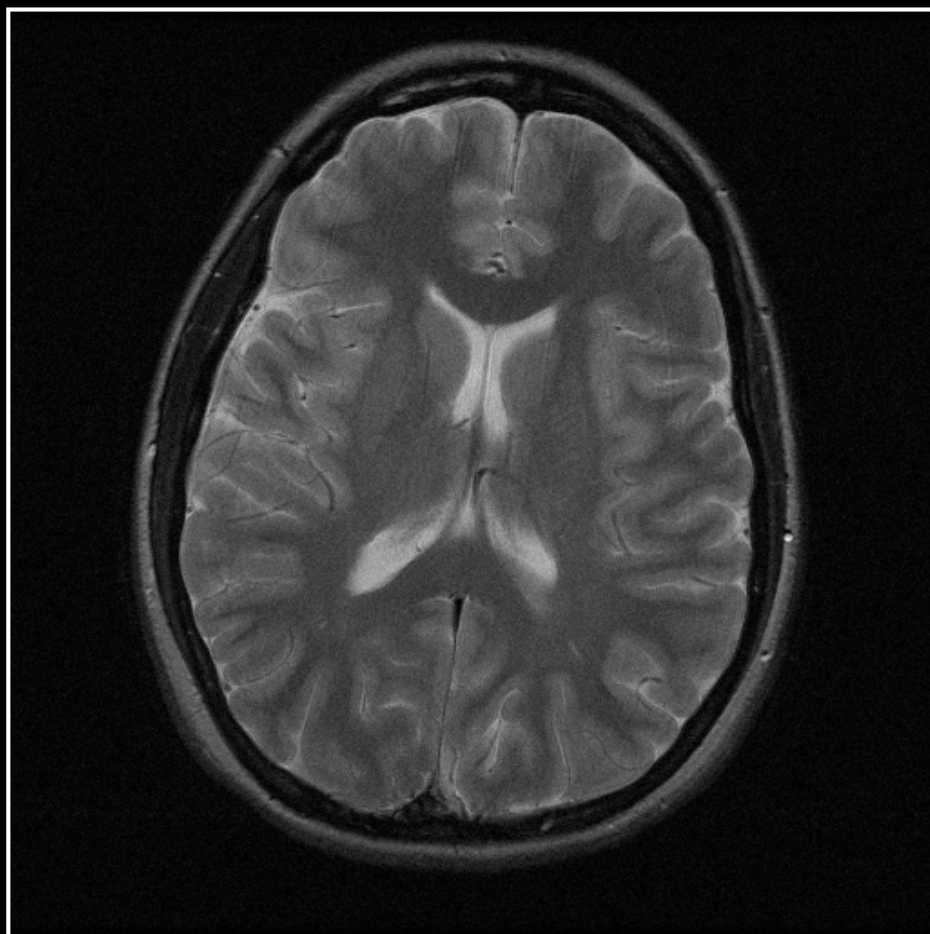

Phase Correction

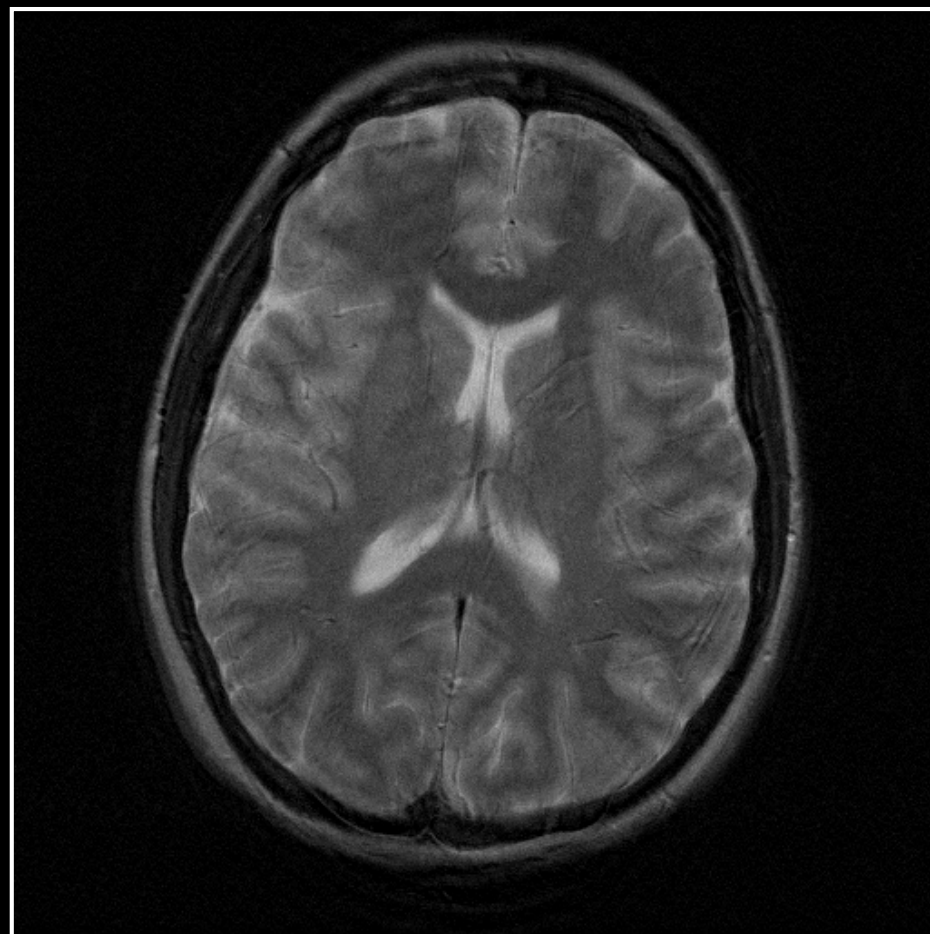

Homodyne Reconstruction

Original

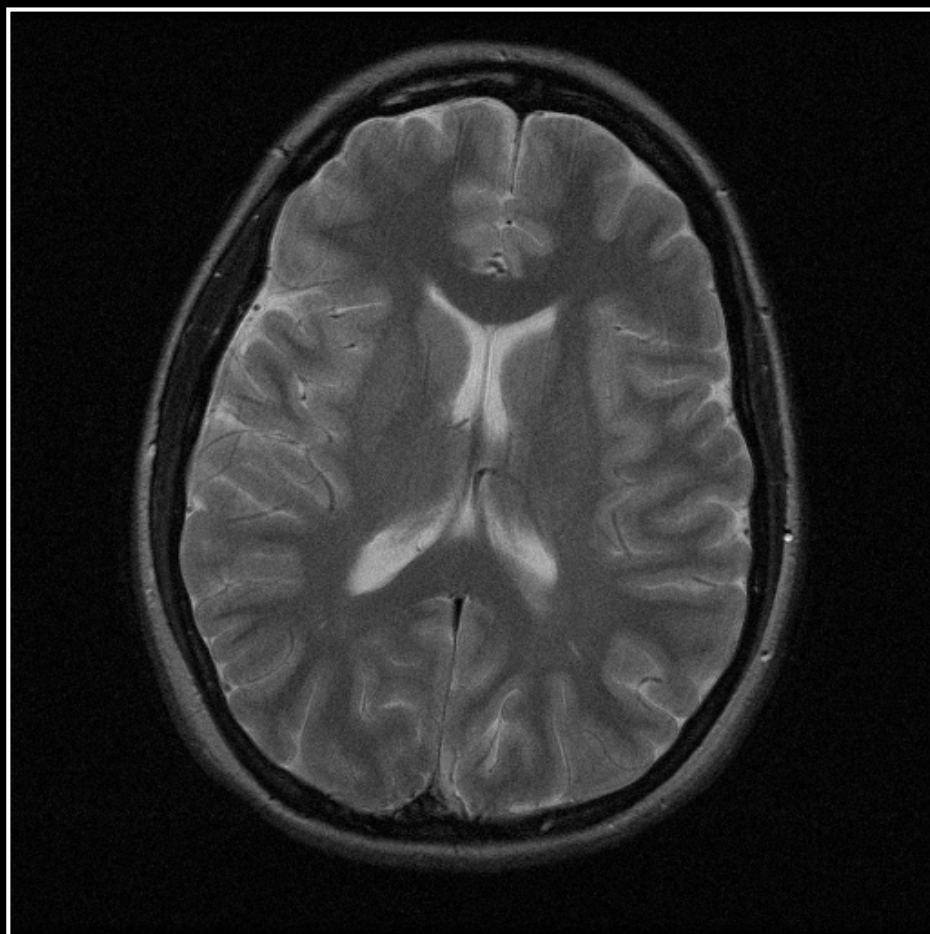

Homodyne Recon

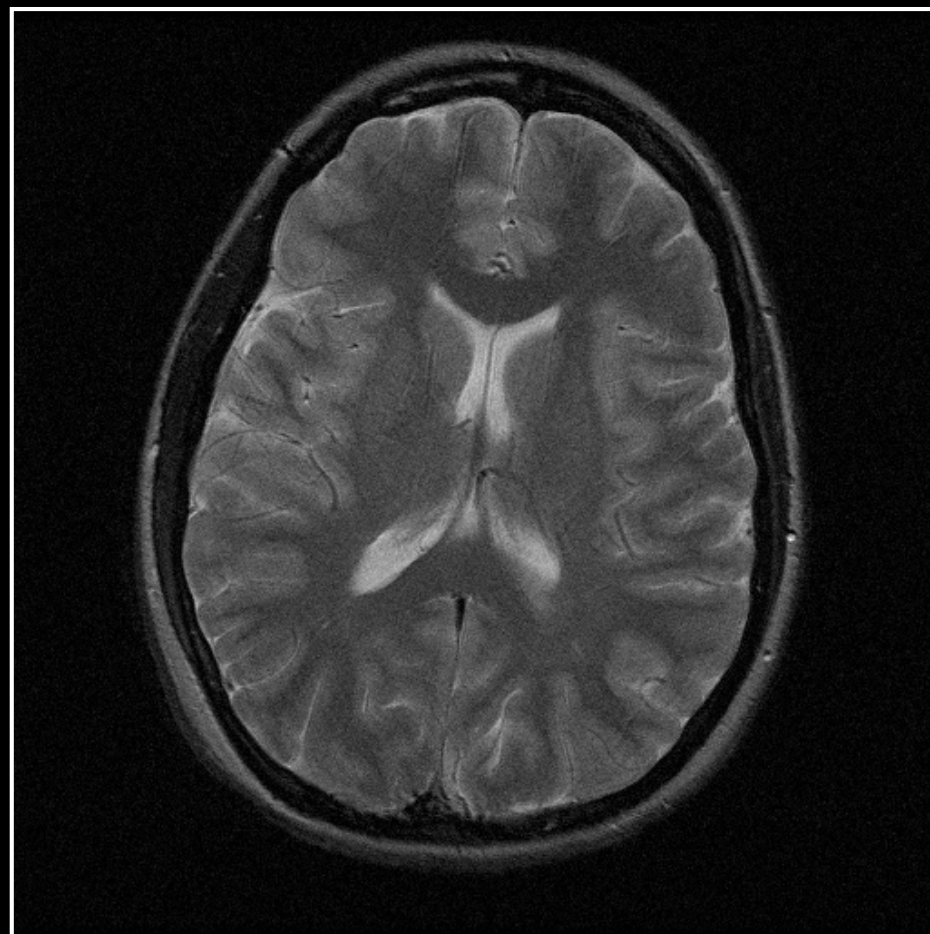

Summary of Direct Methods

- Both homodyne and phase corrected conjugate synthesis approaches work well if image phase does not vary rapidly
- Problems with phase corrected conjugate synthesis approach are due to performing the conjugate synthesis after the phase correction

Iterative Reconstruction

$$m_i(x, y) = |m_i(x, y)|p(x, y)$$

- Estimate the missing k-space data by iteratively applying phase correction and conjugate synthesis
- In the image domain, the image phase is constrained to be that of the low resolution estimate
- In the frequency domain, the k-space data is constrained to match the acquired data when available

Projection Onto Convex Set (POCS)

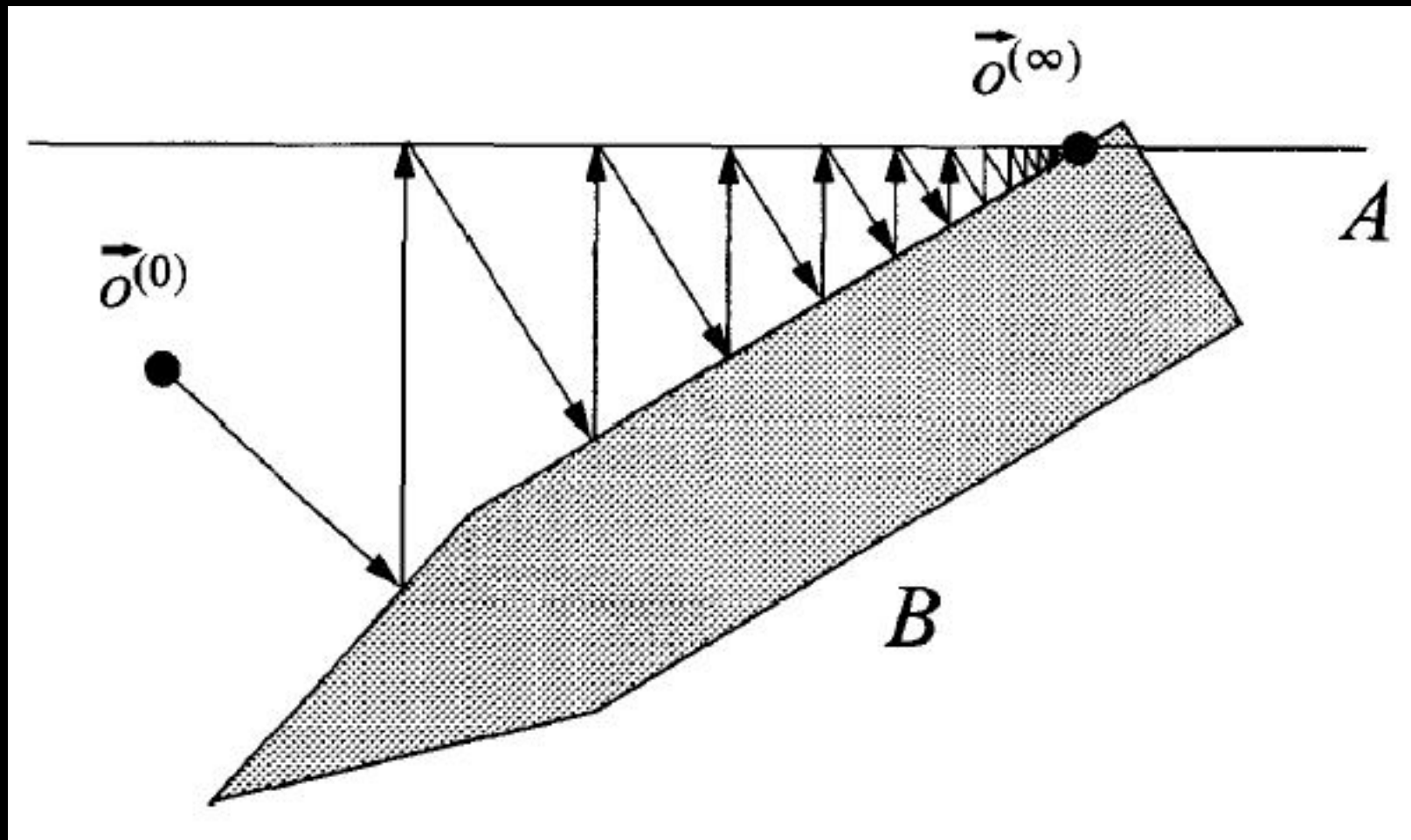

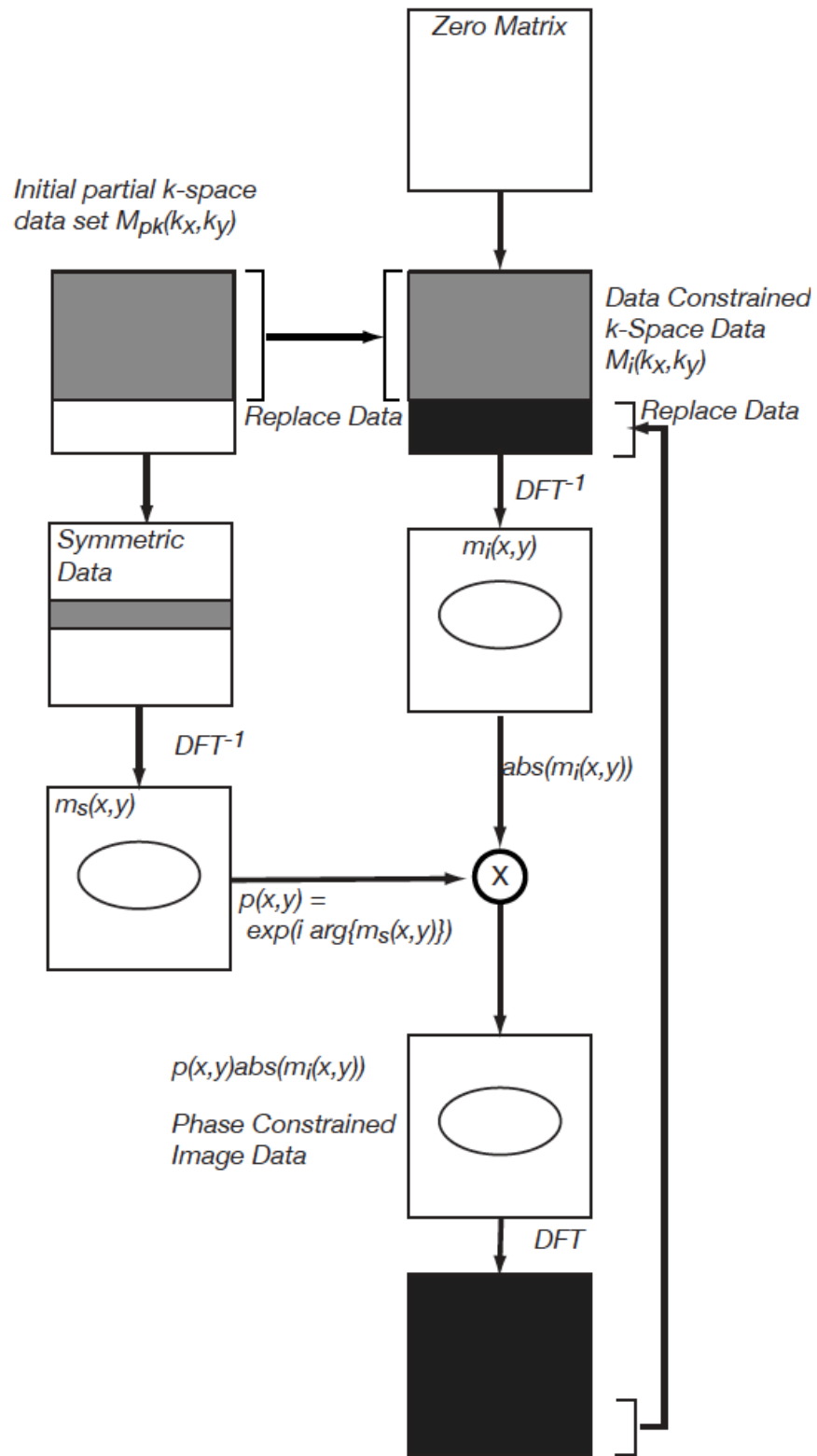

MATLAB Code

```
threshold_pocs = 0.001;

% Zero padding for initial guess
im_init = fftshift(ifftn(fftshift(data_pk))); % Inverse DFT
% Take only magnitude term & Apply phase term
im_init = abs(im_init).*exp(1i*angle(im_ph));

% FFT
tmp_k = fftshift(fftn(fftshift(im_init)));
diff_im = threshold_pocs + 1;

while (abs(diff_im) > threshold_pocs)
    tmp_k(1:nx-hnover,:) = data_pk(1:nx-hnover,:);
    tmp_im = fftshift(ifftn(fftshift(tmp_k))); % Inverse DFT

    % Take only magnitude term & Apply phase term
    tmp_im = abs(tmp_im).*exp(1i*angle(im_ph));
    tmp_k = fftshift(fftn(fftshift(tmp_im)));

    % Compare the reconstructed image
    diff_im = abs(tmp_im - im_init);
    diff_im = sum(diff_im(:).^2);
    fprintf('Difference is %f\n',diff_im);

    im_init = tmp_im;
end

im_pocs = tmp_im;
```

POCS Reconstruction

Original

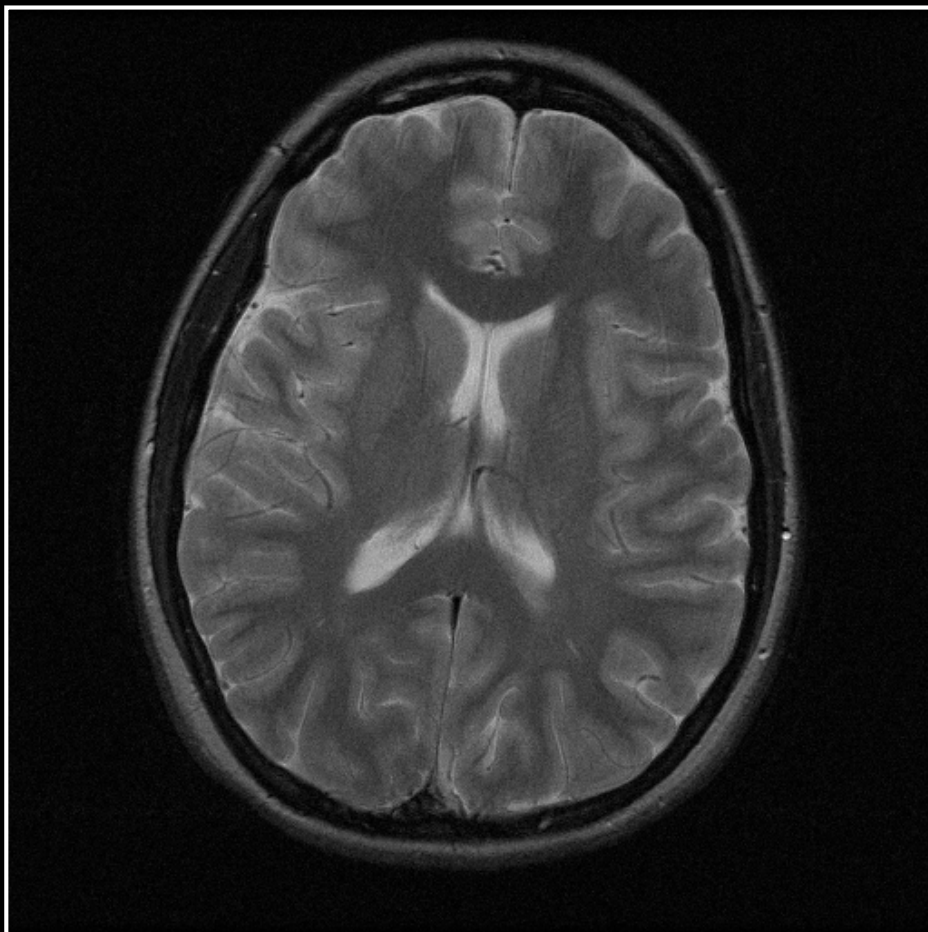

POCS Recon

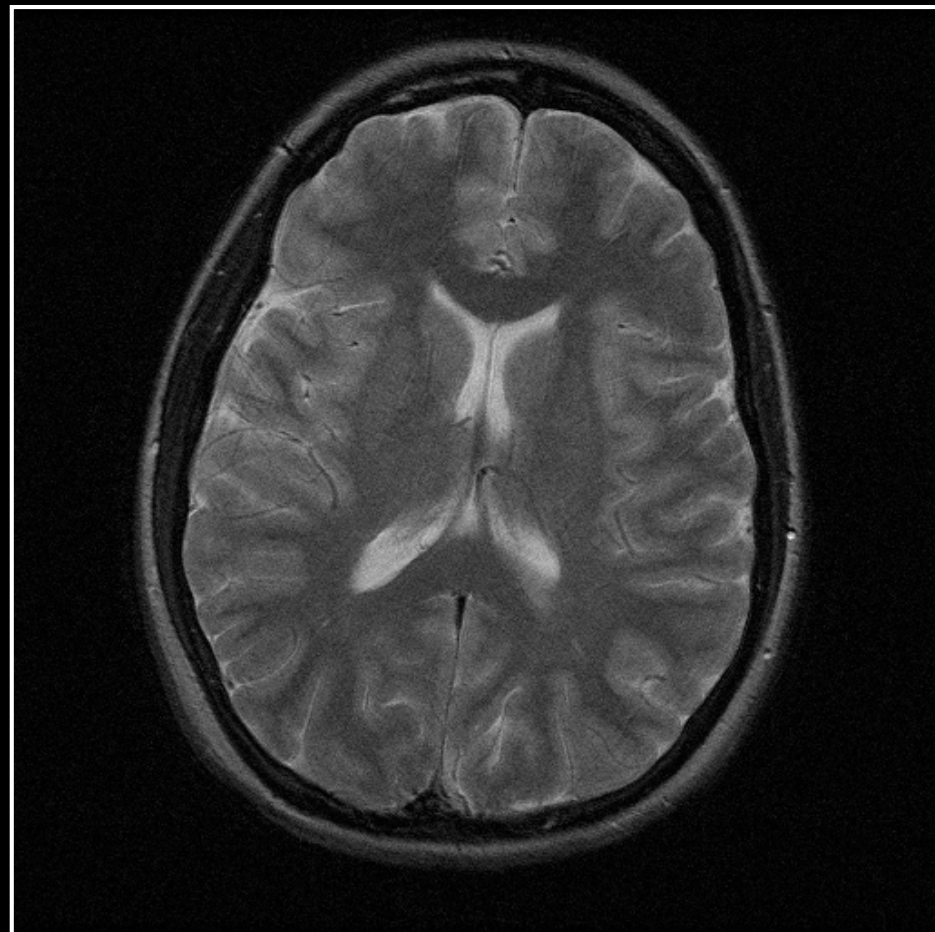

Original

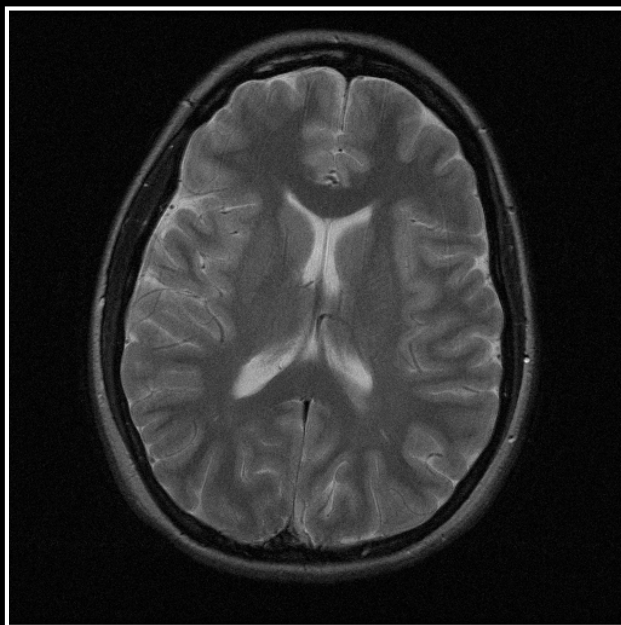

Phase Correction

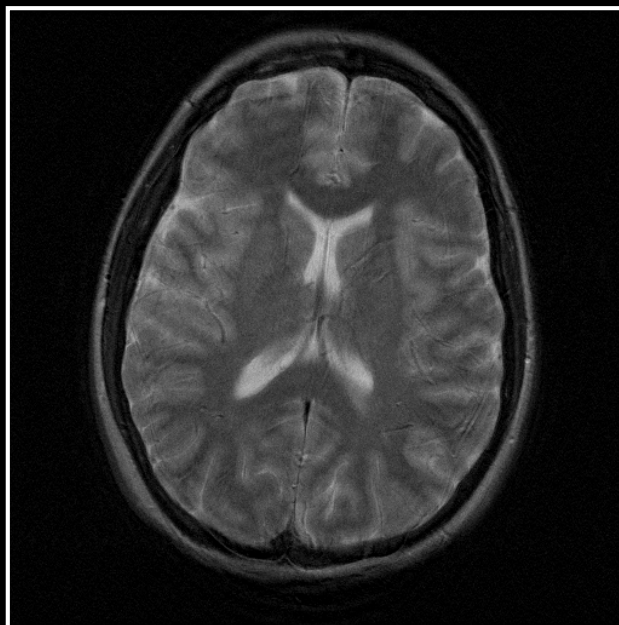

Homodyne

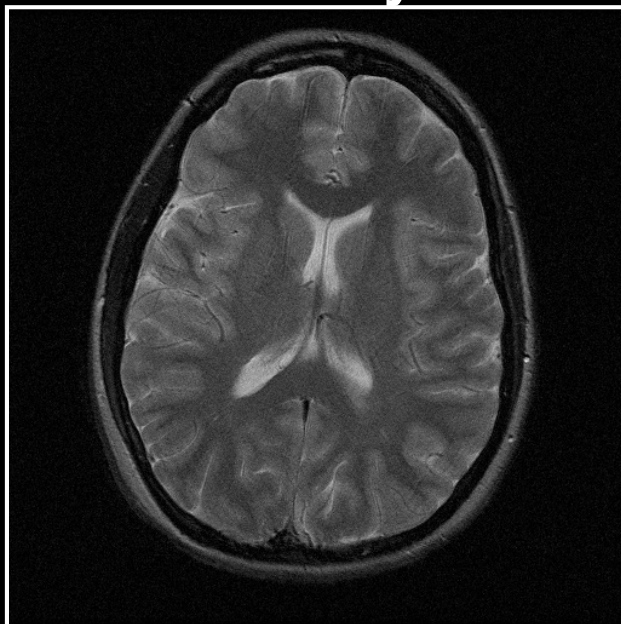

POCS

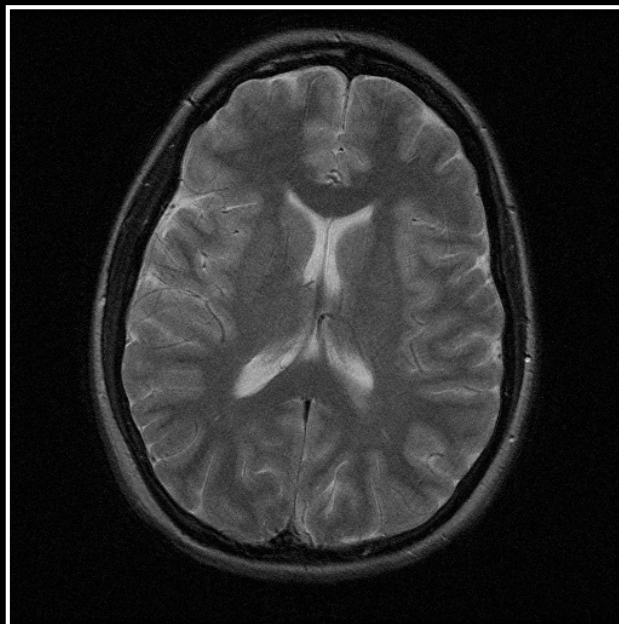

Conclusions

- All of these algorithms work well when the image phase variations are smooth
- When the image phase changes rapidly, the homodyne algorithm produces ghosting
- POCS algorithm performs somewhat better as the k-space fraction decreases

Thanks!

- Next time:
 - Parallel Imaging
 - Read “Parallel Imaging Reconstruction”
p522-544

Kyung Sung, PhD

ksung@mednet.ucla.edu

<http://kyungs.bol.ucla.edu>