

# MR Spectroscopic Imaging

M. Albert Thomas  
Professor

Department of Radiological Sciences  
University of California Los Angeles (UCLA)  
[athomas@mednet.ucla.edu](mailto:athomas@mednet.ucla.edu)



Third Edition

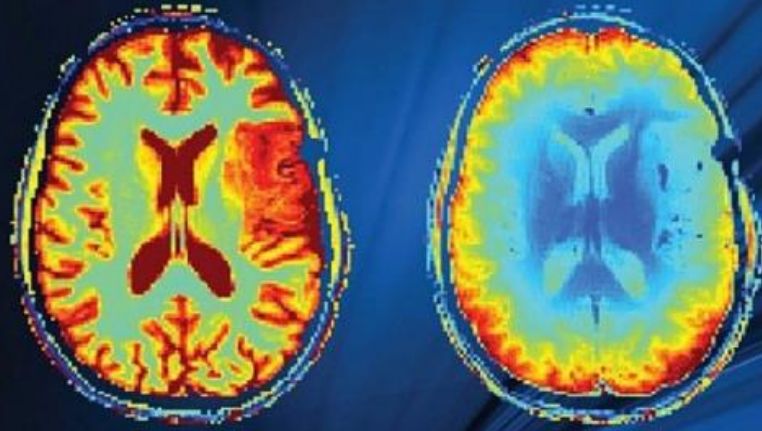

# *in vivo* NMR Spectroscopy

Principles and Techniques

Robin A. de Graaf

WILEY

vii

## Contents

Preface xv  
Abbreviations xvii  
Supplementary Material xxiv

<b>1</b>	<b>Basic Principles</b>	<b>1</b>
1.1	Introduction	1
1.2	Classical Magnetic Moments	3
1.3	Nuclear Magnetization	5
1.4	Nuclear Induction	9
1.5	Rotating Frame of Reference	11
1.6	Transverse $T_2$ and $T_2^*$ Relaxation	12
1.7	Bloch Equations	16
1.8	Fourier Transform NMR	17
1.9	Chemical Shift	20
1.10	Digital NMR	23
1.10.1	Analog-to-digital Conversion	23
1.10.2	Signal Averaging	25
1.10.3	Digital Fourier Transformation	25
1.10.4	Zero Filling	25
1.10.5	Apodization	26
1.11	Quantum Description of NMR	28
1.12	Scalar Coupling	30
1.13	Chemical and Magnetic Equivalence	33
	Exercises	37
	References	40
<b>2</b>	<b><i>In Vivo</i> NMR Spectroscopy – Static Aspects</b>	<b>43</b>
2.1	Introduction	43
2.2	Proton NMR Spectroscopy	43
2.2.1	Acetate (Ace)	51
2.2.2	<i>N</i> -Acetyl Aspartate (NAA)	52
2.2.3	<i>N</i> -Acetyl Aspartyl Glutamate (NAAG)	53
2.2.4	Adenosine Triphosphate (ATP)	54
2.2.5	Alanine (Ala)	55
2.2.6	$\gamma$ -Aminobutyric Acid (GABA)	56
2.2.7	Ascorbic Acid (Asc)	57
2.2.8	Aspartic Acid (Asp)	58

x Contents

4.6	Spatial Frequency Space	221
4.7	Fast MRI Sequences	225
4.7.1	Reduced TR Methods	225
4.7.2	Rapid <i>k</i> -Space Traversal	226
4.7.3	Parallel MRI	229
4.7.3.1	SENSE	230
4.7.3.2	GRAPPA	233
4.8	Contrast in MRI	234
4.8.1	$T_1$ and $T_2$ Relaxation Mapping	236
4.8.2	Magnetic Field $B_0$ Mapping	239
4.8.3	Magnetic Field $B_1$ Mapping	241
4.8.4	Alternative Image Contrast Mechanisms	242
4.8.5	Functional MRI	243
	Exercises	245
	References	249
<b>5</b>	<b>Radiofrequency Pulses</b>	<b>253</b>
5.1	Introduction	253
5.2	Square RF Pulses	253
5.3	Selective RF Pulses	259
5.3.1	Fourier-transform-based RF Pulses	260
5.3.2	RF Pulse Characteristics	262
5.3.3	Optimized RF Pulses	266
5.3.4	Multifrequency RF Pulses	269
5.4	Composite RF Pulses	271
5.5	Adiabatic RF Pulses	273
5.5.1	Rotating Frame of Reference	275
5.5.2	Adiabatic Condition	276
5.5.3	Modulation Functions	278
5.5.4	AFP Refocusing	280
5.5.5	Adiabatic Plane Rotation of Arbitrary Nutation Angle	282
5.6	Multidimensional RF Pulses	284
5.7	Spectral–Spatial RF Pulses	284
	Exercises	286
	References	288
<b>6</b>	<b>Single Volume Localization and Water Suppression</b>	<b>293</b>
6.1	Introduction	293
6.2	Single-volume Localization	294
6.2.1	Image Selected <i>In Vivo</i> Spectroscopy (ISIS)	295
6.2.2	Chemical Shift Displacement	297
6.2.3	Coherence Selection	301
6.2.3.1	Phase Cycling	302
6.2.3.2	Magnetic Field Gradients	302
6.2.4	STimulated Echo Acquisition Mode (STEAM)	304
6.2.5	Point Resolved Spectroscopy (PRESS)	307
6.2.6	Signal Dephasing with Magnetic Field Gradients	309
6.2.7	Localization by Adiabatic Selective Refocusing (LASER)	314
6.3	Water Suppression	317
6.3.1	Binomial and Related Pulse Sequences	318

6.3.2	Frequency-Selective Excitation	321
6.3.3	Frequency-Selective Refocusing	323
6.3.4	Relaxation-Based Methods	323
6.3.5	Non-water-suppressed NMR Spectroscopy	326
	Exercises	327
	References	330
<b>7</b>	<b>Spectroscopic Imaging and Multivolume Localization</b>	<b>335</b>
7.1	Introduction	335
7.2	Principles of MRSI	335
7.3	$k$ -Space Description of MRSI	338
7.4	Spatial Resolution in MRSI	339
7.5	Temporal Resolution in MRSI	341
7.5.1	Conventional Methods	343
7.5.1.1	Circular and Spherical $k$ -Space Sampling	343
7.5.1.2	$k$ -Space Apodization During Acquisition	343
7.5.1.3	Zoom MRSI	345
7.5.2	Methods Based on Fast MRI	346
7.5.2.1	Echo-planar Spectroscopic Imaging (EPSI)	346
7.5.2.2	Spiral MRSI	349
7.5.2.3	Parallel MRSI	350
7.5.3	Methods Based on Prior Knowledge	351
7.6	Lipid Suppression	353
7.6.1	Relaxation-based Methods	353
7.6.2	Inner Volume Selection and Volume Prelocalization	355
7.6.3	Outer Volume Suppression (OVS)	357
7.7	MR Spectroscopic Image Processing and Display	360
7.8	Multivolume Localization	364
7.8.1	Hadamard Localization	365
7.8.2	Sequential Multivolume Localization	366
	Exercises	368
	References	370
<b>8</b>	<b>Spectral Editing and 2D NMR</b>	<b>375</b>
8.1	Introduction	375
8.2	Quantitative Descriptions of NMR	375
8.2.1	Density Matrix Formalism	376
8.2.2	Classical Vector Model	377
8.2.3	Correlated Vector Model	378
8.2.4	Product Operator Formalism	379
8.3	Scalar Evolution	380
8.4	$J$ -Difference Editing	384
8.4.1	Principle	384
8.4.2	Practical Considerations	385
8.4.3	GABA, 2HG, and Lactate	389
8.5	Multiple Quantum Coherence Editing	395
8.6	Spectral Editing Alternatives	400
8.7	Heteronuclear Spectral Editing	402
8.7.1	Proton-observed, Carbon-edited (POCE) MRS	402
8.7.2	Polarization Transfer – INEPT and DEPT	407



# MR Spectroscopic Imaging

- MRI- Basics and k-Space Encoding
- Single Voxel Spectroscopy
- Multi-voxel Spectroscopy/Spectroscopic Imaging
- *Acceleration Techniques*: Phase-encoding, parallel Imaging, Echo-planar Imaging, Concentric Rings, Radial Imaging and more
- Multi-dimensional MR Spectroscopic Imaging (2D spectral+3D spatial)
- Conclusions



# MRI Uses Three

# Magnetic Fields

Static High Field ( $B_0$ )  
Creates or polarizes signal  
1000 Gauss to 110,000 Gauss  
(Earth's field is 0.5 G)

Gradient Fields  
1-4 G/cm

Used to image: determine spatial position of MR signal

Radiofrequency Field ( $B_1$ )

Excites or perturbs signal into a measurable form  
On the order of 0.1 G but in resonance with MR signal

RF coils also measure MR signal  
Excited or perturbed signal returns to equilibrium  
Important contrast mechanism

Bore  
(55 – 60 cm)

Magnetic field ( $B_0$ )

Shim

( $B_0$  uniformity)

Gradients

Body RF  
(transmit/receive)

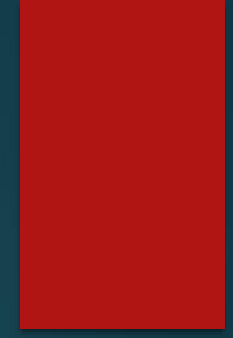
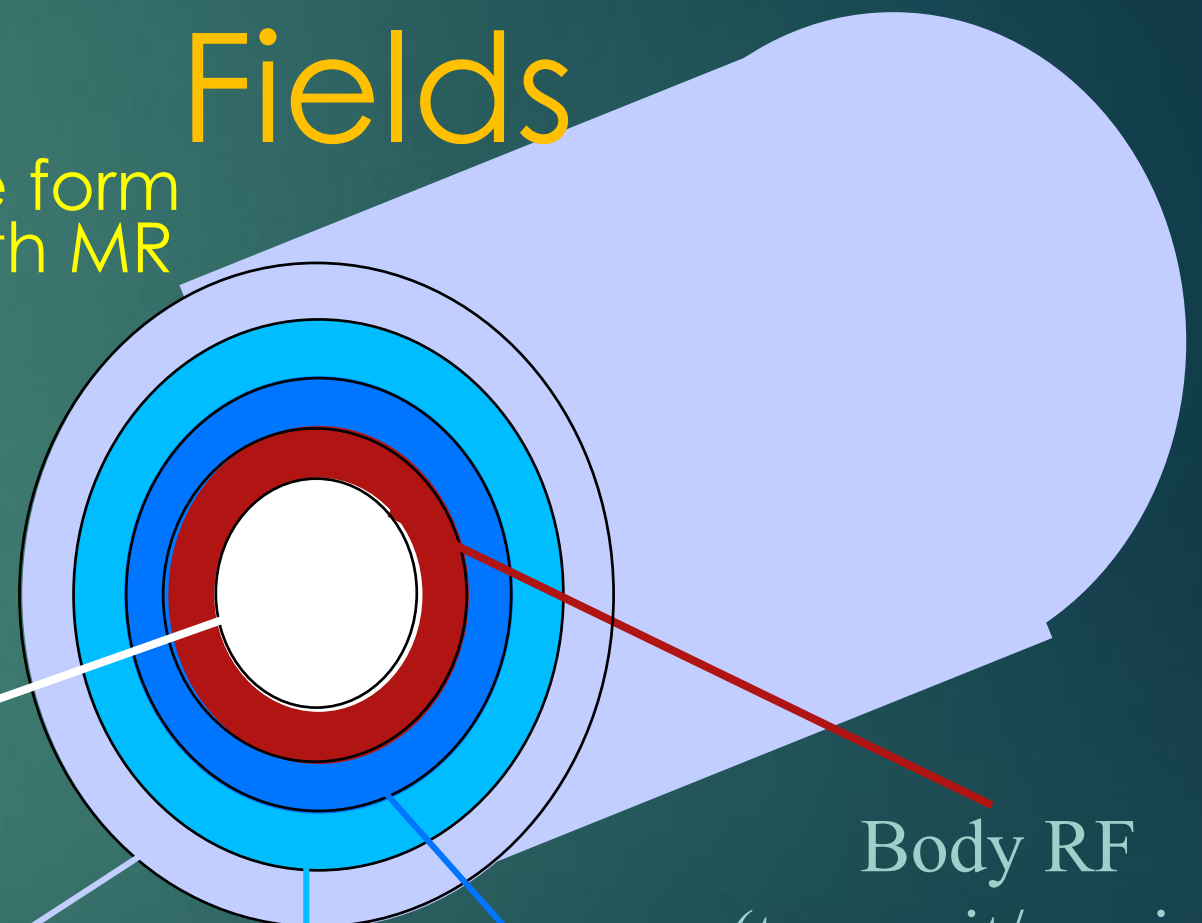

Lauterbur 1973  
KWE 1975

# Effect of pulsed field gradients (X, Y, Z)- Spatial Localization

Every imaging system will have three gradient coils that can modify the static field strength ( $B_0$ ) in X, Y, Z directions. Thus you have the control over changing the Larmor frequencies of nuclear spins in X, Y, Z directions

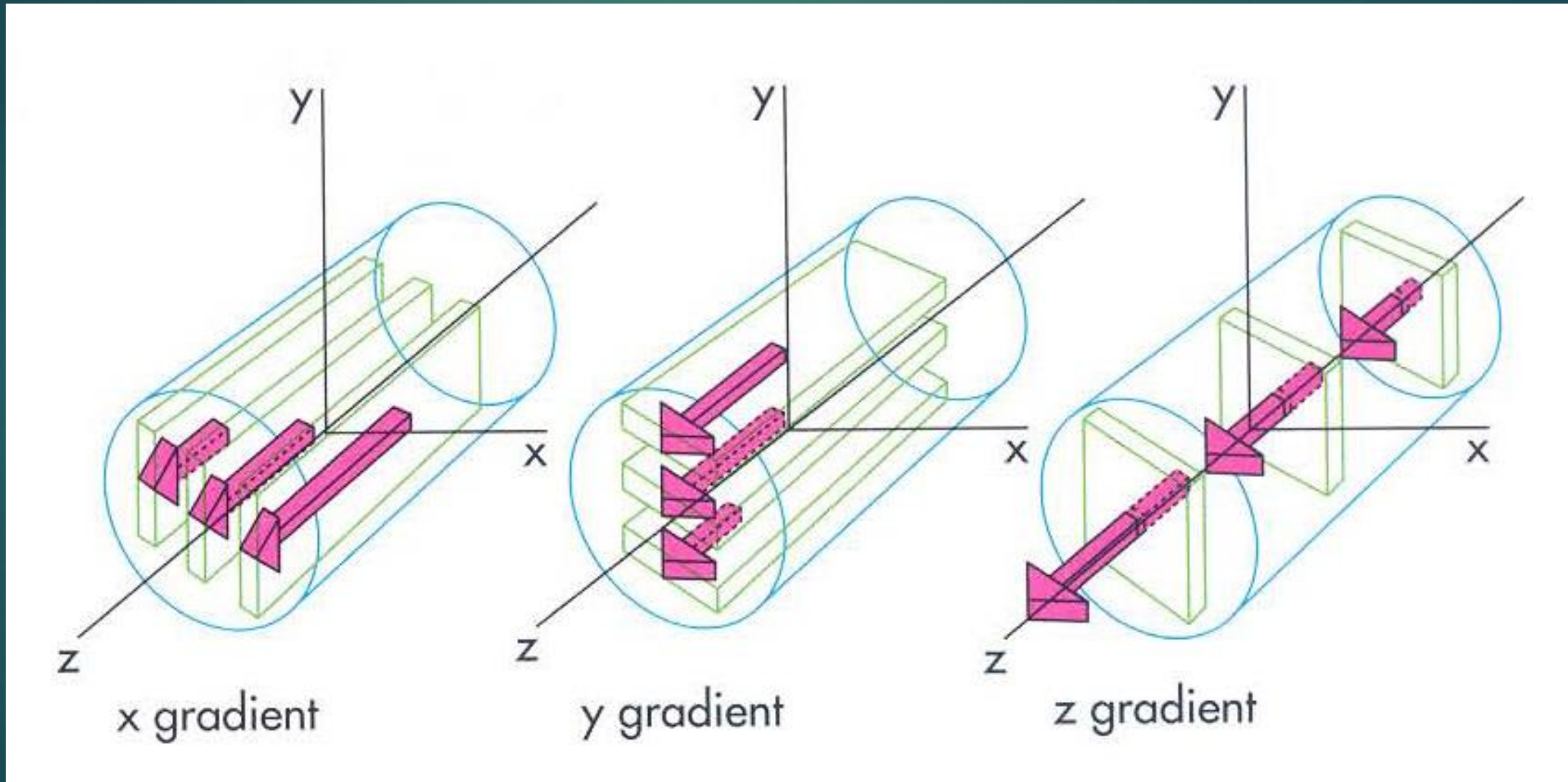

# Gradient Coils

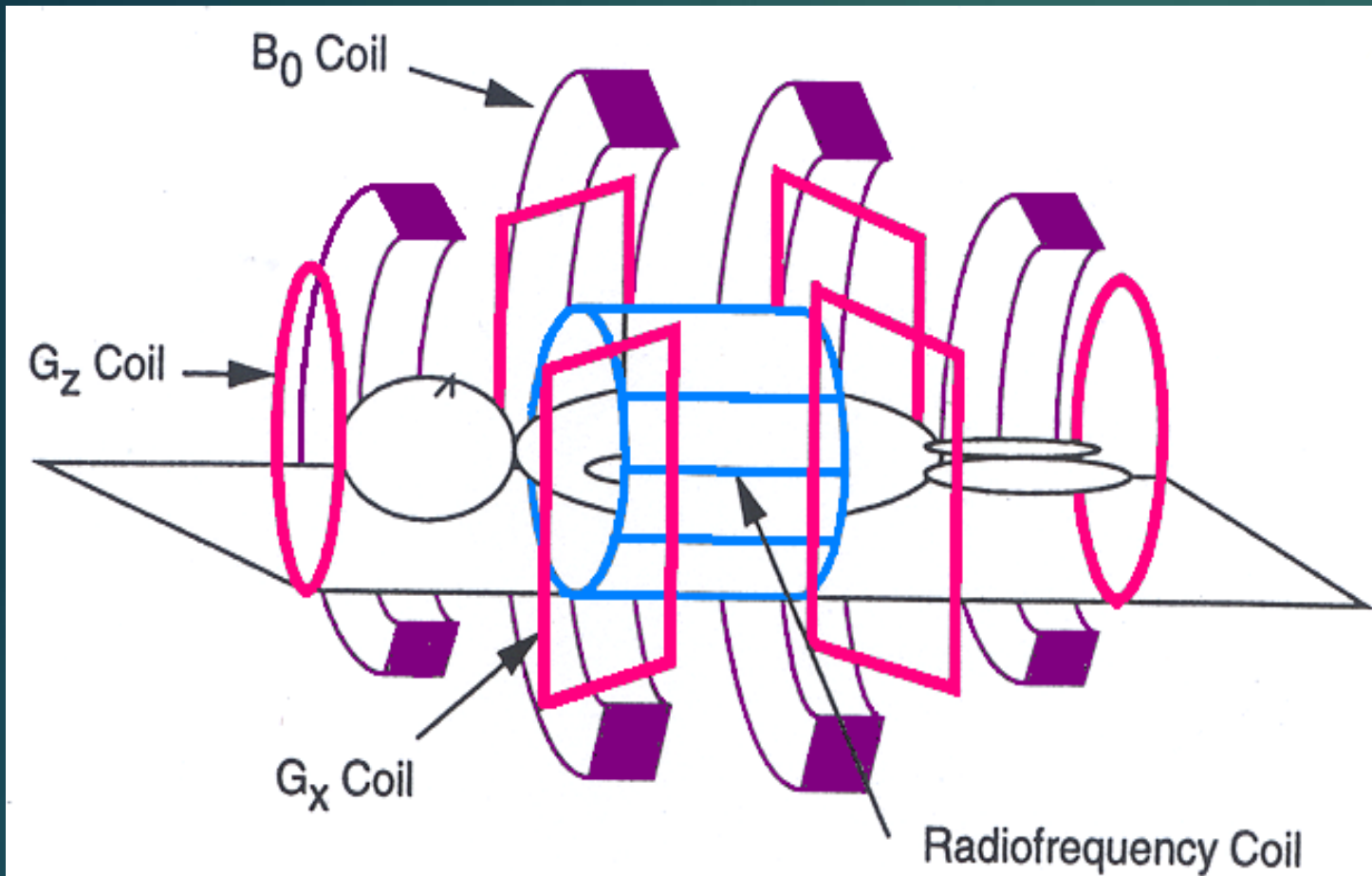

## Nishimura, MRI Principles

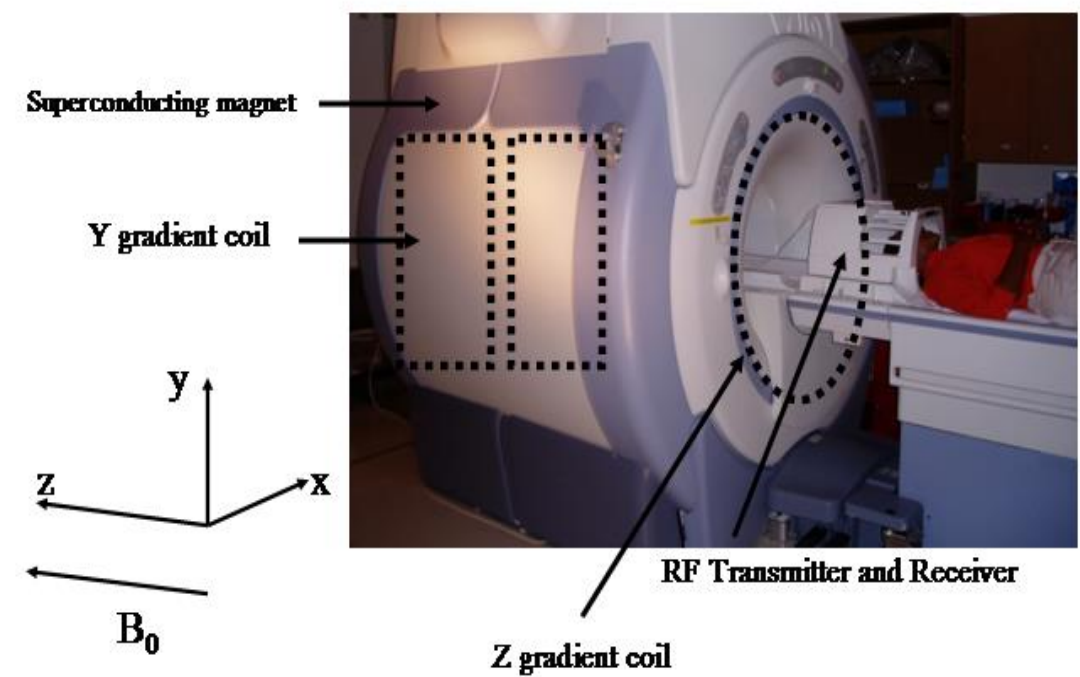



# Spatial Encoding/Slice Selection

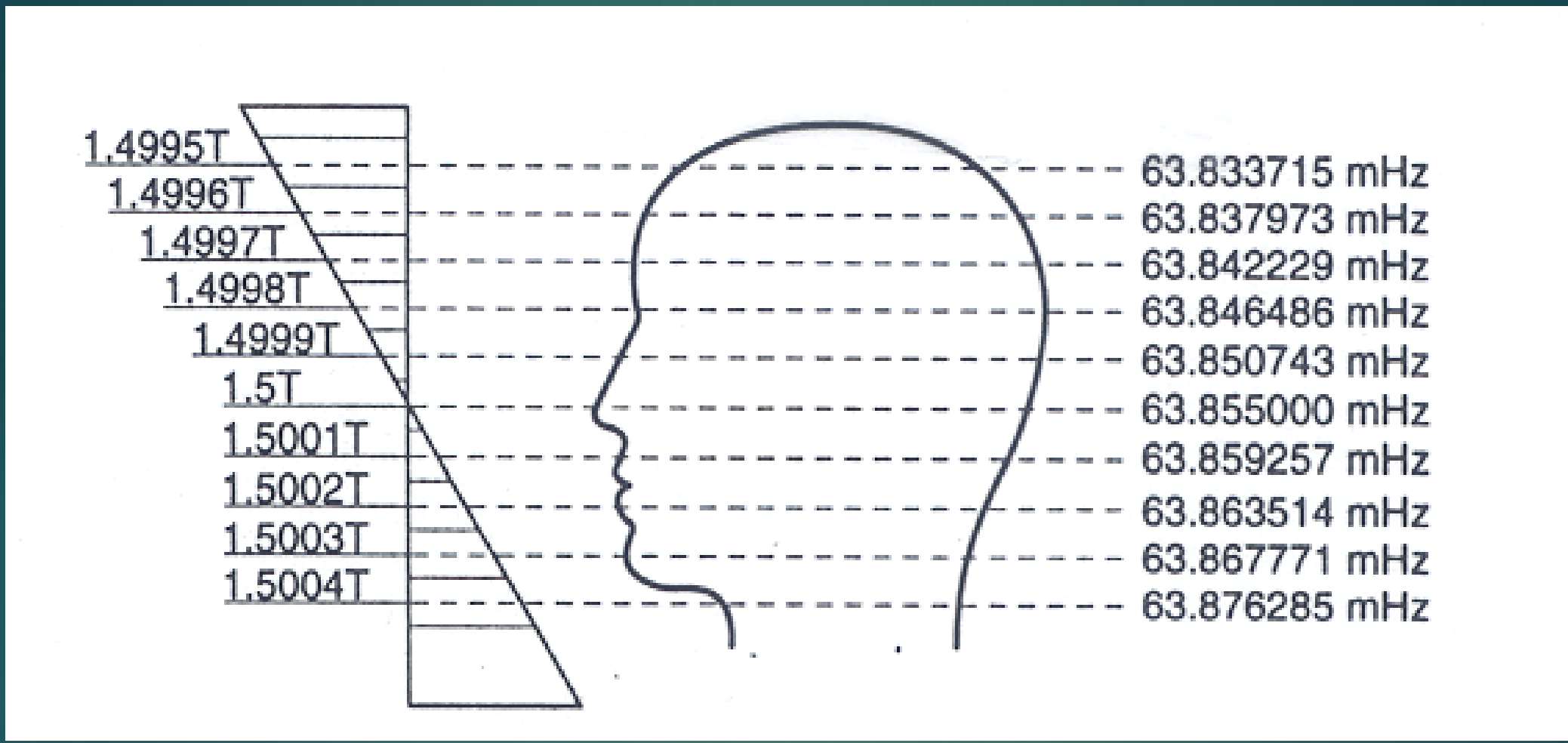

- ▶ The effects of the main magnetic field and the applied slice gradient. In this example, the local magnetic field changes in one-Gauss increments accompanied by a change in the precessional frequency from chin to the top of the head.

# k-Space Acquisition

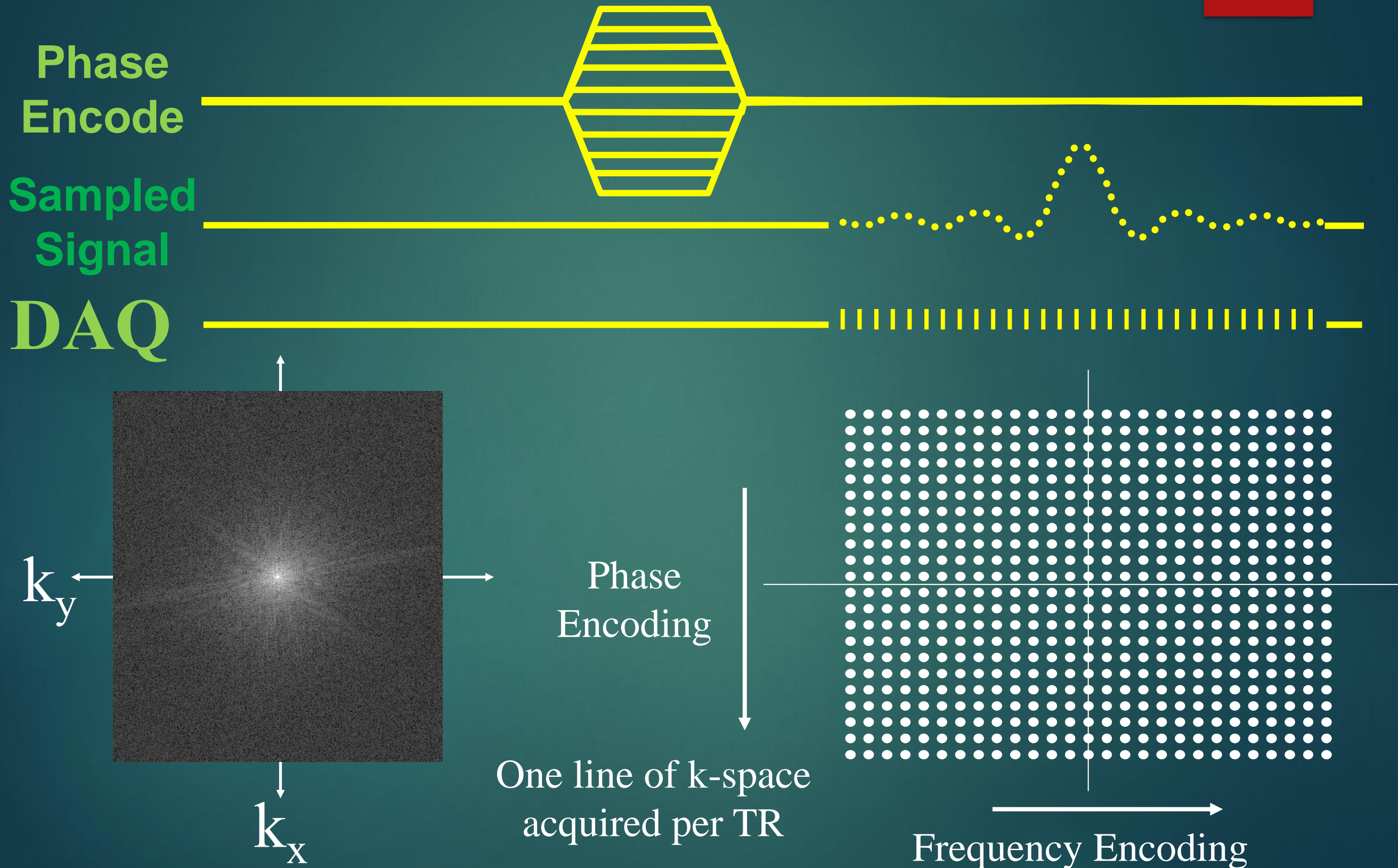

# Fourier Zeugmatography/Spin-Warp Imaging

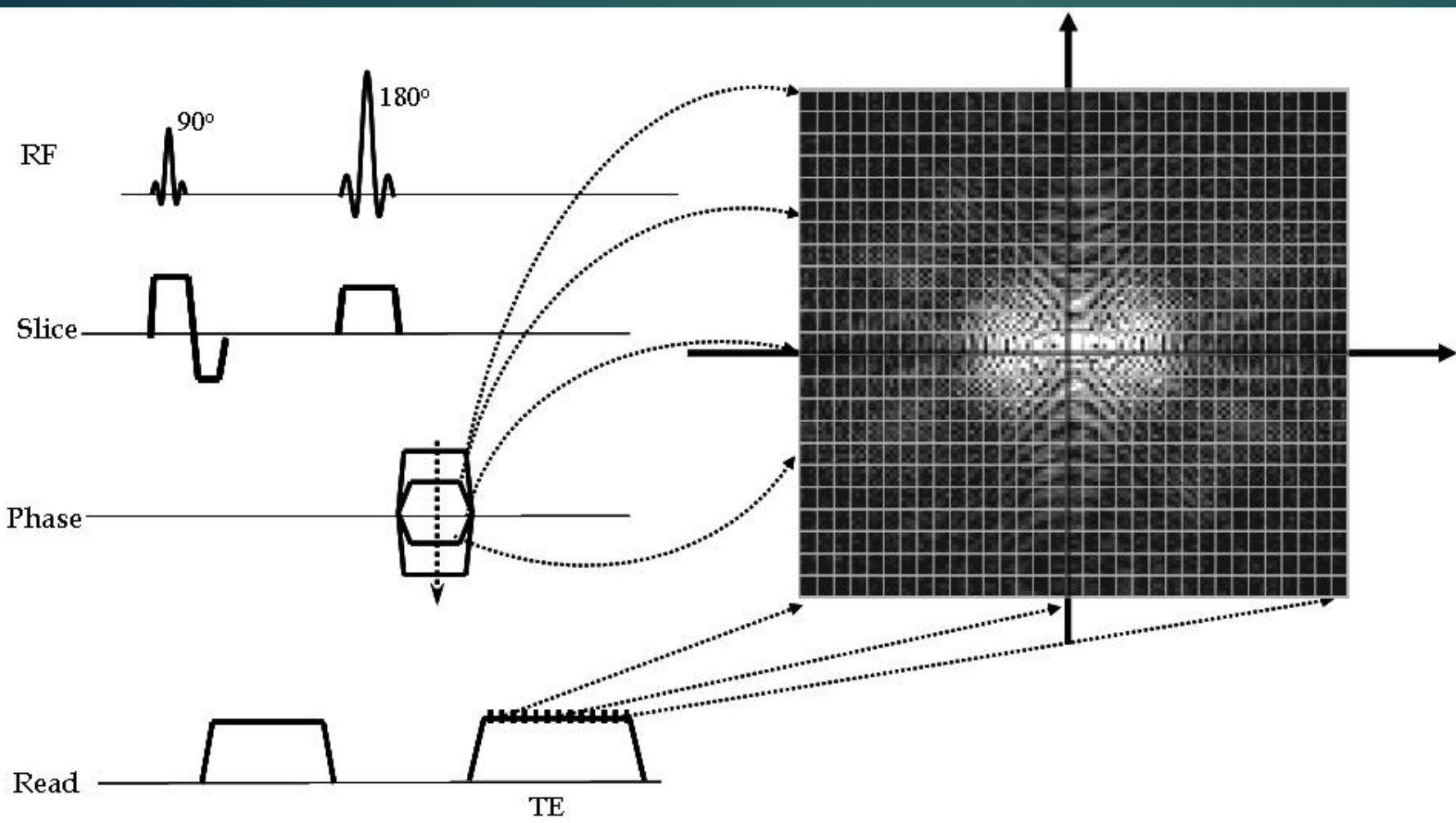

Gradient applied along the y-axis will cause the spins to precess at a frequency determined by their y position, and is called phase encoding. Next a gradient is applied along the x-axis and the spin-echo is collected. The frequency components of the echo gives information of the x-position and the phase values give information of the y-position.

$$S(t_x, t_y) = \iint \rho(x, y) \exp [i \gamma (G_x x t_x + G_y y t_y)] dx dy$$

$k_x = \gamma G_x t_x$  and  $k_y = \gamma G_y t_y$

$$S(k_x, k_y) = \iint \rho(x, y) \exp [i (k_x x + k_y y)] dx dy$$

$$\rho(x, y) = \iint S(k_x, k_y) \exp [-i (k_x x + k_y y)] dx dy$$

Kumar Welti Ernst JMR 18;69-83 1975;  
Edelstein et al. Spin Warp Imaging.  
PBM 1980



# K-Space

For a given data point in k-space, say  $(k_x, k_y)$ , its signal  $S(k_x, k_y)$  is the sum of all the little signal from each voxel  $I(x, y)$  in the physical space, under the gradient field at that particular moment

$$S(k_x, k_y) = \int \int I(x, y) e^{-i2\pi(k_x x + k_y y)} dx dy$$

From this equation, it can be seen that the acquired MR signal, which is also in a 2-D space (with  $k_x, k_y$  coordinates), is the Fourier Transform of the imaged object.

$$K_x = \gamma/2\pi \int_0^t G_x(t) dt$$

$$K_y = \gamma/2\pi \int_0^t G_y(t) dt$$

The frequency and phase encoding gradients control the imaging trajectory in k-space

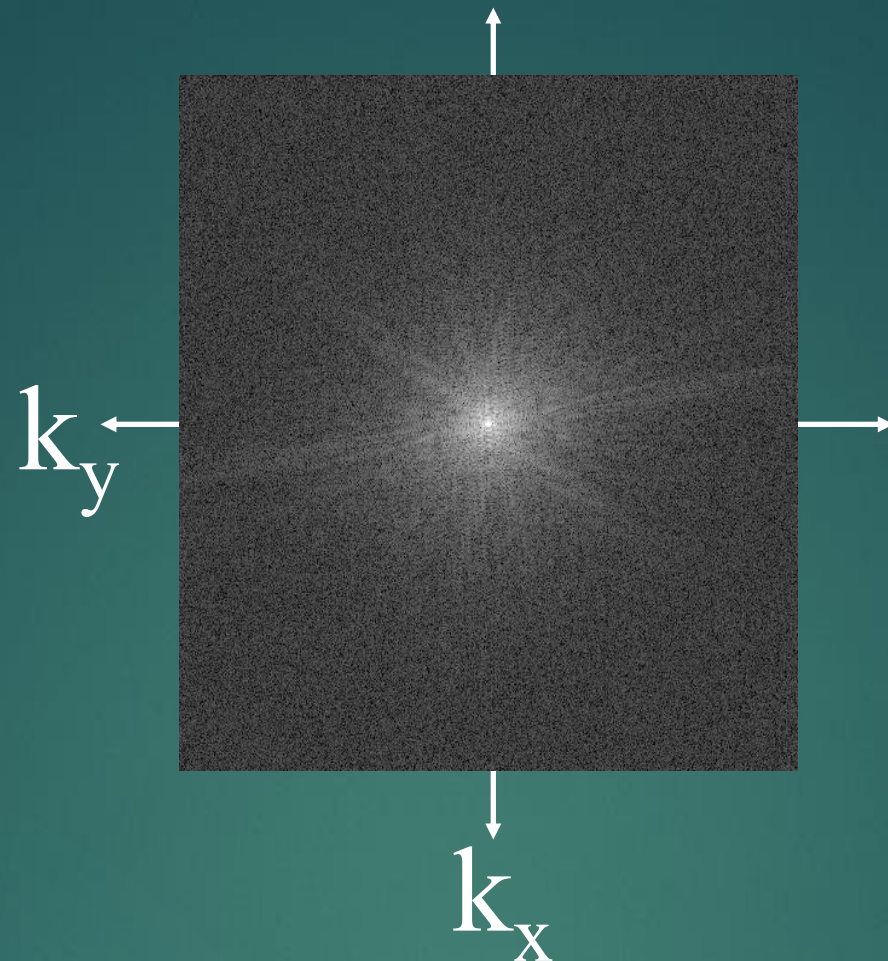

**MRI: Day one**

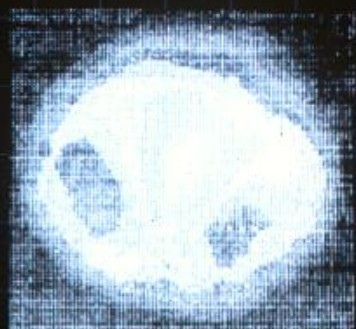

**Recent MRI of  
Calf muscle**

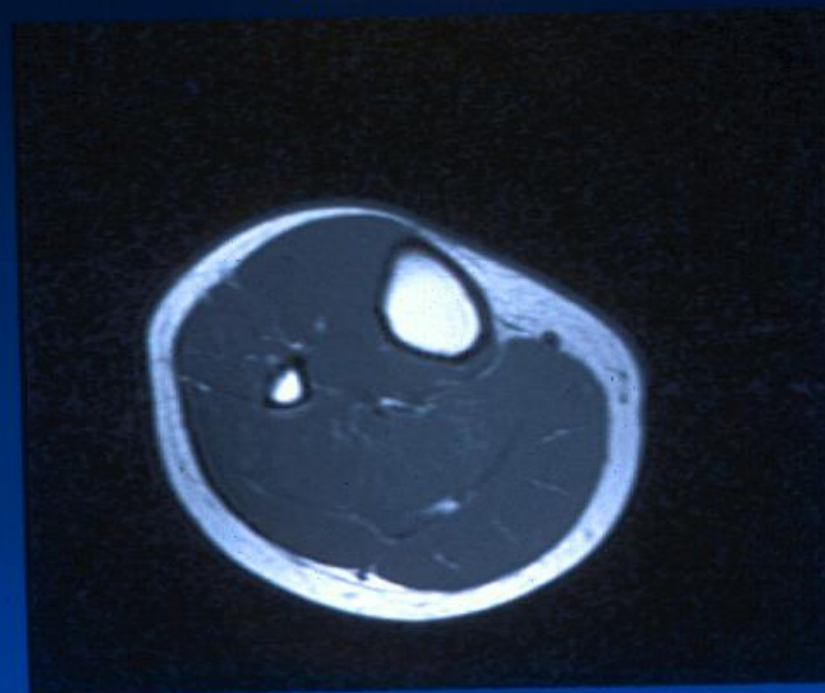



# Magnetic Resonance Imaging (MRI)



- MRI exploits Nuclear Magnetic Resonance (NMR) to produce water-based images
  - Signal from  $^1\text{H}$  in water
  - Gray scale caused by T1/T2 relaxation and  $^1\text{H}$  density within a voxel
- MRI resolution
  - 512x512 voxels in a slice
  - Sub-millimeter voxel volume
- Structural differences cause T1/T2 relaxation variation among voxels







# Problems with Anatomical Imaging

- ▶ Despite its superb soft tissue contrast and multiplanar capability, anatomical MRI is largely limited to depicting morphological abnormality.
- ▶ Anatomical MRI suffers from nonspecificity. Different disease processes can appear similar upon anatomic imaging, and in turn a single disease entity may have varied imaging findings.
- ▶ The underlying metabolic or functional integrity of brain cannot be adequately evaluated based on anatomical MRI alone.
- ▶ To that end, several physiology-based MRI methods have been developed to improve tumor characterization.
- Diffusion Weighted (DW) MRI/Diffusion Tensor Imaging (DTI): In addition to early diagnosis of cerebral ischemia, DW MRI is extremely sensitive in detecting other intracranial disease processes, including cerebral abscess, traumatic shearing injury, etc.
- Perfusion Imaging: Dynamic susceptibility-weighted contrast-enhanced (DSC) perfusion MRI of the brain provides hemodynamic information.
- ▶ MR Spectroscopy for biochemical characterization, Improving Specificity of cancer and more

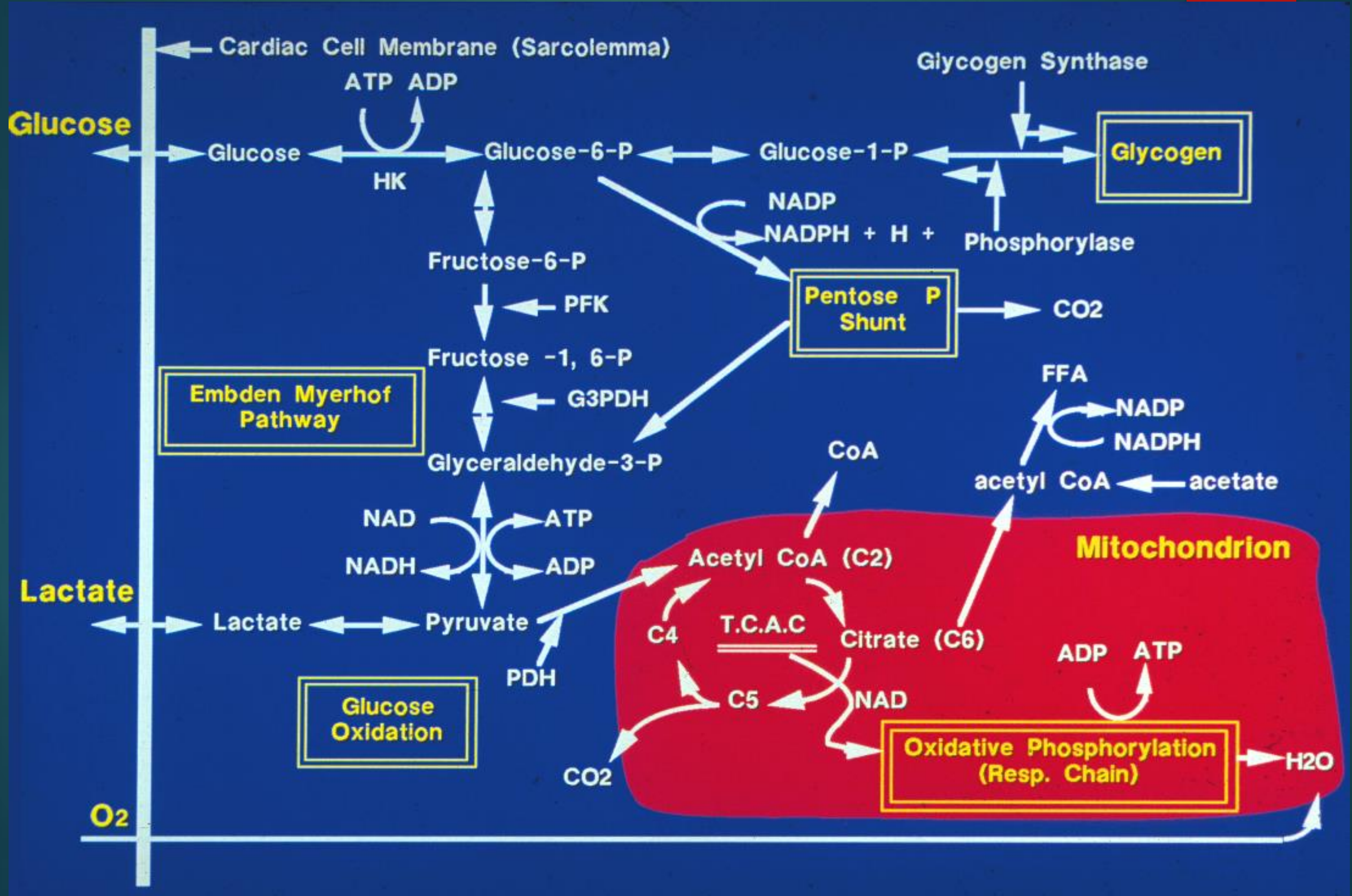





# Point Resolved Spectroscopy, PRESS

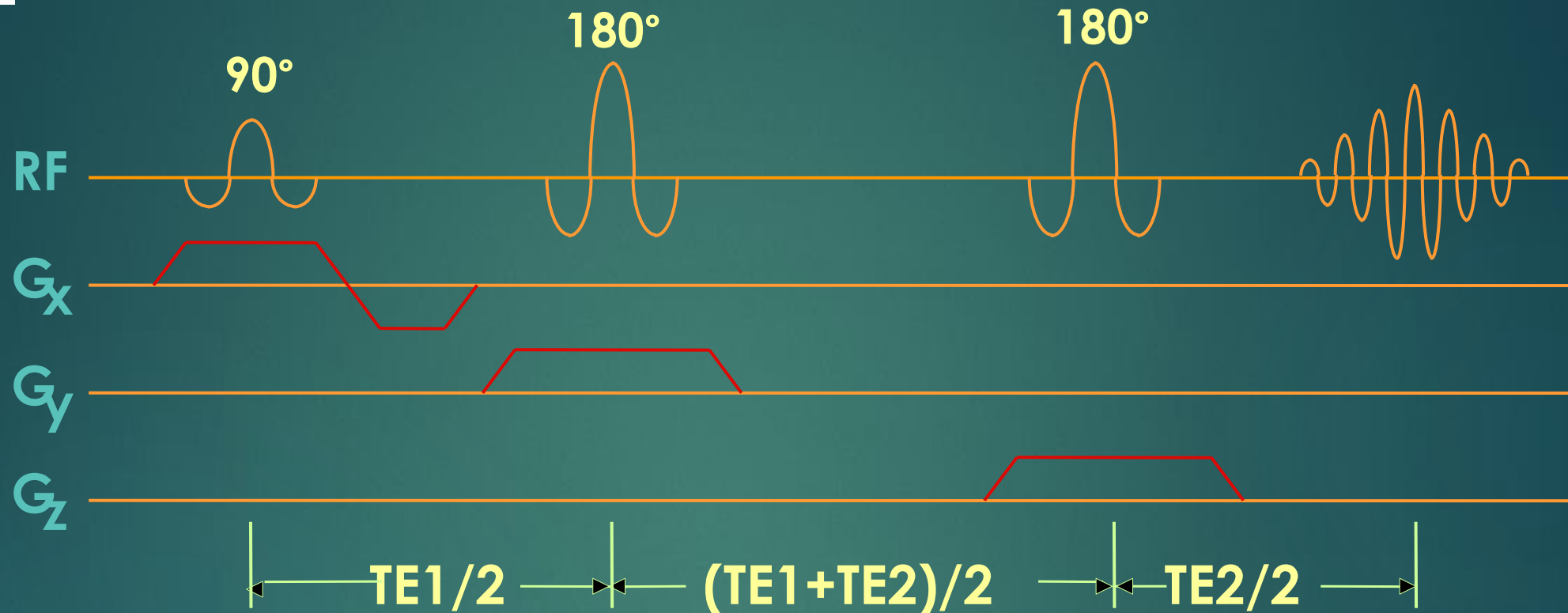

- A slice-selective 90° pulse is followed by two slice-selective 180° refocusing pulses
- Achieves localization within a single acquisition
  - Suitable for signals with long  $T_2$  –  $^1\text{H}$  MRS

Bottomley PA. Annal NY Acad Sci  
1987; 508: 333-348.

STEAM: Frahm MRM 1989



# Localization

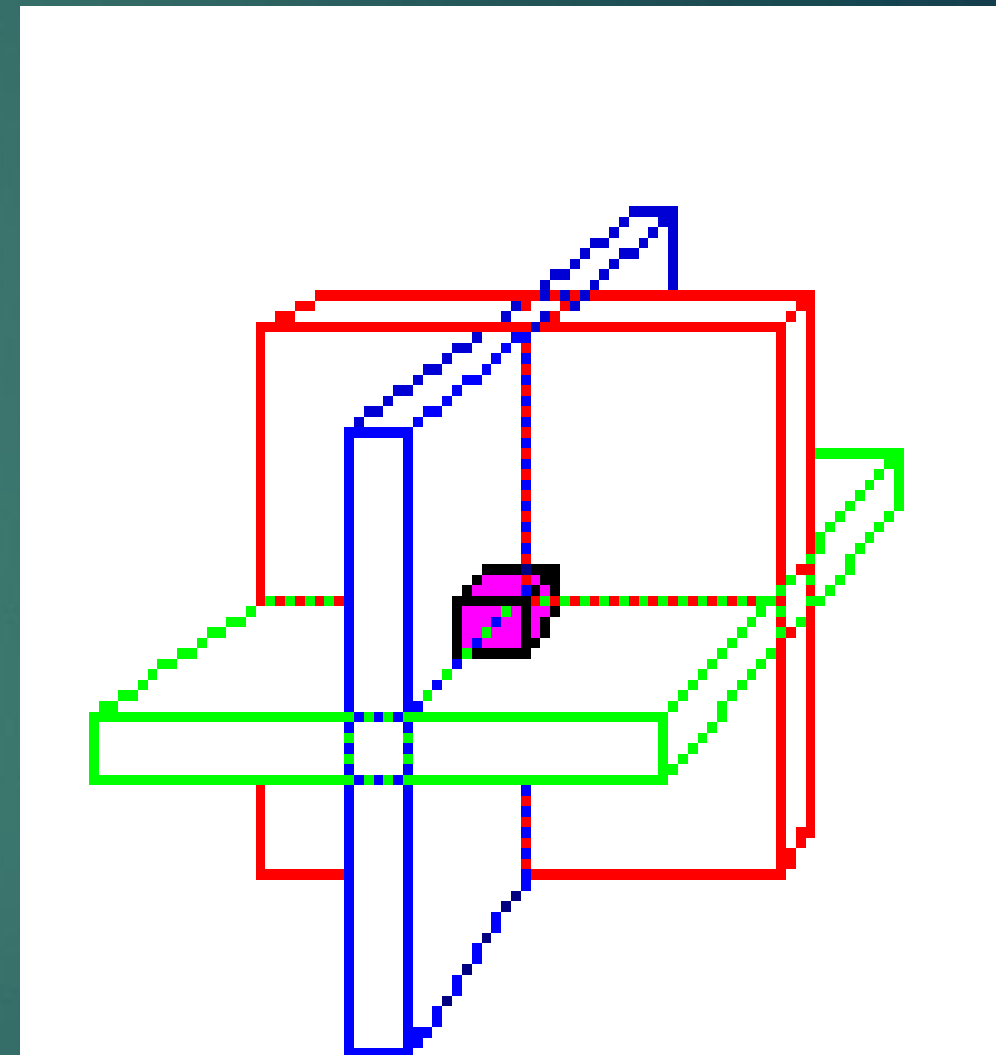
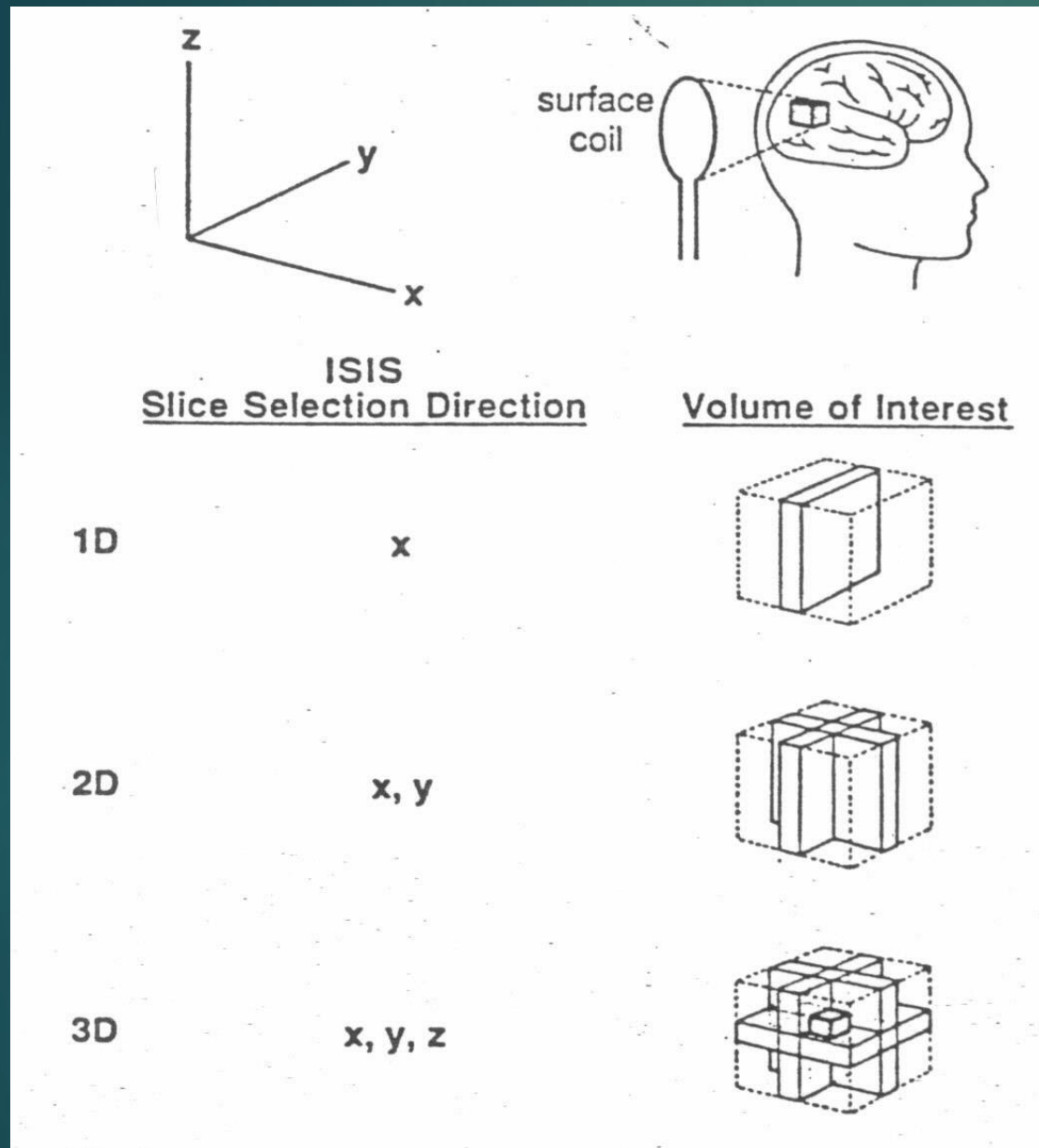

Frontal Gray

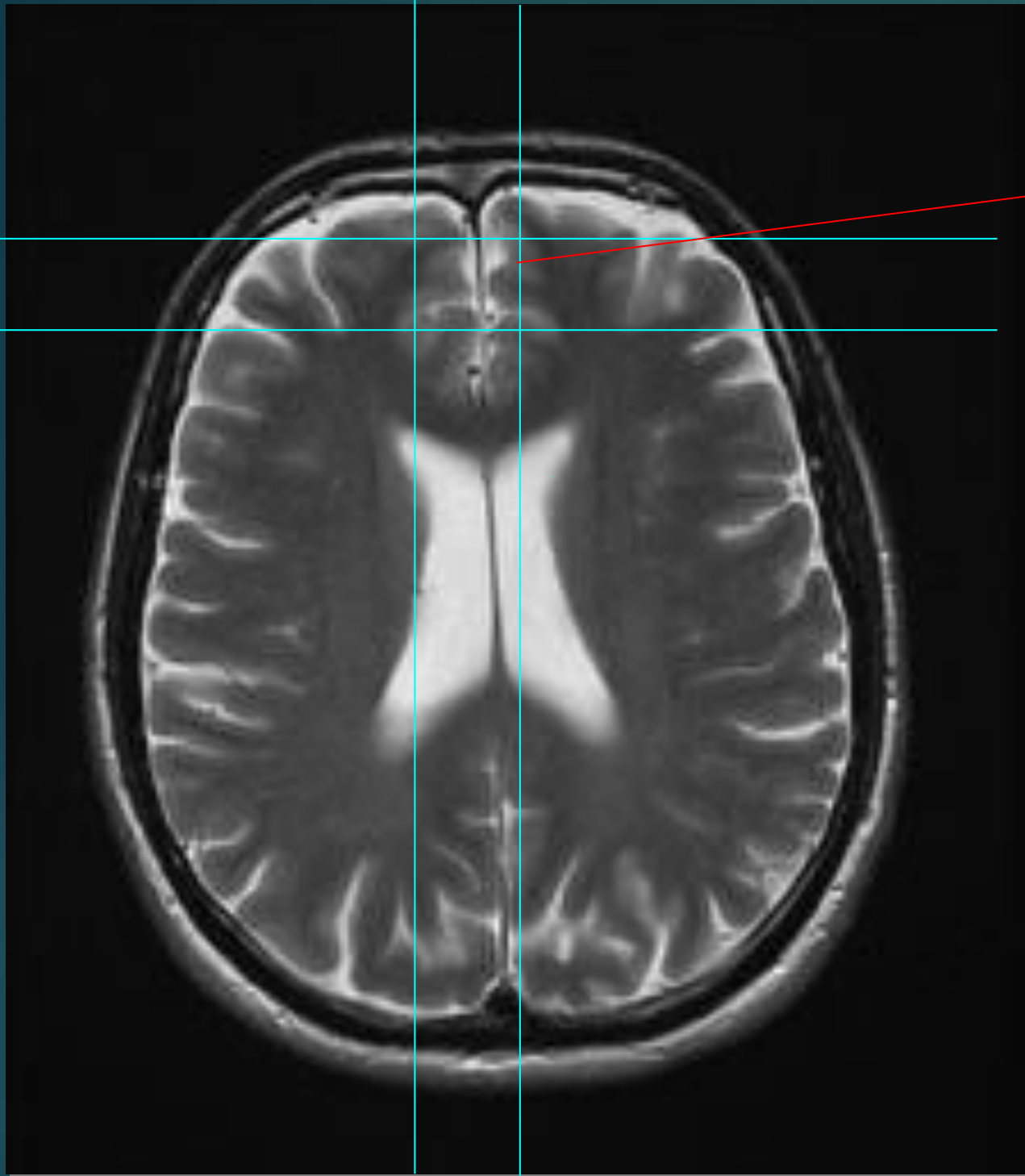

Occipital Gray

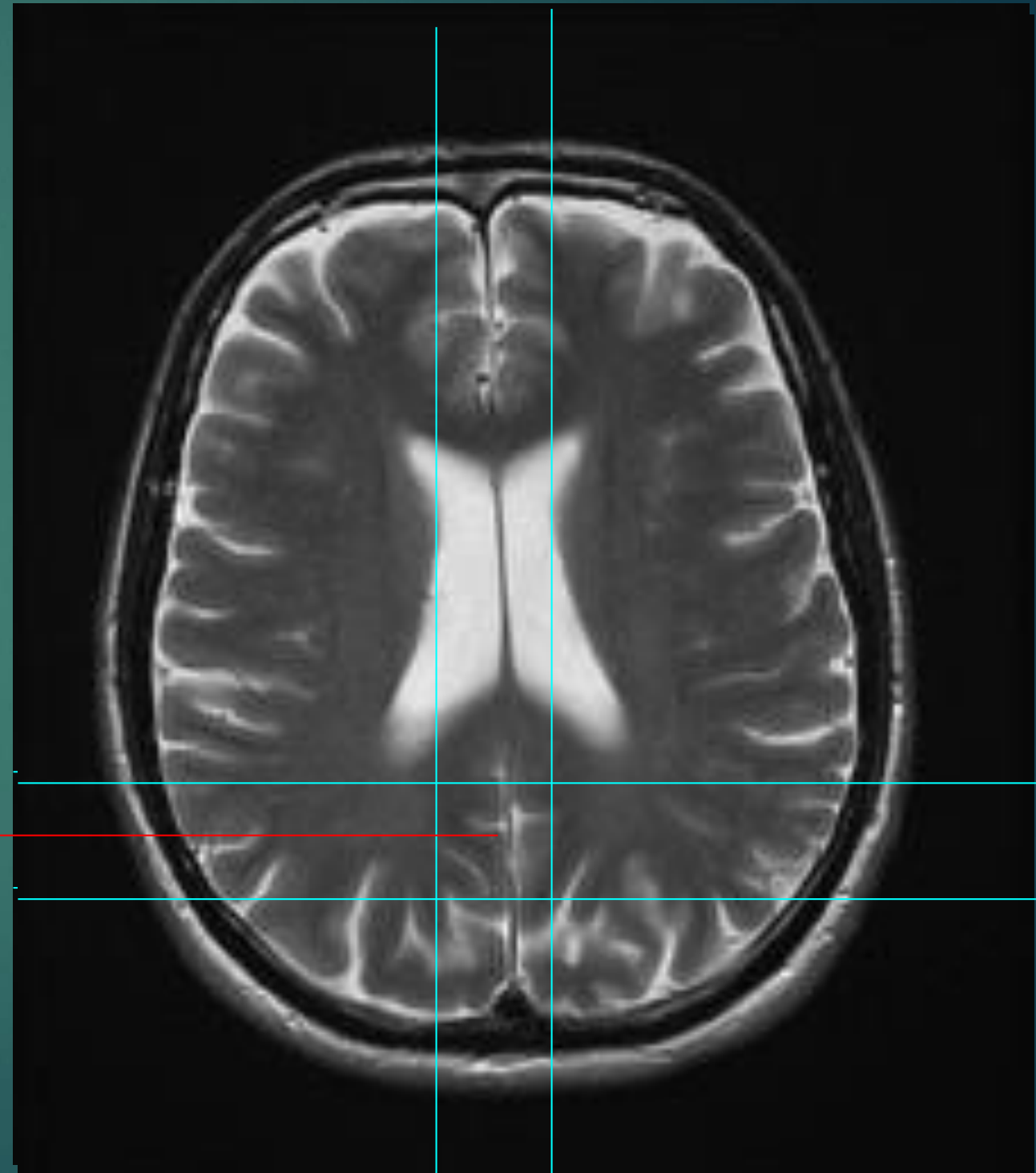

5-10 minutes for each voxel MRS  
Total duration =  $N \times 10$  minutes for  $N$   
voxels???

# Single Voxel Spectroscopy

## disadvantages

- requires large sample volume (2x2x2 cm<sup>3</sup> or more)
- requires many averages for adequate SNR
- limited coverage
- can only cover a small region in one experiment



# Multi-Voxel Spectroscopy

the problem of limited coverage can be fixed by taking conducting multiple experiments from different locations

this is problematic as the total experimental time will scale with the number of different voxels you wish to measure

# Spectral Characteristics from different zones in Healthy (<40 years) Volunteer

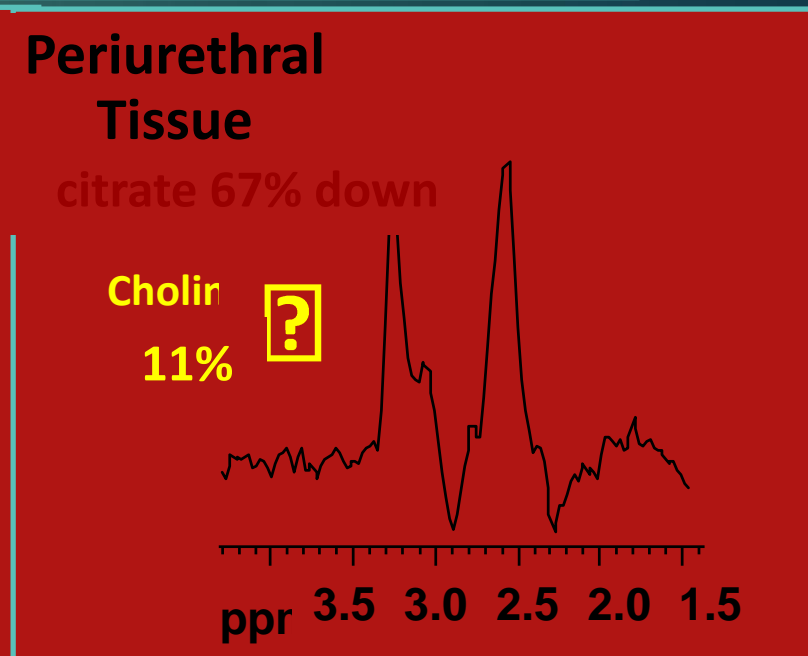
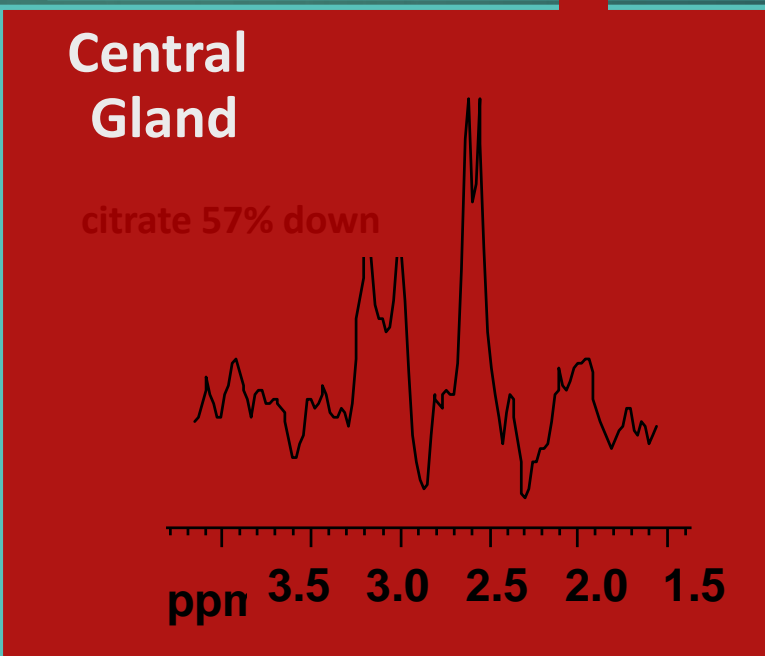
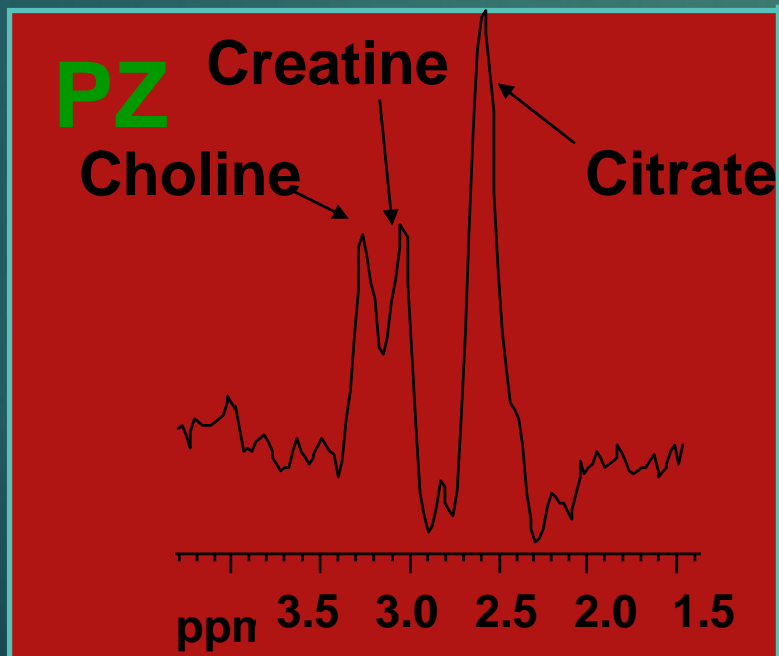
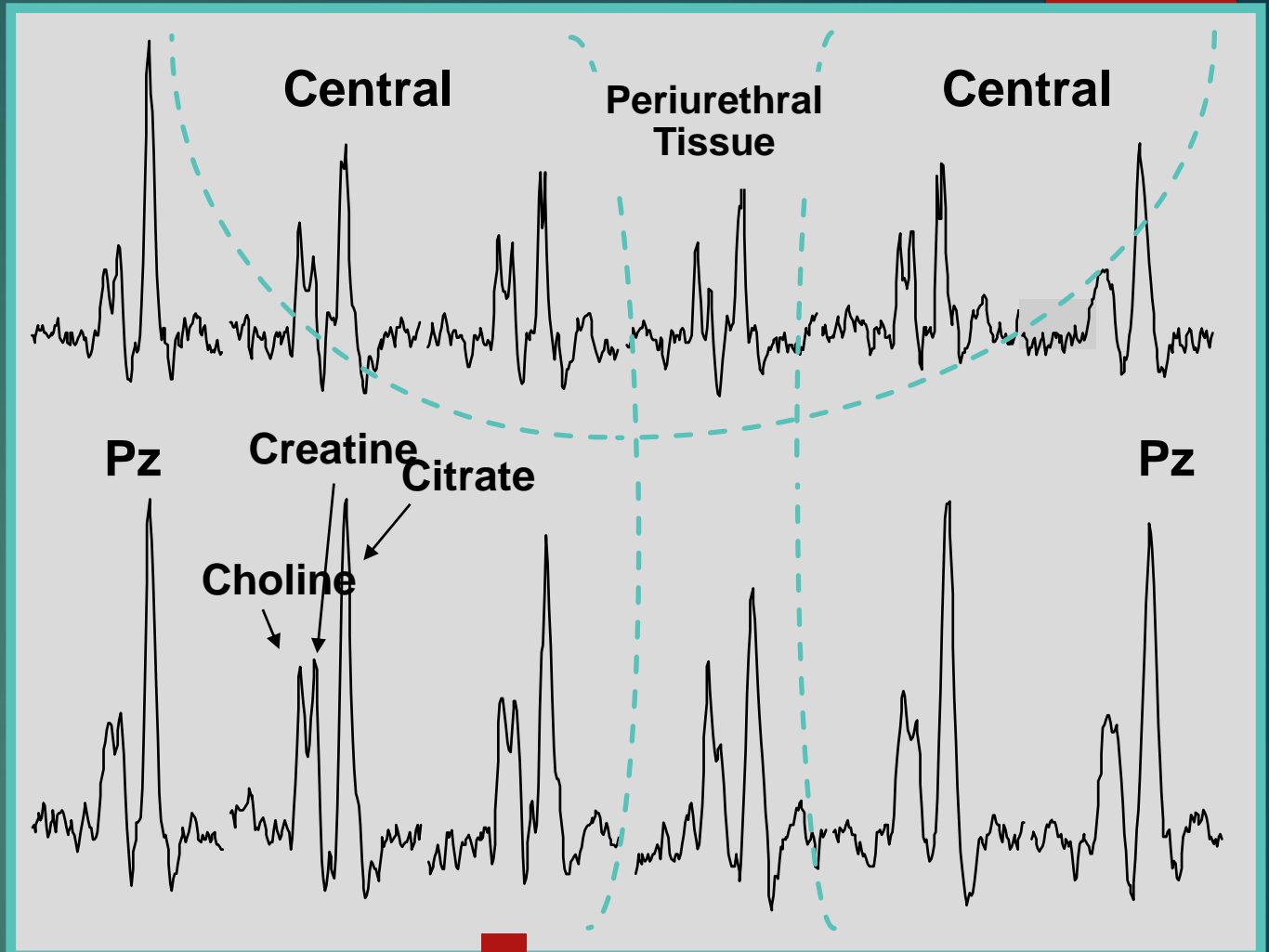
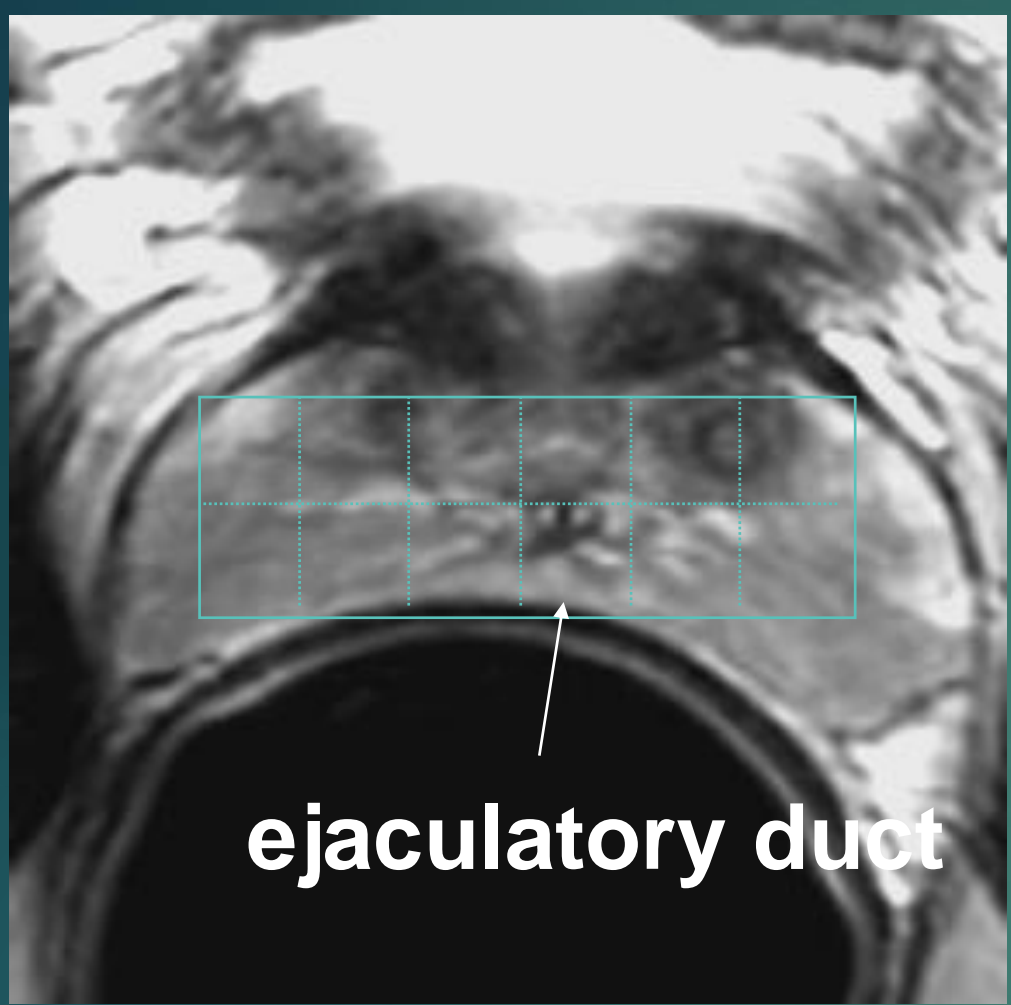

Three Distinctive Metabolic Patterns

## NMR chemical shift imaging in three dimensions

(*in vivo* biochemistry/<sup>31</sup>P imaging/metabolite mapping)

T. R. BROWN\*, B. M. KINCAID\*, AND K. UGURBIL†

\*Bell Laboratories, Murray Hill, New Jersey 07974; and †Department of Biochemistry, Columbia University, New York, New York 10032

*Communicated by John J. Hopfield, March 10, 1982*

**ABSTRACT** A method for obtaining the three-dimensional distribution of chemical shifts in a spatially inhomogeneous sample using Fourier transform NMR is presented. The method uses a sequence of pulsed field gradients to measure the Fourier transform of the desired distribution on a rectangular grid in  $(k, t)$  space. Simple Fourier inversion then recovers the original distribution. An estimated signal/noise ratio of 20 in 10 min is obtained for an “image” of the distribution of a 10 mM phosphorylated metabolite in the human head at a field of 20 kG with 2-cm resolution.

the resonant frequency of the spins) varying linear gradient,  $[\mathbf{G}(t) \cdot \mathbf{x}] \hat{z}$ , as shown in Fig. 1, how will this affect the FID? Under these conditions, the phase of each spin at time  $t$  after a rf pulse will depend on both  $\mathbf{x}$  and  $\delta$  as its instantaneous frequency is now given by  $\frac{d\phi}{dt} = \gamma H_T(t)$ , where  $\gamma$  is the gyromagnetic ratio for the species under observation and  $H_T(t) = [H_o + \mathbf{G}(t) \cdot \mathbf{x}](1 + \epsilon)$ . Here we have just augmented the externally applied field,  $H_o + \mathbf{G}(t) \cdot \mathbf{x}$ , by  $(1 + \epsilon)$  to take into account the electronic shield-



greater coverage can be obtained by  
spatially encoding time signals with phase-  
encoding gradients

phase-encoded data is encoded in k-space

this allows for more voxels to be collected  
in a single experiment as well as smaller  
voxels

# 1D Spatial Encoding

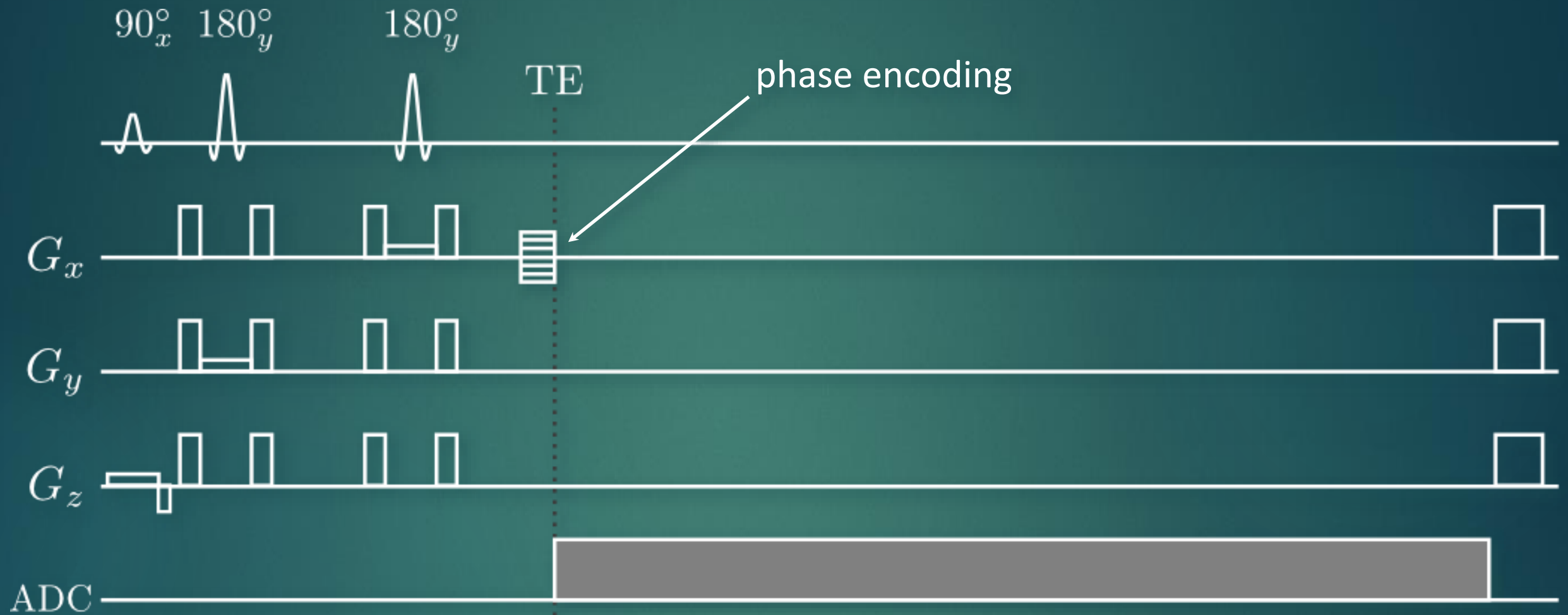

sample 1D spectroscopic imaging pulse sequence

each FID is phase encoded along one dimension

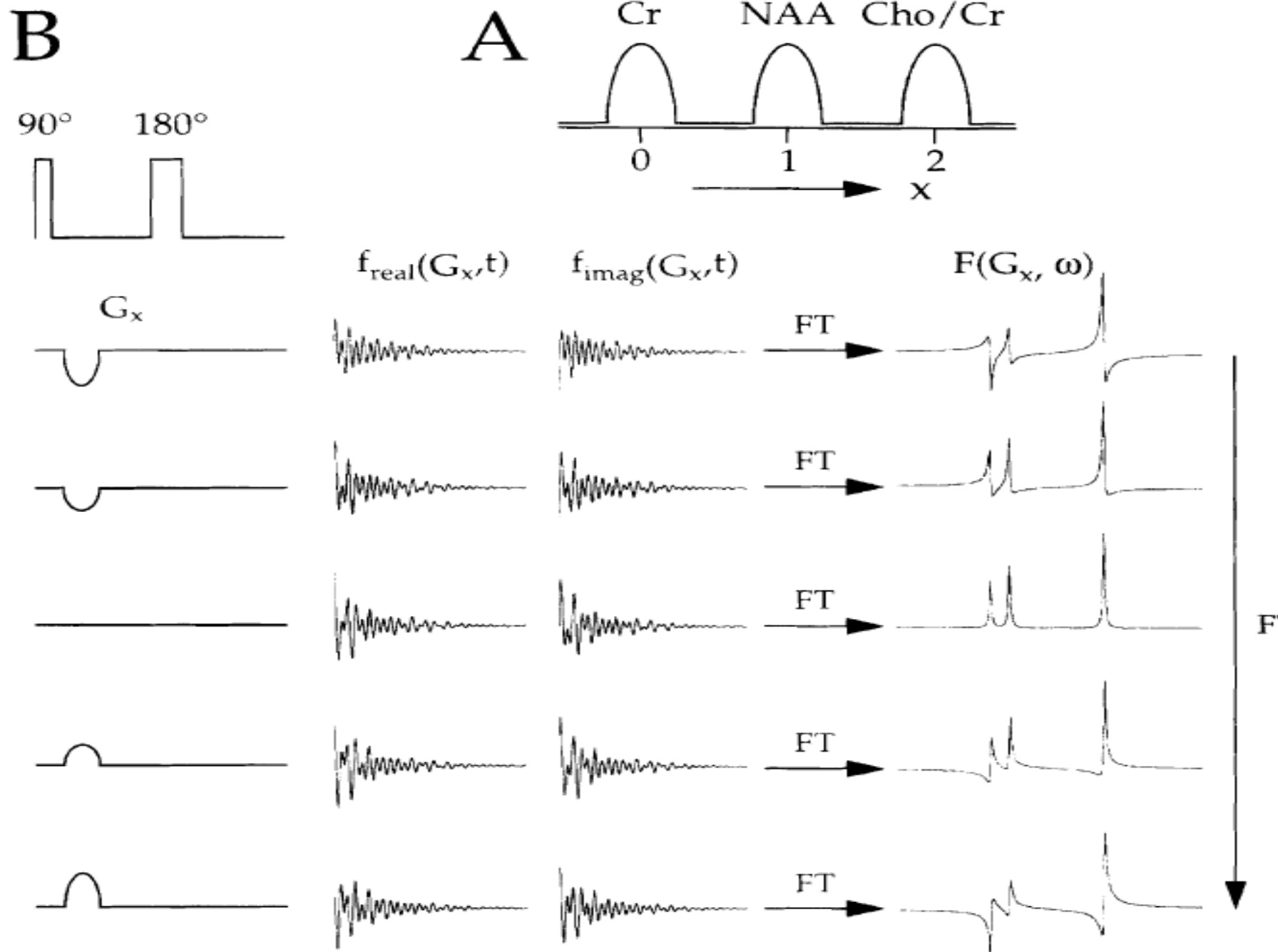

Resulting SI data set  
After FFT along  $x$  and  $t$   
we get

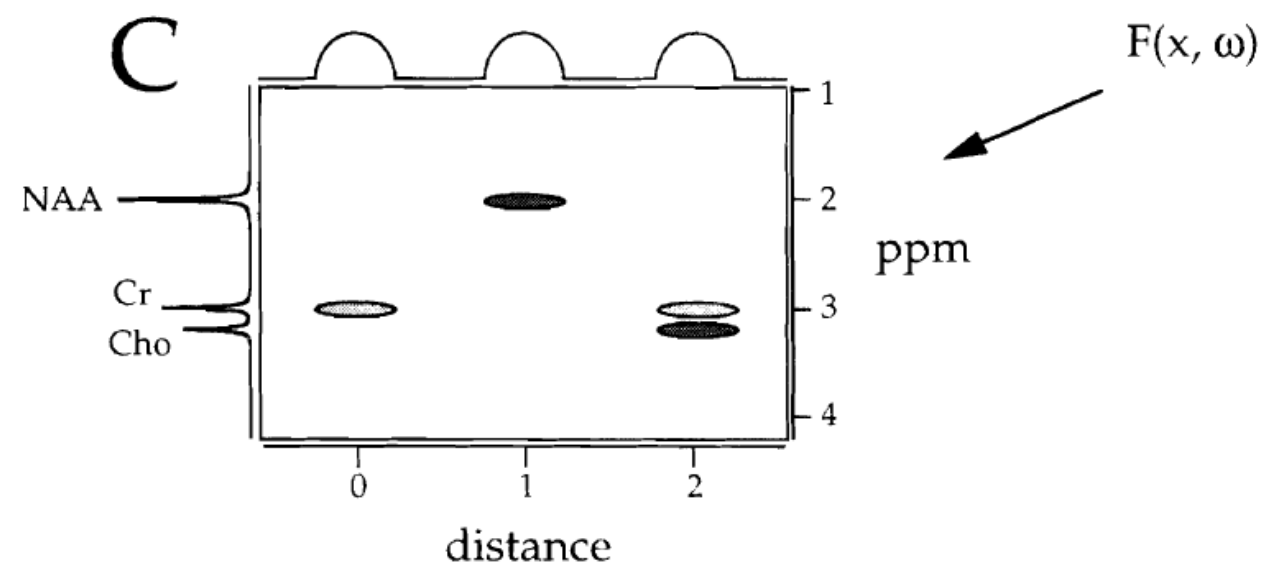



# 2D Spectroscopic Imaging

how do we fill out 2D k-t-space?



same as before except phase encoding happens  
in two different dimensions now

# Spatial Encoding

how do we use gradients to move  
around k-space?

$$\vec{k}(t) = \frac{\gamma}{2\pi} \int_0^t \vec{G}(\tau) d\tau$$

we can move anywhere in k-space so long as  
we program our gradients correctly

# 2D Spatial Encoding

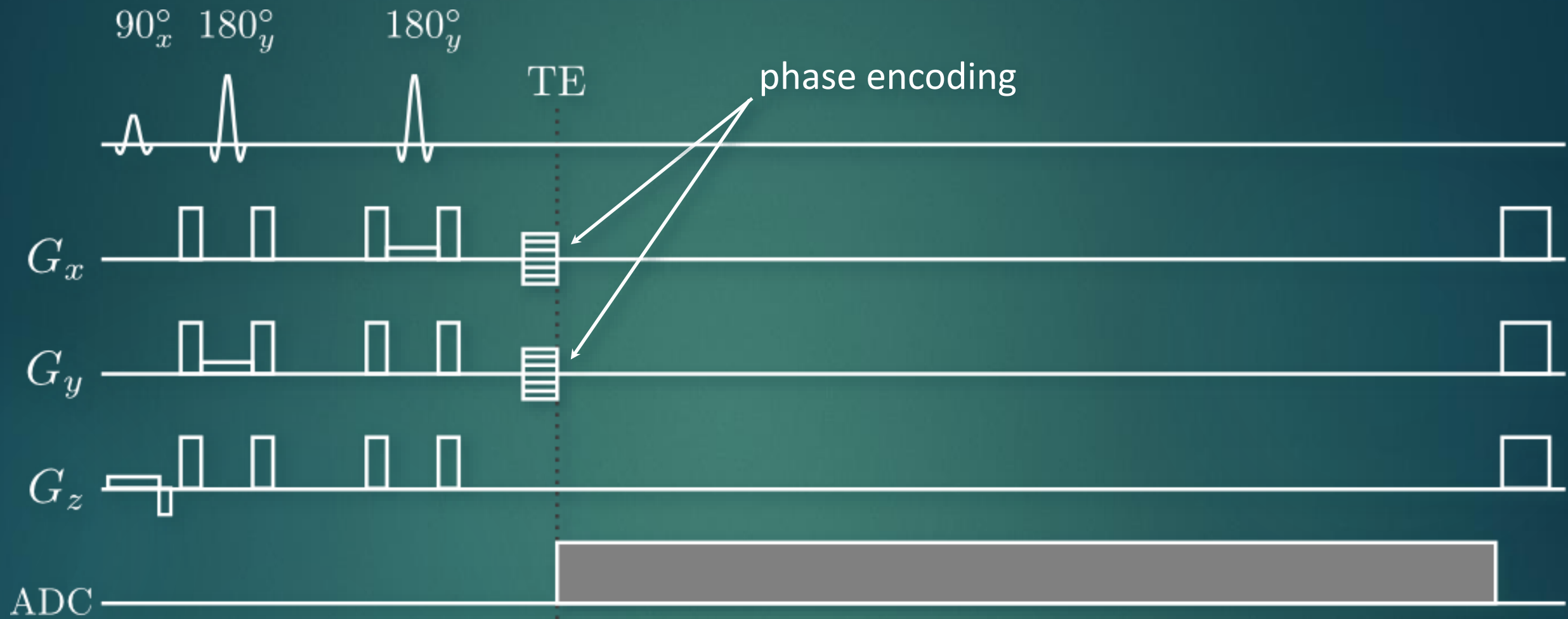

sample 2D spectroscopic imaging pulse sequence

each FID is phase encoded along one dimension



# 3D Spatial Encoding

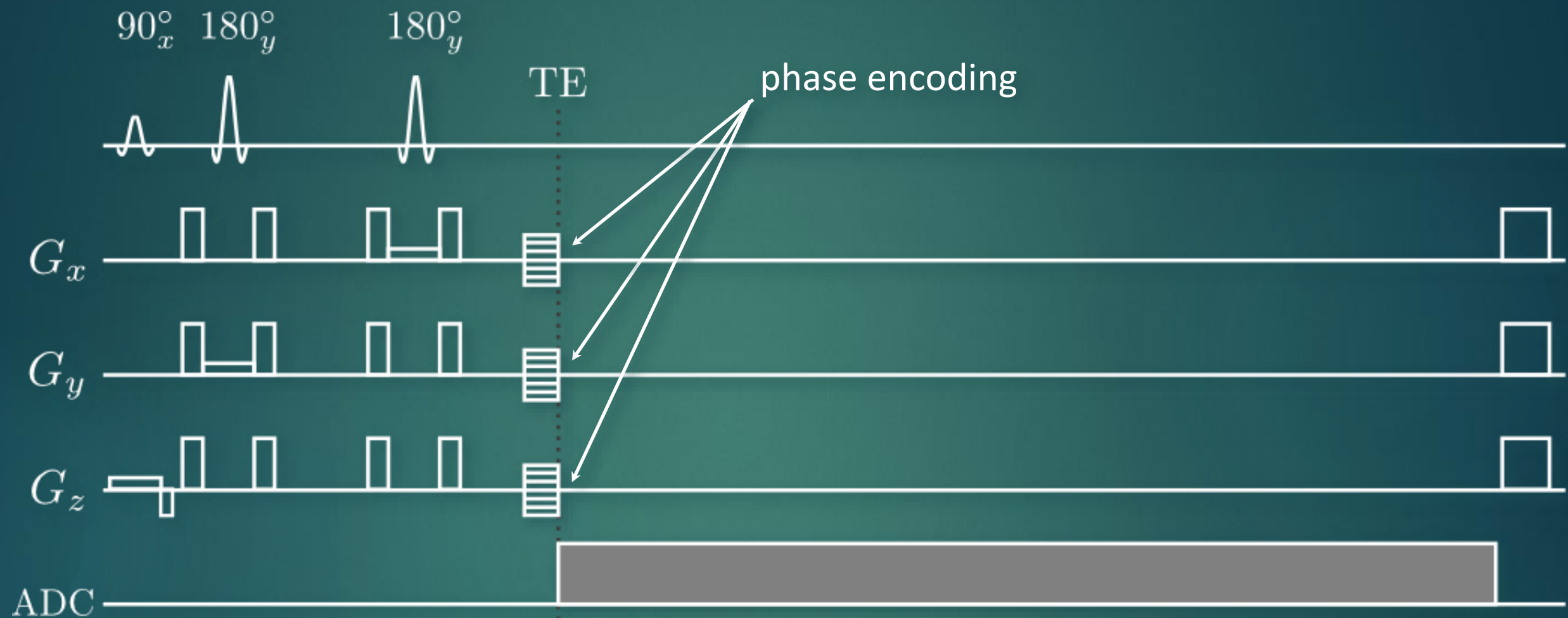

sample 3D spectroscopic imaging pulse sequence

each FID is phase encoded along one  
dimension

Brown 1982

Maudsley 1984

# Sampling Considerations



constant time, vary amplitude

$$\Delta k_x = \frac{1}{\text{FOV}_x} \quad \Delta k_y = \frac{1}{\text{FOV}_y}$$

$$k_x = n \Delta k_x = \frac{n_x}{\text{FOV}_x} = \gamma G_x t$$

$$k_y = n \Delta k_y = \frac{n_x}{\text{FOV}_y} = \gamma G_y t$$

$$G_x = \frac{n_x}{\gamma \text{FOV}_x t} \quad G_t = \frac{n_t}{\gamma \text{FOV}_y t}$$

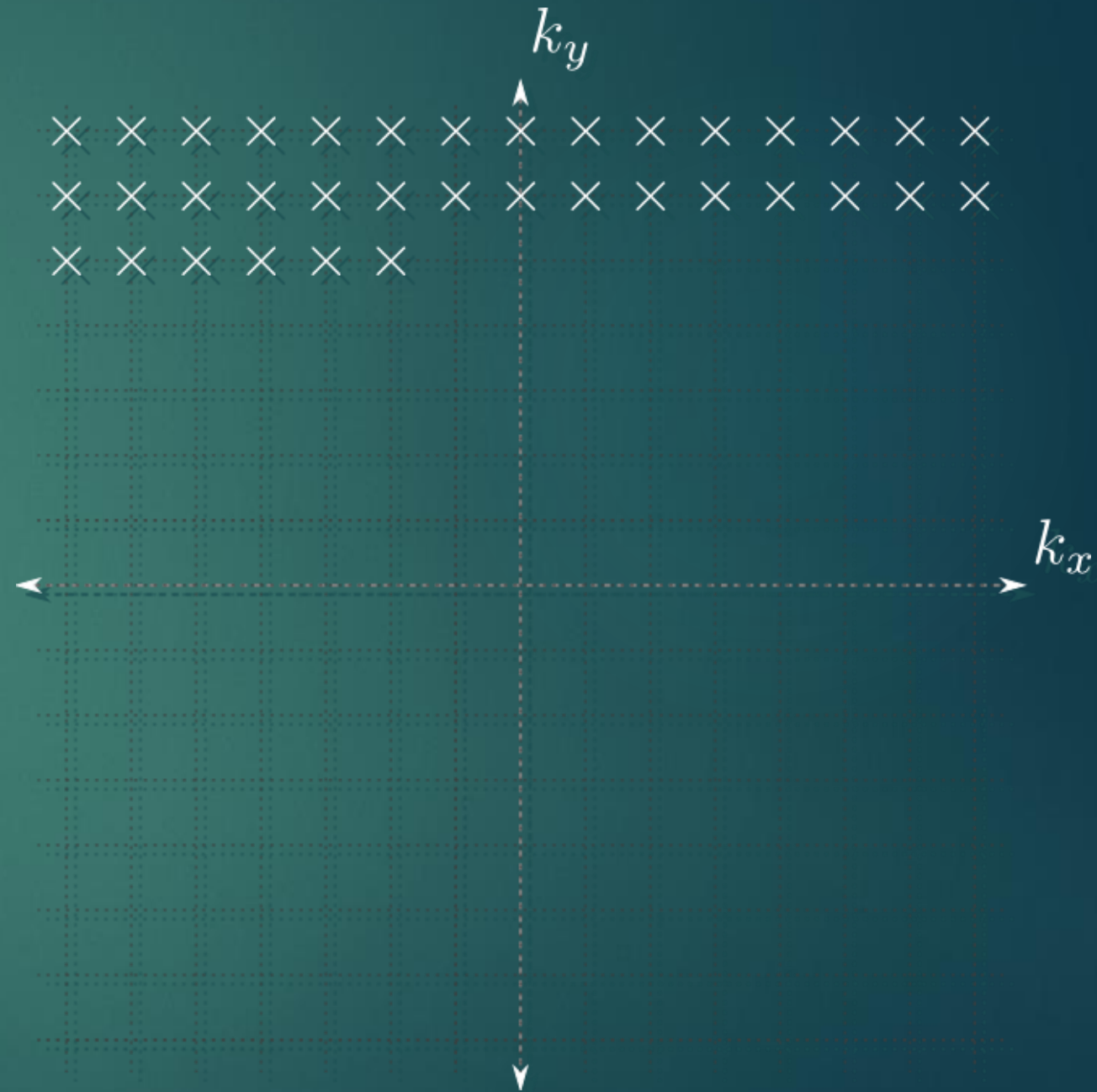

# MRSI

Each k-space point is individually collected on a cartesian grid

Image data is obtained by applying 2D FFT along spatial dimensions

Total acquisition time is thus

$$N_x \times N_y \times TR \times NEX$$

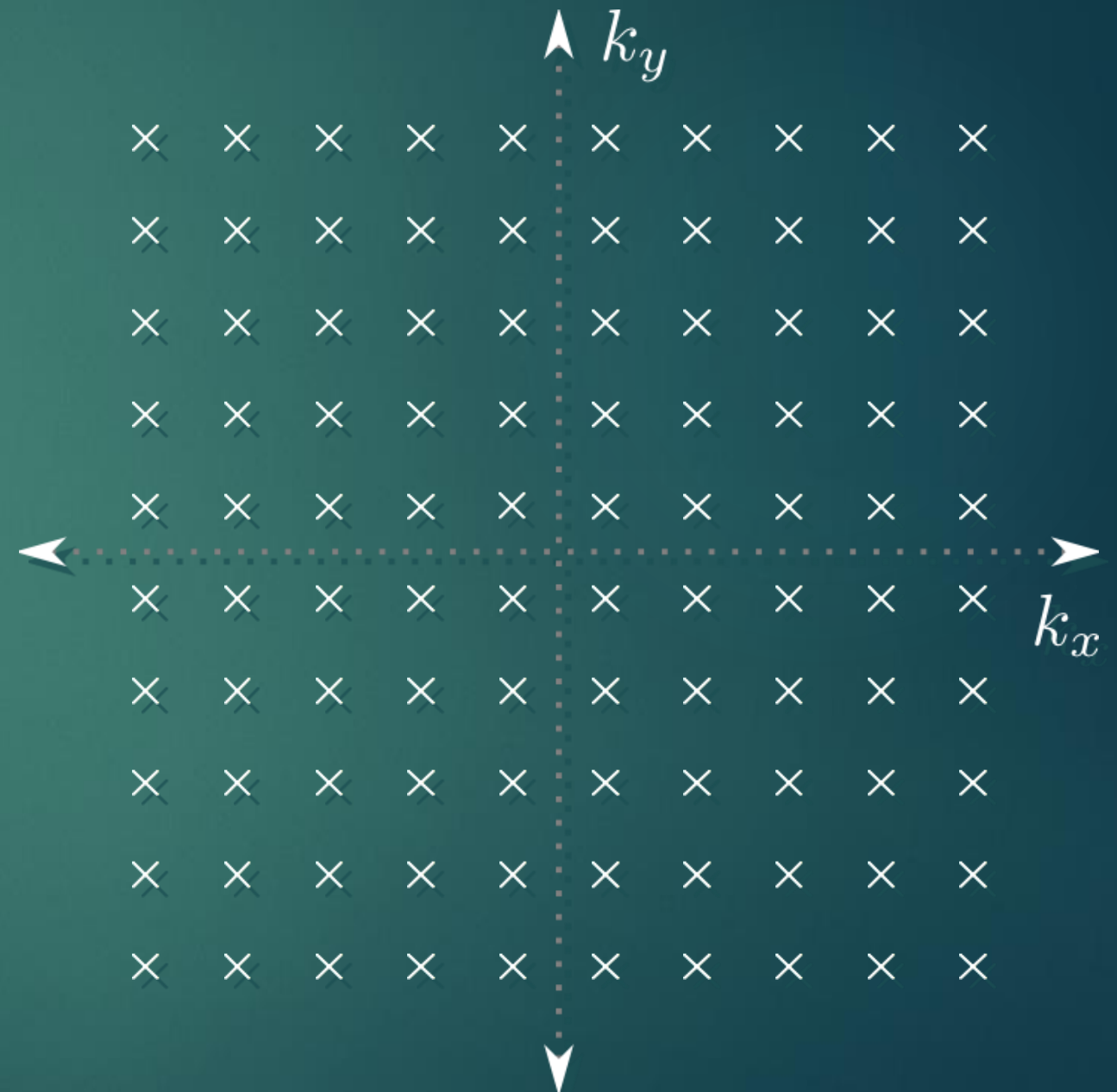



# 3D Spatial Encoding

the amount of time for a CSI scan is thus

$$N_x \times N_y \times N_z \times TR \times NEX$$

for a 32x32x1 scan (2D) with a TR = 1s and 1 average, the scan time is 17 minutes

for a 32x32x16x1 scan (3D) with a TR = 1s and 1 average, the scan time is 4.5 hours

without acceleration techniques, CSI is very slow and inefficient (and low res)

***CHES***  
(global)

***OVS***  
(slice  
localized)

***3D***  
***STEAMCSI***  
***PRESSCSI***

***Data***  
***Acquisition***  
( $N * \Delta t$ )

***Recovery***  
***Time***  
***(TR)***

# MR Spectroscopic Imaging (2-3 Phase Encoded)

localized spectra

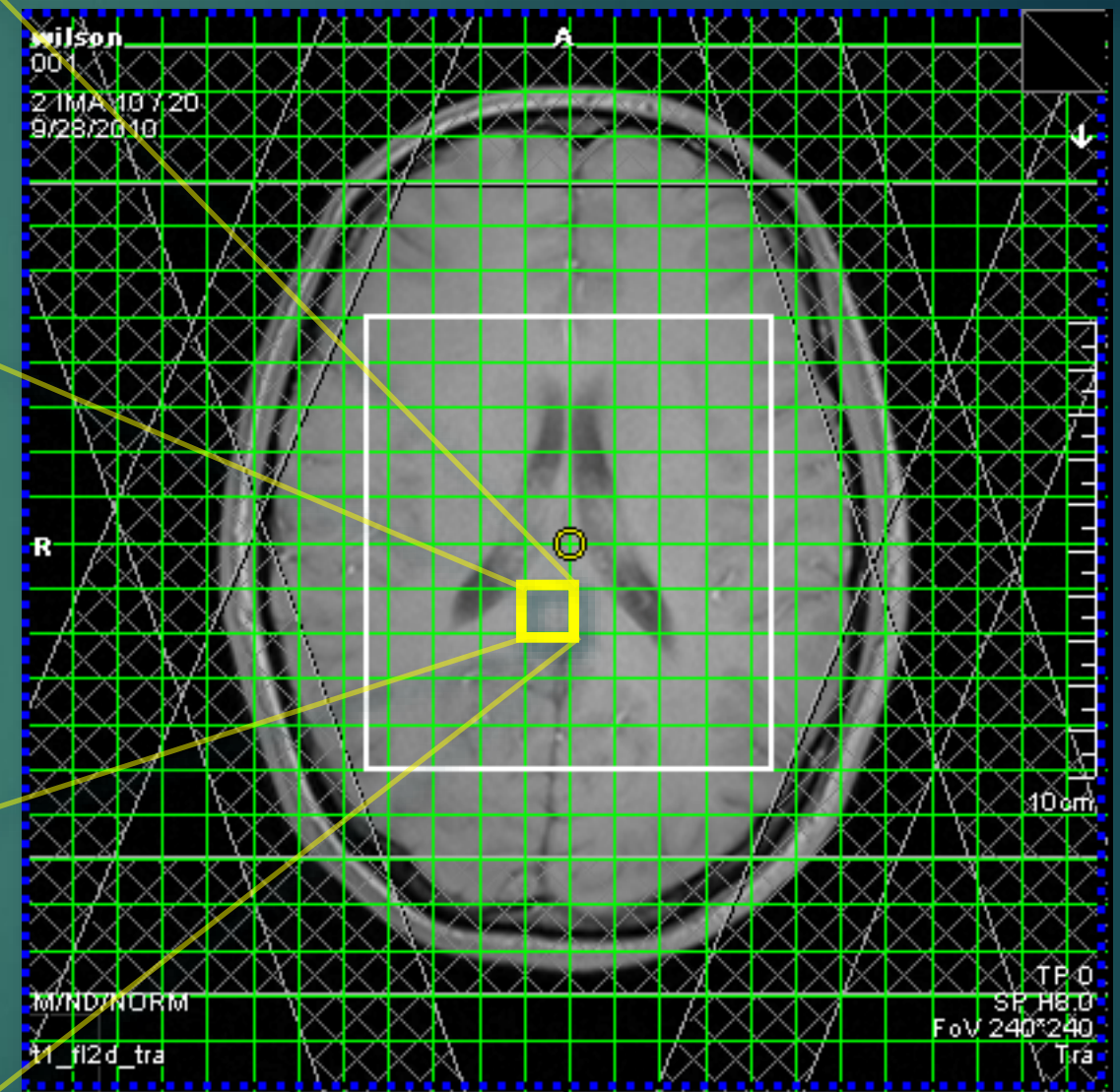
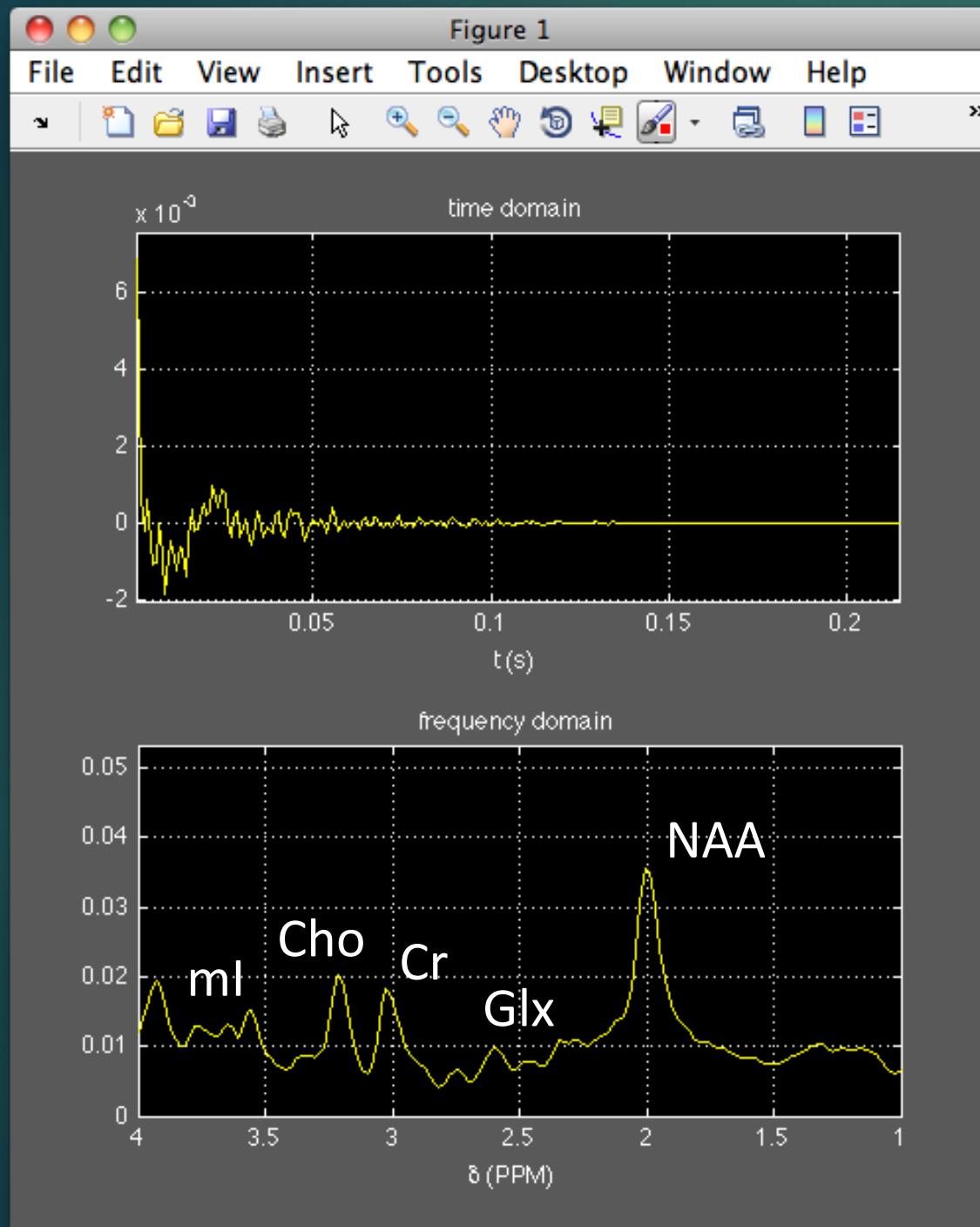



# MR Spectroscopic Imaging (Cont'd.)

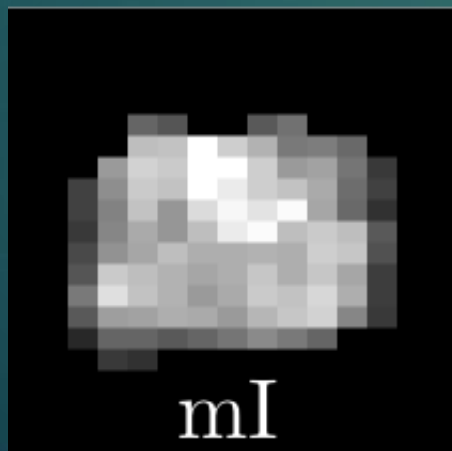
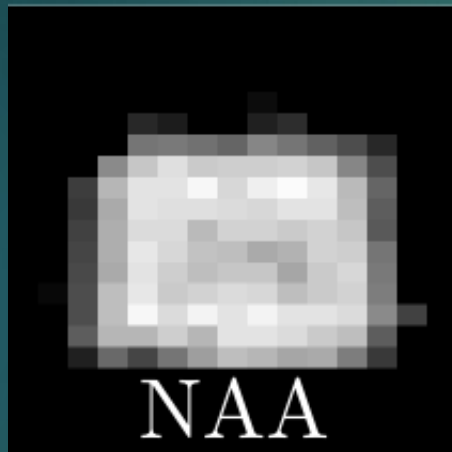

metabolite maps

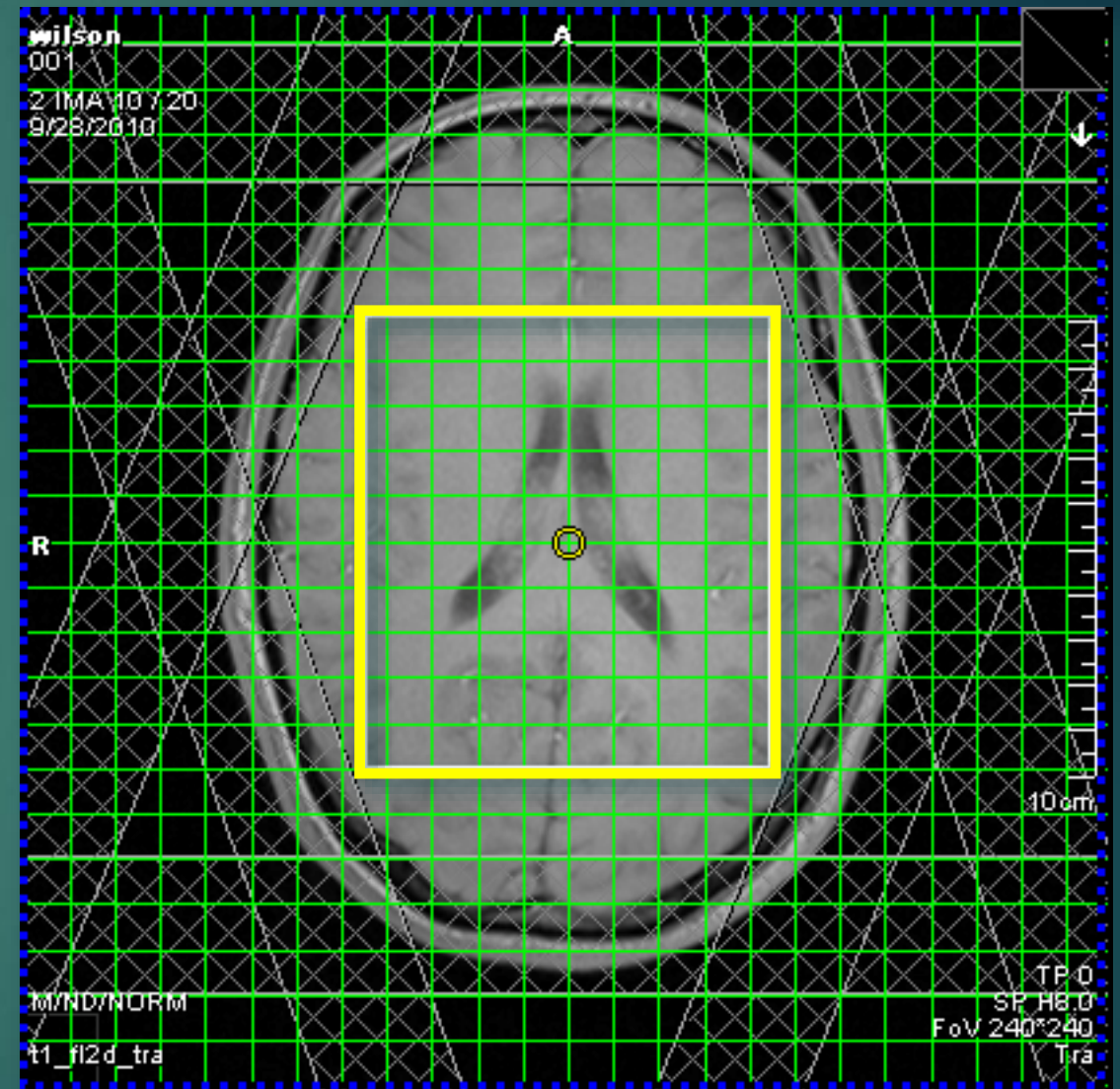



# High resolution metabolite maps

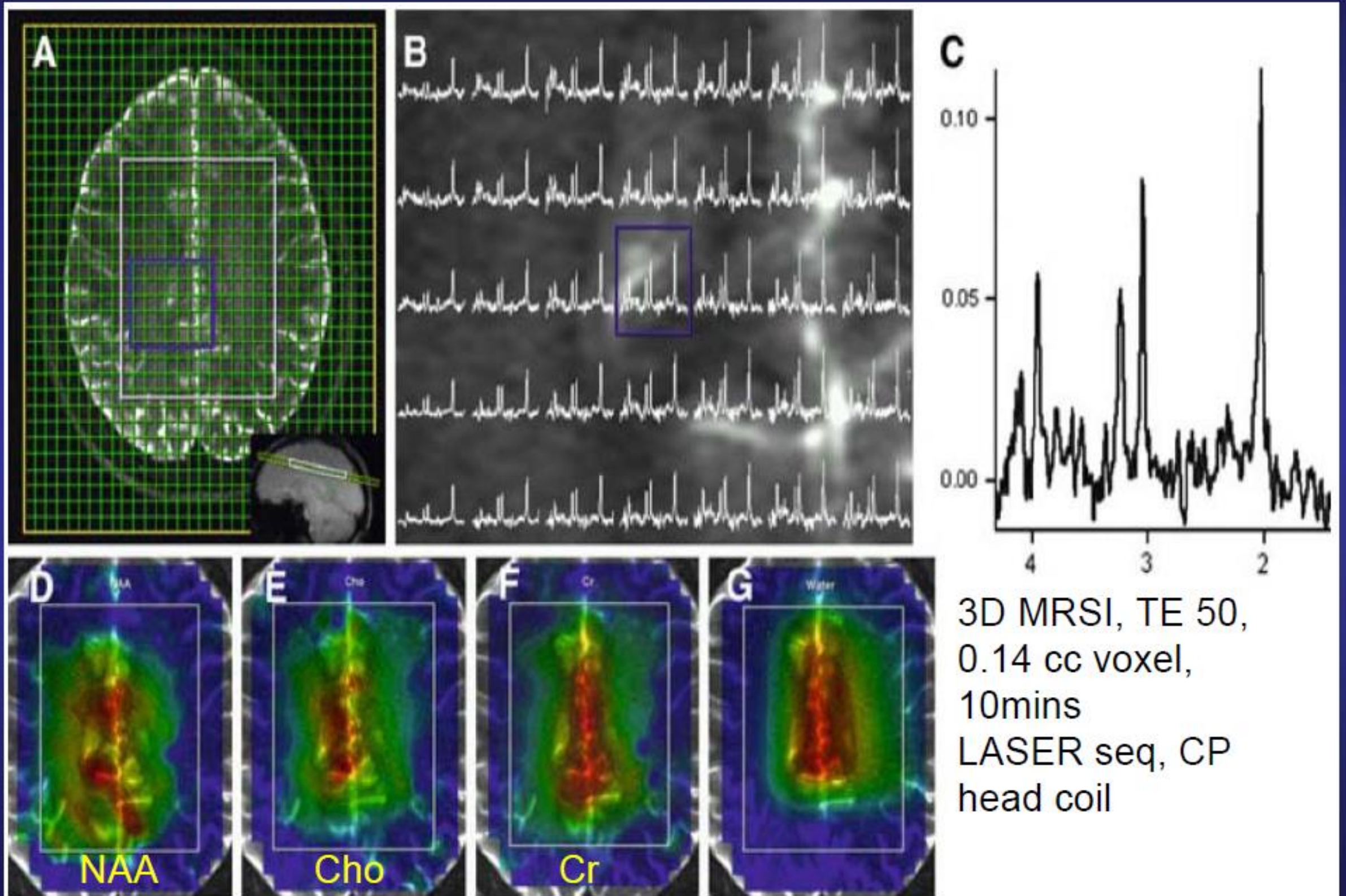



# Metabolic mapping quality – 3T vs 7T

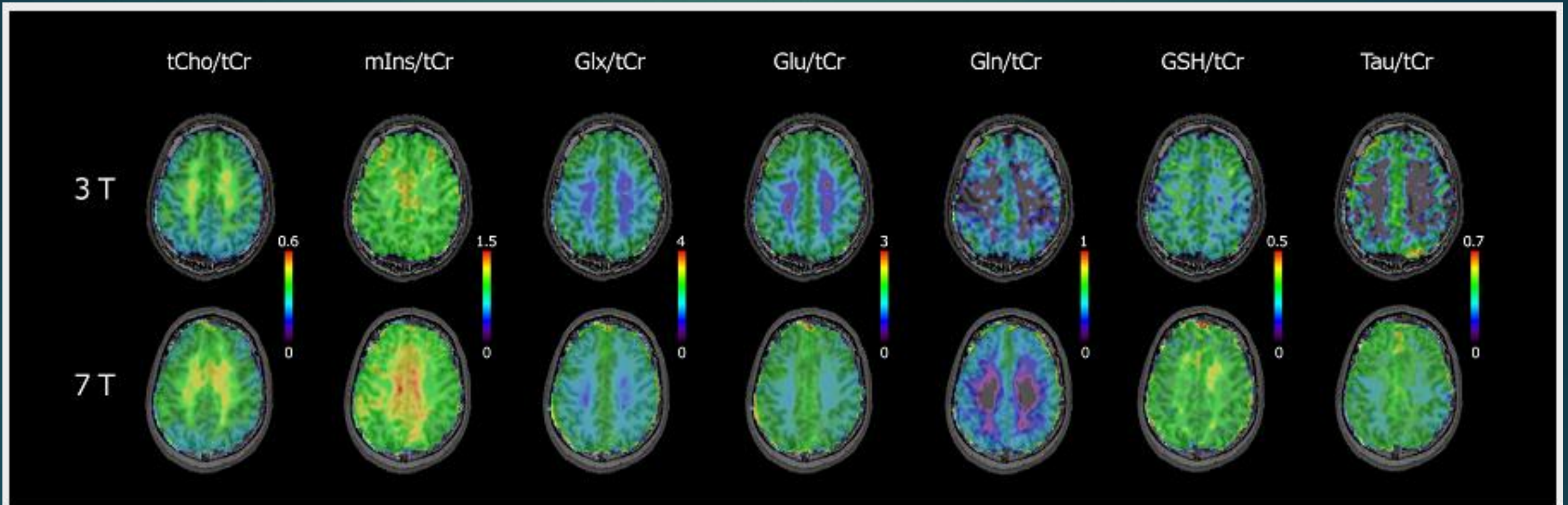

**Figure 4.** Metabolic maps acquired with FID-MRSI at 3T and 7T. Reliable quantification over the whole slice was possible for Glu/tCr, Gln/tCr, GSH/tCr and Tau/tCr at 7T but not at 3T. Values are displayed in a.u.



# How long does it take to perform a multi-voxel 2D/3D MRSI?

**2D MRSI (2 spatial+1spectral):**

$$\begin{aligned}\text{Total duration} &= \text{TR} * \text{NEX} * \text{Nx} * \text{Ny} \\ &= 1\text{s} * 1 * 32 * 32 = 17 \text{ minutes}\end{aligned}$$

**3D MRSI (3 spatial+1spectral):**

$$\begin{aligned}\text{Total duration} &= \text{TR} * \text{NEX} * \text{Nx} * \text{Ny} * \text{Nz} \\ &= 1\text{s} * 1 * 32 * 32 * 16 = 4.53 \text{ hours} \\ &= 1\text{s} * 1 * 16 * 16 * 8 = 34 \text{ minutes}\end{aligned}$$

# Acceleration Techniques

## The goal

- to reduce the number of excitations in order to reduce the total scan time (1-10 minutes)

## The strategies

- Selective Averaging
- Parallel Imaging
- Turbo Spin Echo (TSE) techniques
- Echo-Planar (EP) techniques
- Concentric Ring Trajectories (SI-CONCEPT)
- Radial (Golden Angle View Ordering) and TV regularizer

# Fast MRSI

- ▶ Elliptical weighting
  - ▶ Reduced spatial sampling of k-space with only the central ellipsoid being acquired (reduction factor typically = 2)
- ▶ Parallel Imaging Reconstruction
  - ▶ Reduced acquisitions of k-space by increasing the spacing between k-space samples. Additional spatial information from multiple receiver coils is then used to increase the spatial FOV to the original size.

## Selective Averaging

Average the parts of k-space with greater intensity

Significantly reduces total scan time

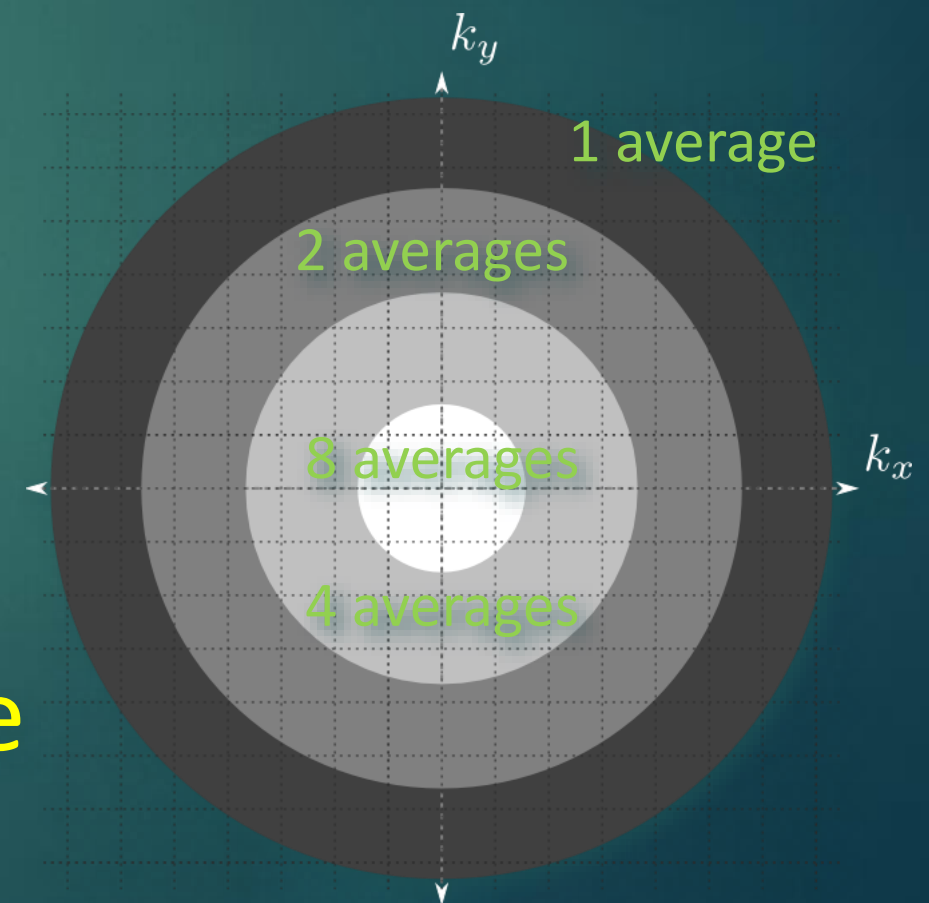



# MRI/MRSI Data Display

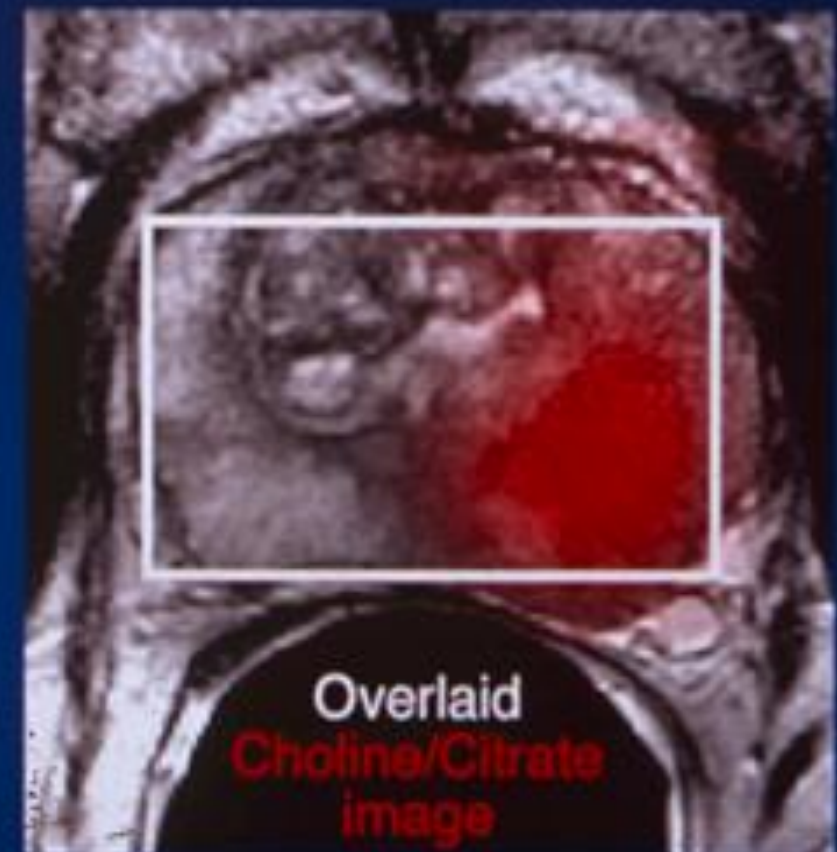
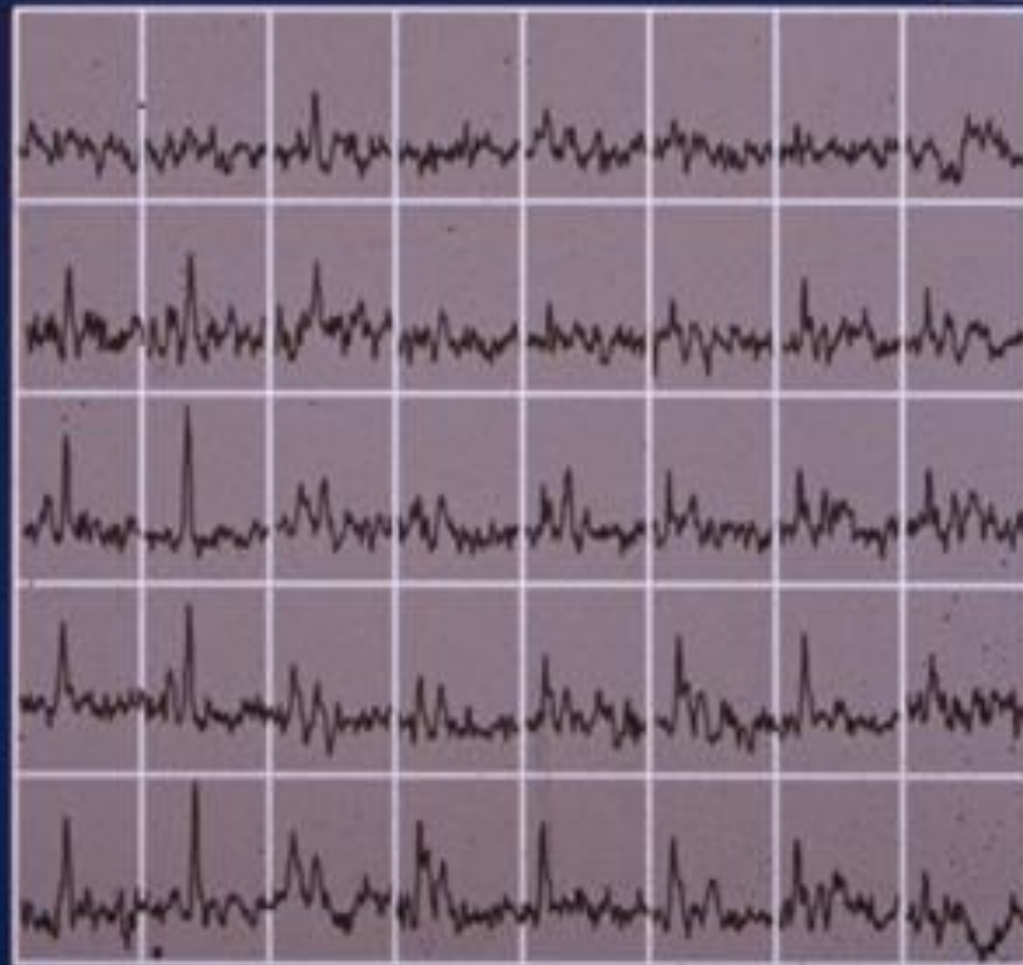
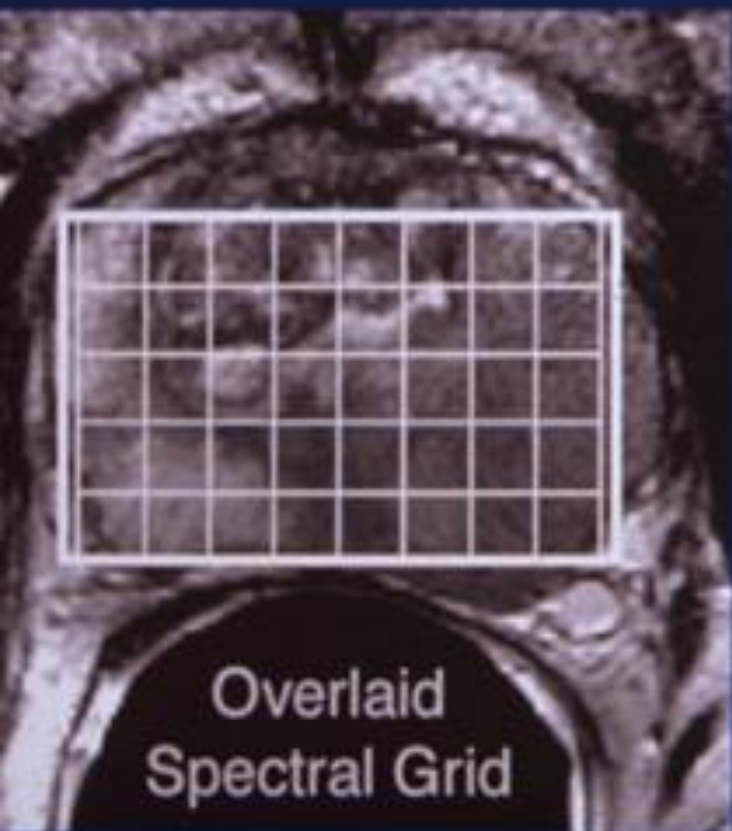
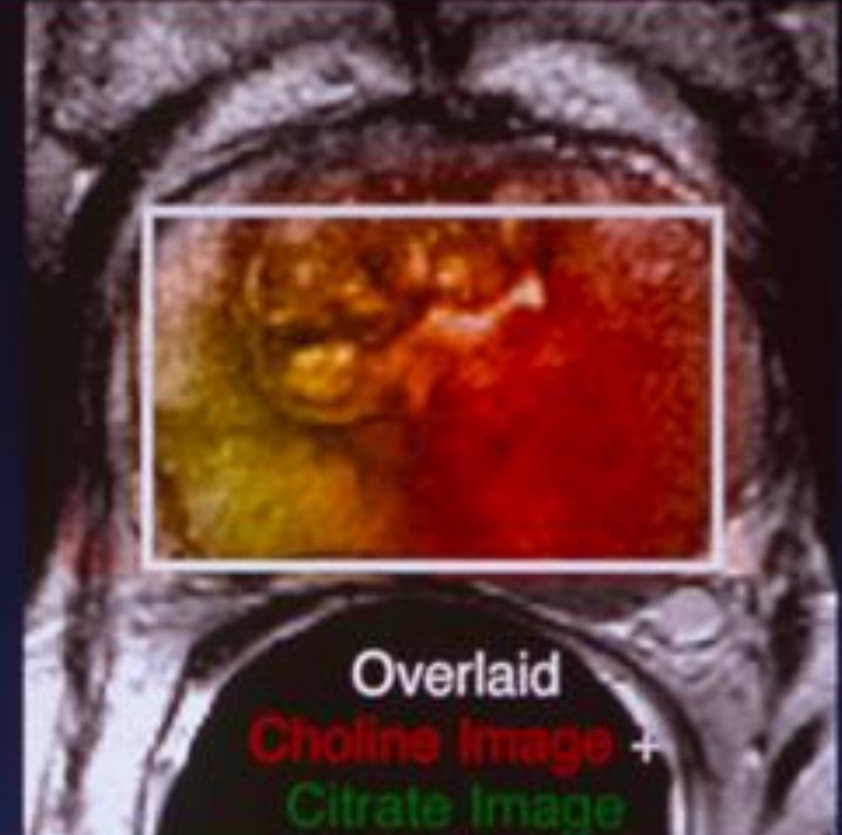
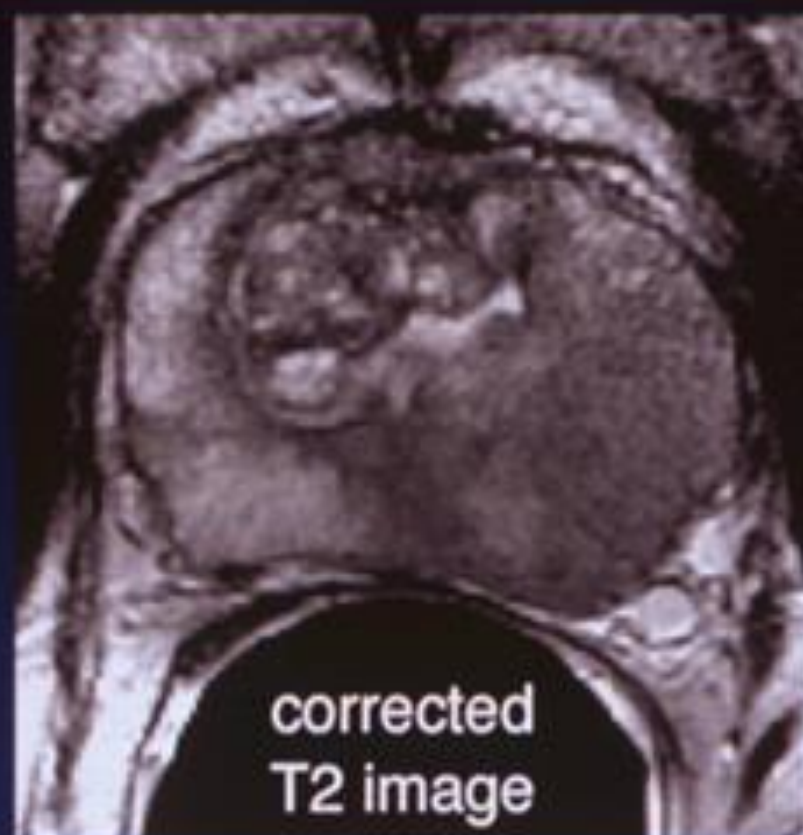
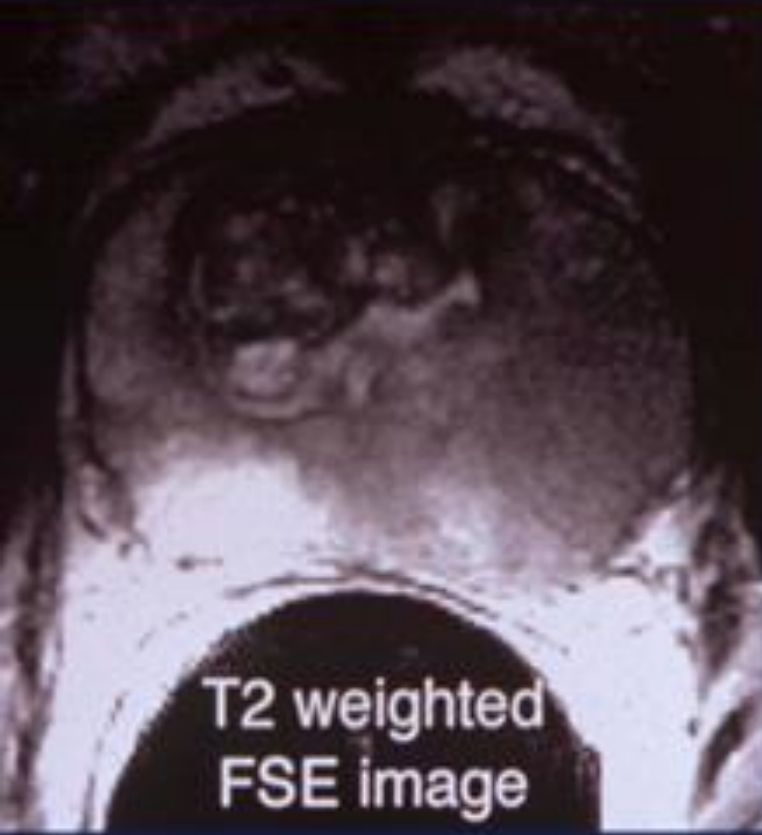

# Parallel Imaging

## Multi-coil reconstruction (SENSE/GRAPPA)

### advantages

- reduced scan time

### disadvantages

- reduced SNR from reduced number of excitations



# Echo-Planar Spectroscopic Imaging (EPSI)

echo-planar spectroscopic imaging uses a repeated time-varying readout gradient to collect the same spatially encoded information as a function of time

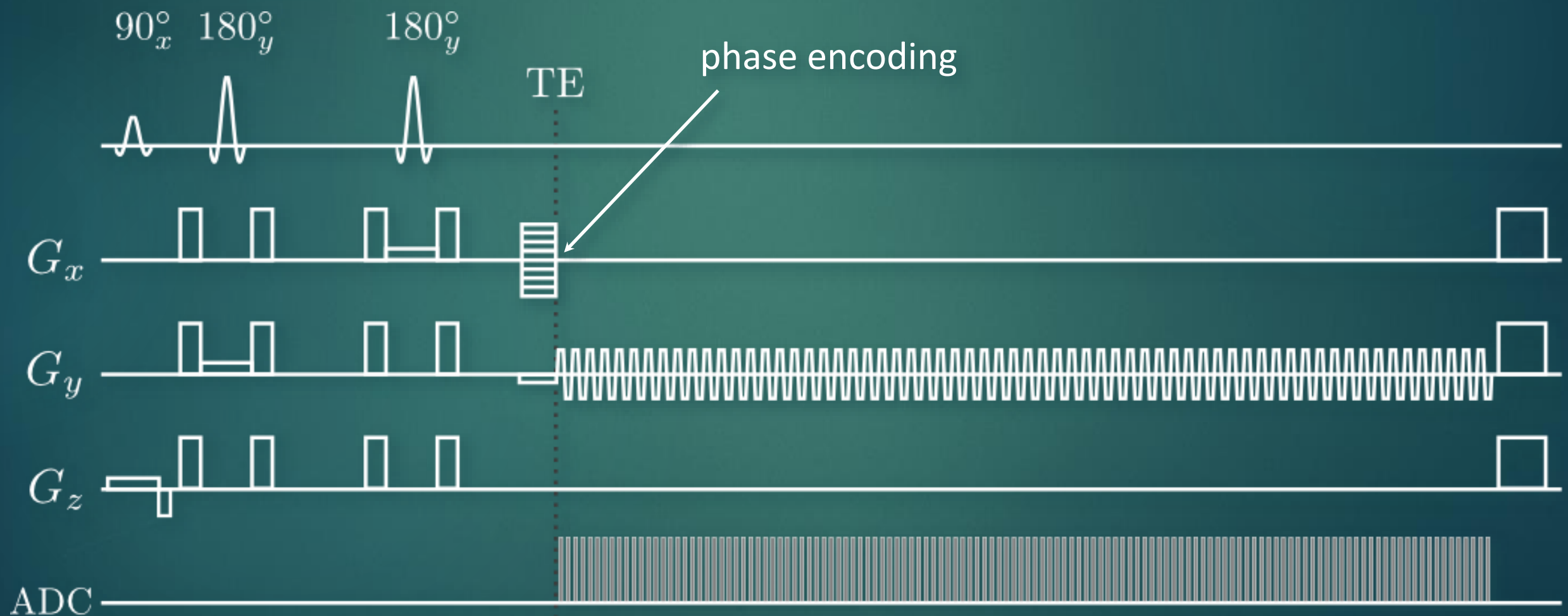

what is the effect of the repeated bipolar gradient readout?

Mansfield 1984, Posse 1994, Lipnick 2008



# Echo-Planar SI

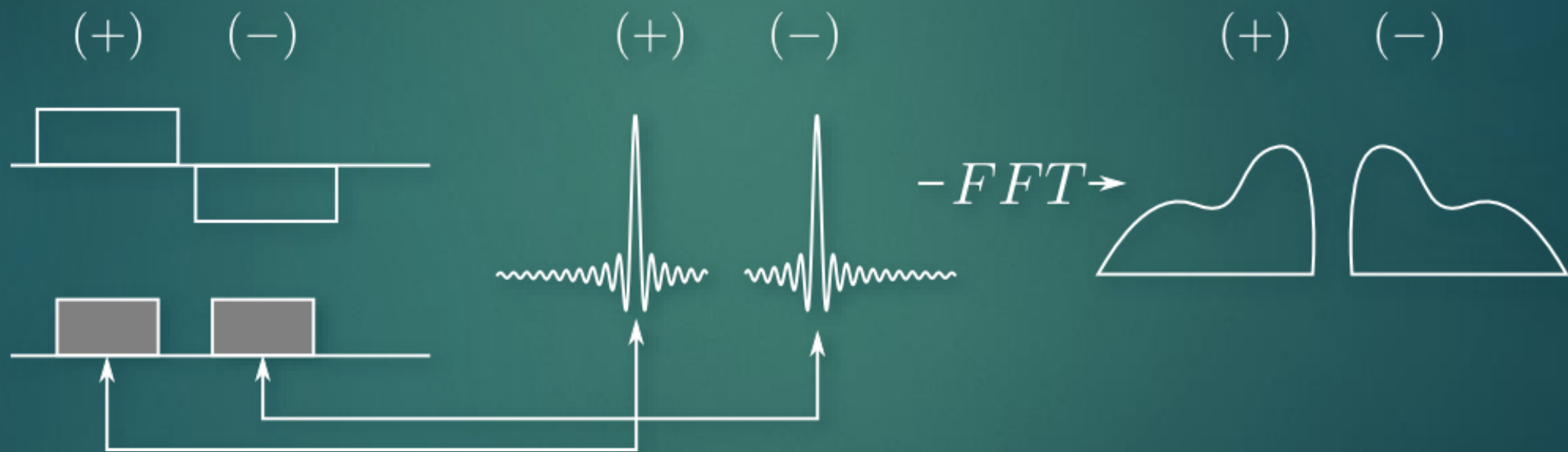
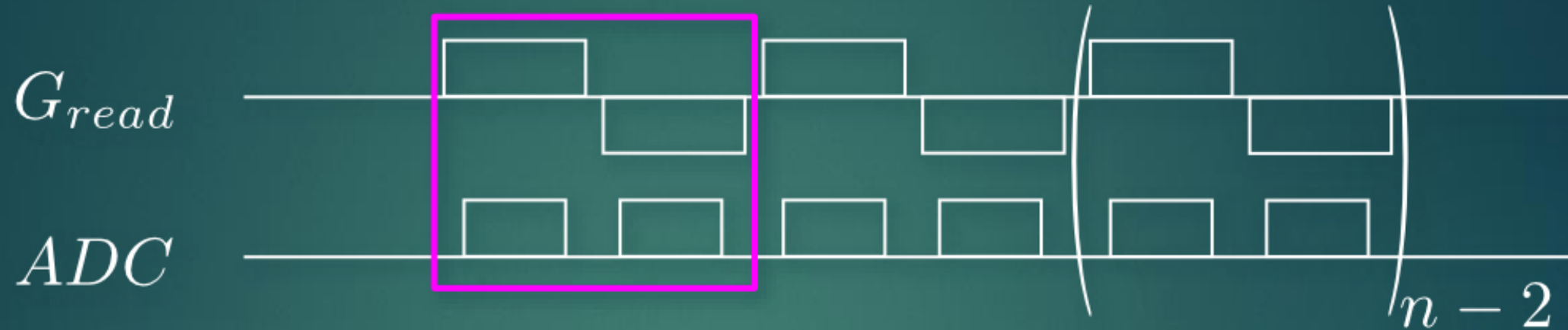

two sets of echoes (odd and even) form  
which are mirror images of each other

# Echo-Planar SI

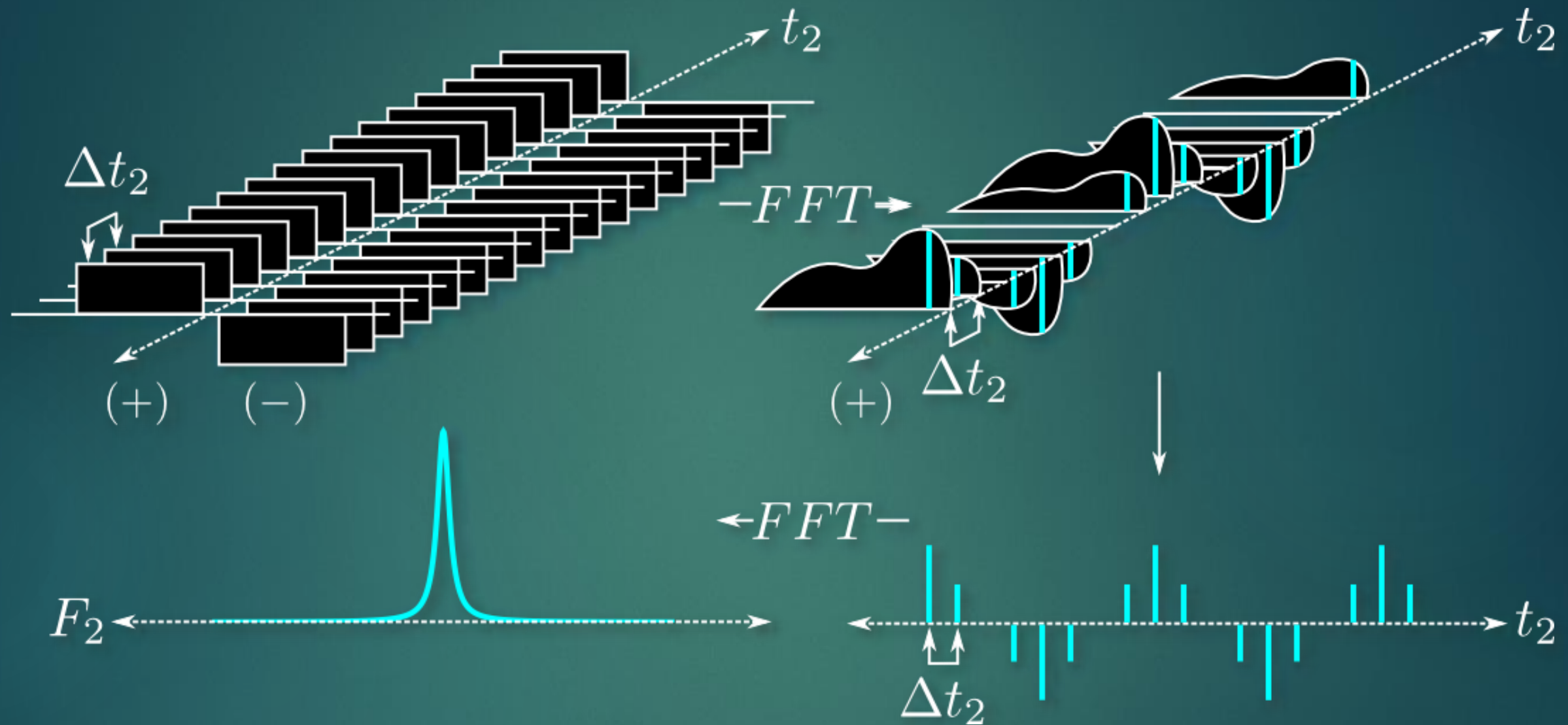

the repeated nature of the readout gradients  
 spatially encodes as a function of time

A single line in k-space is collected in a single excitation

Image data is obtained by applying 2D FFT along spatial dimensions

Total acquisition time is thus

$$N_x \times TR \times NEX$$

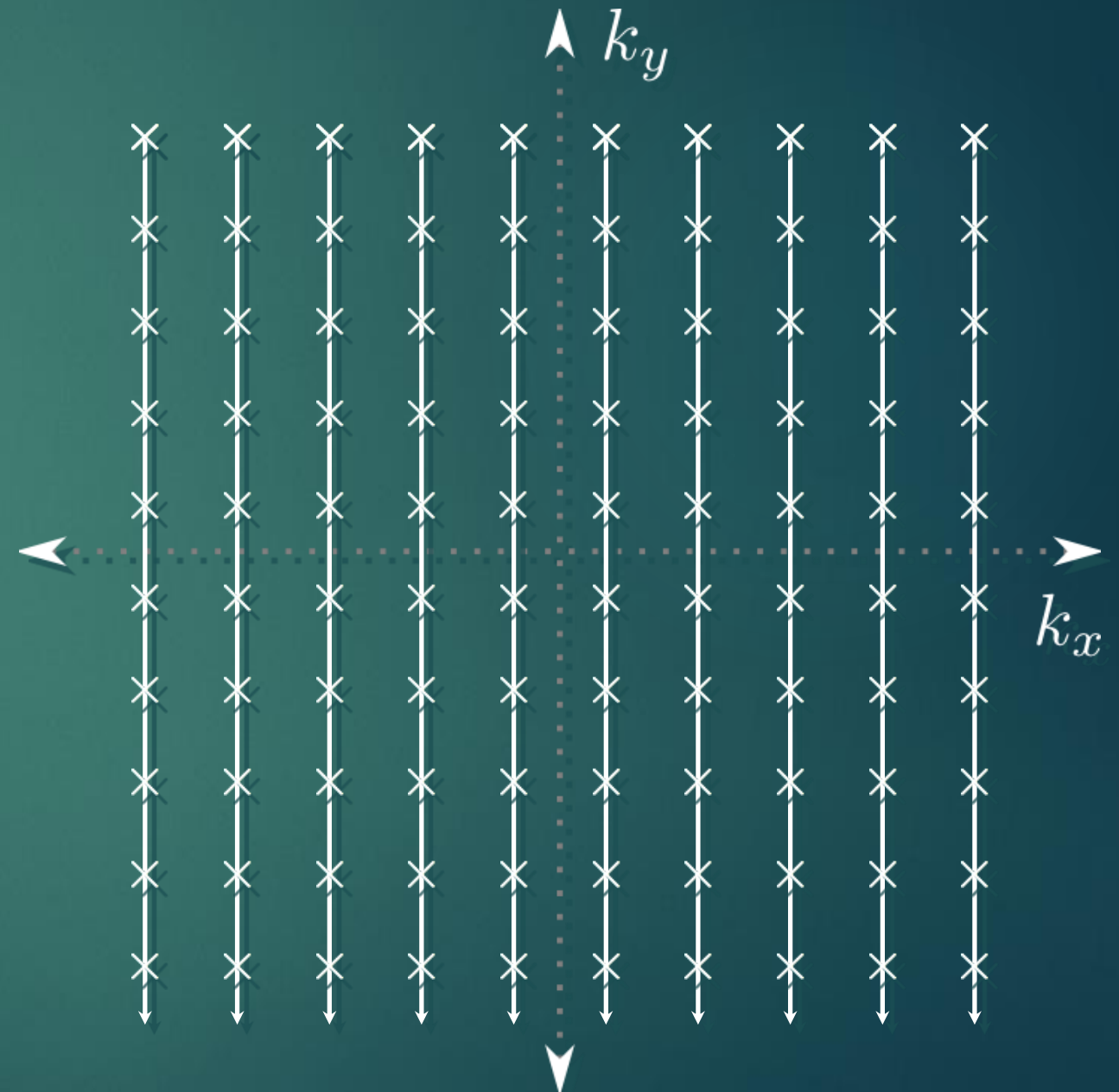



# Echo-Planar SI

the amount of time for a MRSI scan is thus

$$N_x \times N_z \times TR \times NEX$$

for a 32x32x16 scan (3D) with a TR = 1s and 1 average, the scan time is 8.5 minutes

**Using all 3 phase-encoding,**

**3D MRSI (3 spatial+1spectral):**

$$\begin{aligned} \text{Total duration} &= TR * NEX * N_x * N_y * N_z \\ &= 1s * 32 * 32 * 16 = 4.5 \text{ hours} \end{aligned}$$

significant reduction in scan time!

# Echo-Planar SI

## advantages

- significantly reduced scan time

## disadvantages

- echo-planar readout creates undesired eddy currents which can distort spectra
- reduced SNR from reduced number of excitations
- very demanding on the hardware (reduced spectral bandwidth)

# Why Concentric Circular sampling?

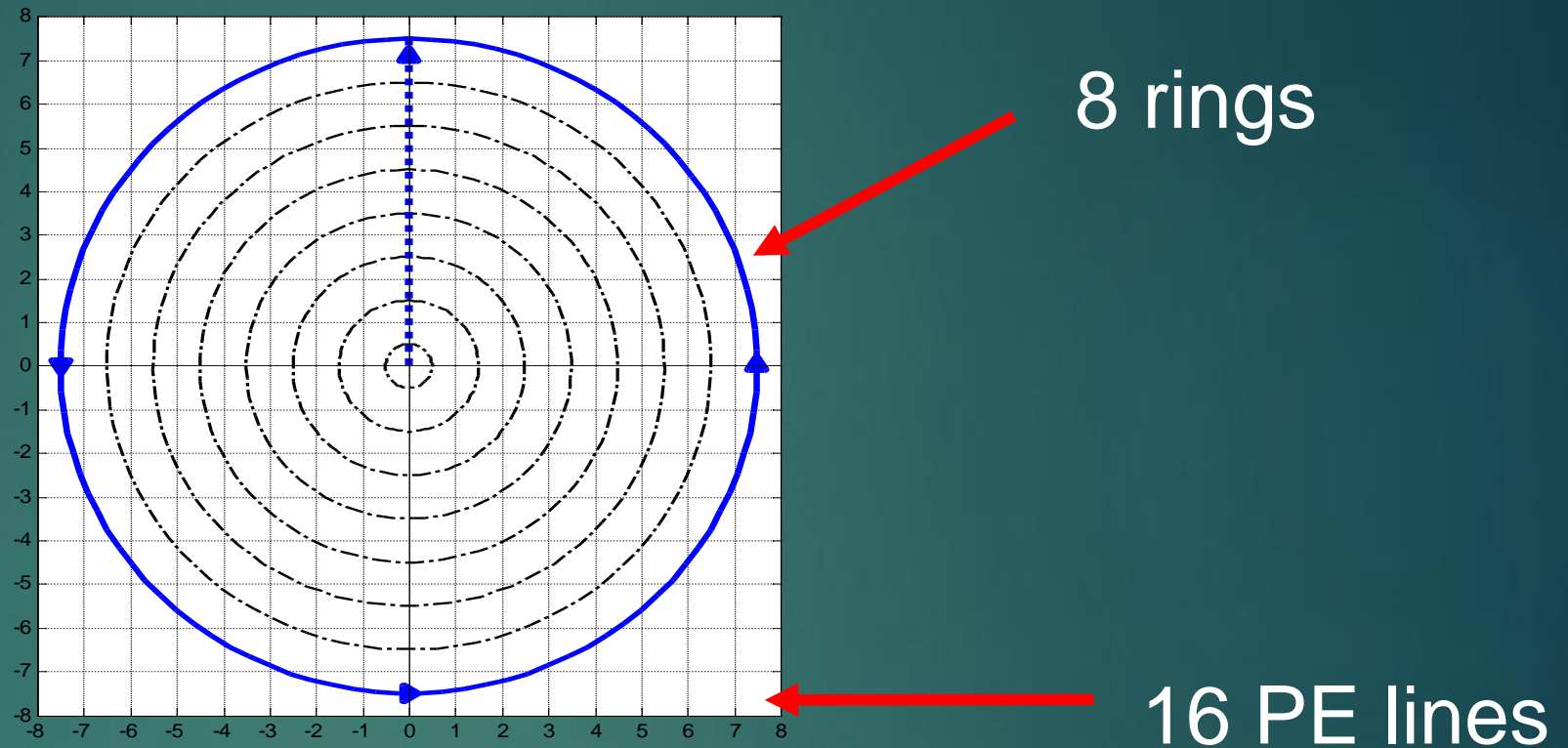

- ▶ More efficient k-space sampling due to symmetry of concentric circles → half the number of excitations required for similar k-space coverage
- ▶ Outer corners of k-space contain little signal and are usually filtered away anyway



# Concentric Circles (SI-CONCEPT)

A single ring in k-space  
is collected in a single  
excitation

Image data **cannot** be  
processed by 2D FFT since  
it is not cartesian

Total acquisition  
time is thus

$$\frac{1}{2} N_x \times TR \times NEX$$

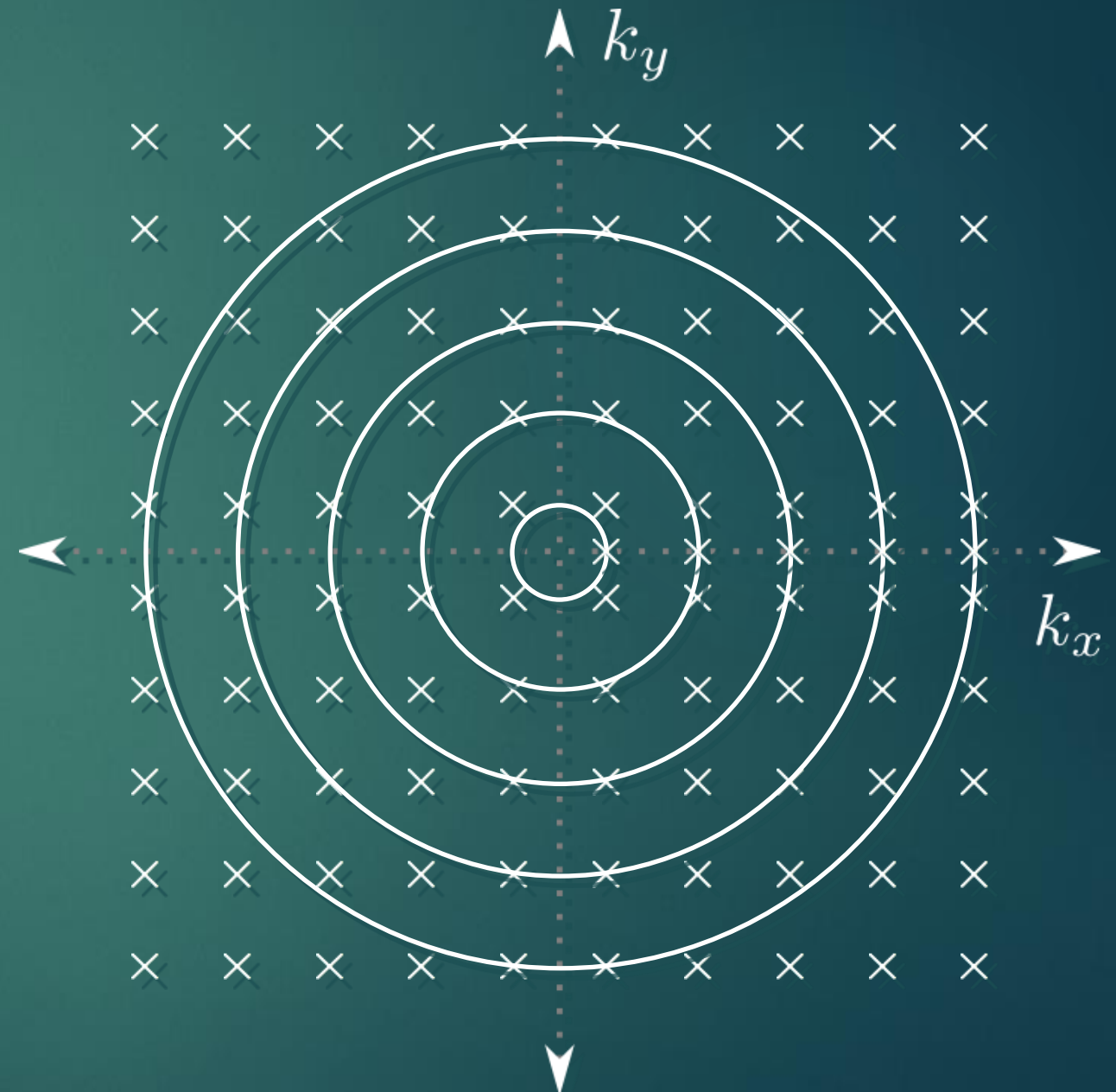

# What is Concentric Circular ?

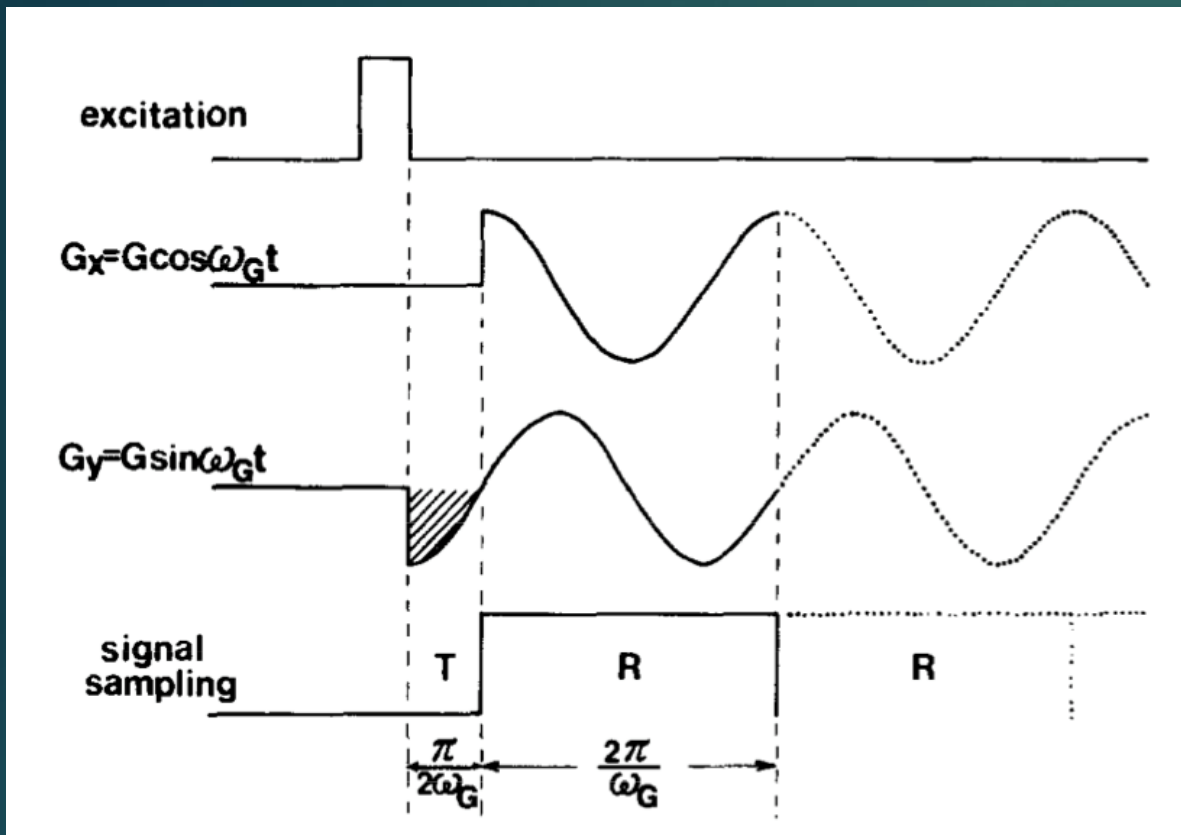

Circular k-space trajectory defined

$$k_x(t) = -k_n \sin\left(\frac{2\pi}{T}(t - TE)\right)$$

$$k_y(t) = +k_n \cos\left(\frac{2\pi}{T}(t - TE)\right)$$

where  $k_n$  is the radius of the  $n$ th ring and  $T$  is the spectral dwell time in the direct dimension

Gradient waveforms are thus given by

$$G_x(t) = -\frac{4\pi^2 k_n}{\gamma T} \cos\left(\frac{2\pi}{T}(t - TE)\right)$$

$$G_y(t) = -\frac{4\pi^2 k_n}{\gamma T} \sin\left(\frac{2\pi}{T}(t - TE)\right)$$

# SI-CONCEPT Pulse Sequence

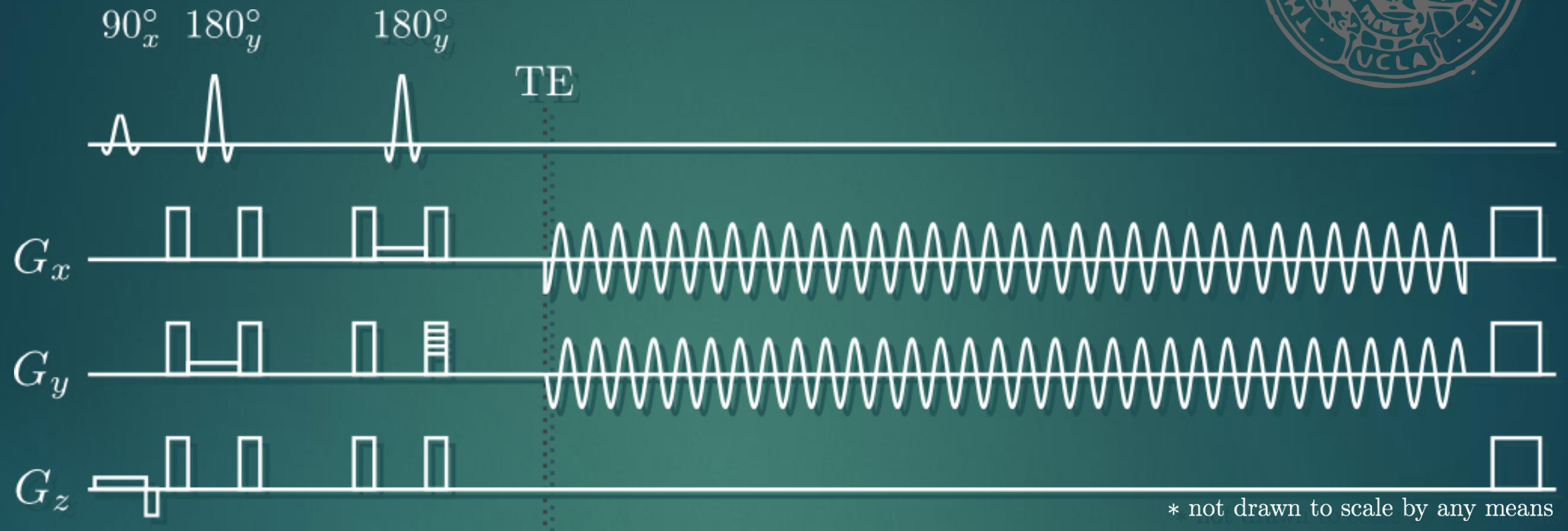

The use of a concentric k-space trajectory is readily applied to ordinary CSI sequences

Repeatedly tracing the same circle in k-space encodes both spatial and spectral information



# Concentric Circles

Convert polar data to cartesian?

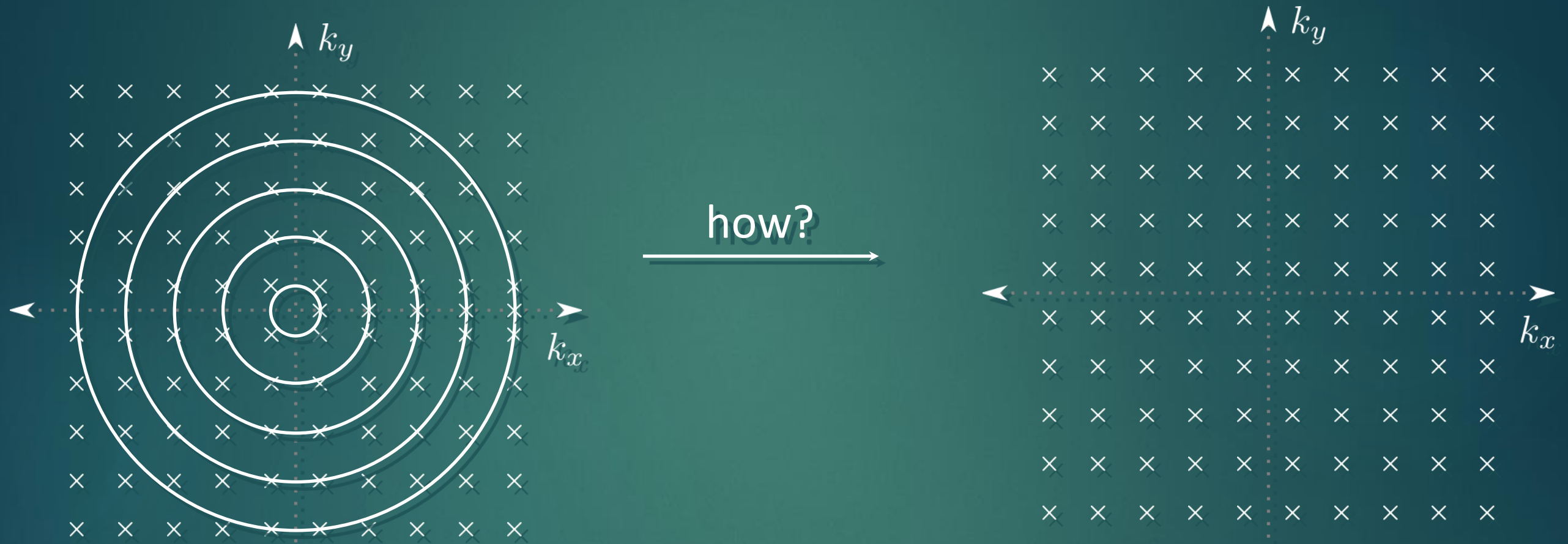

Gridding takes any arbitrary k-space trajectory and convolves it onto a cartesian grid

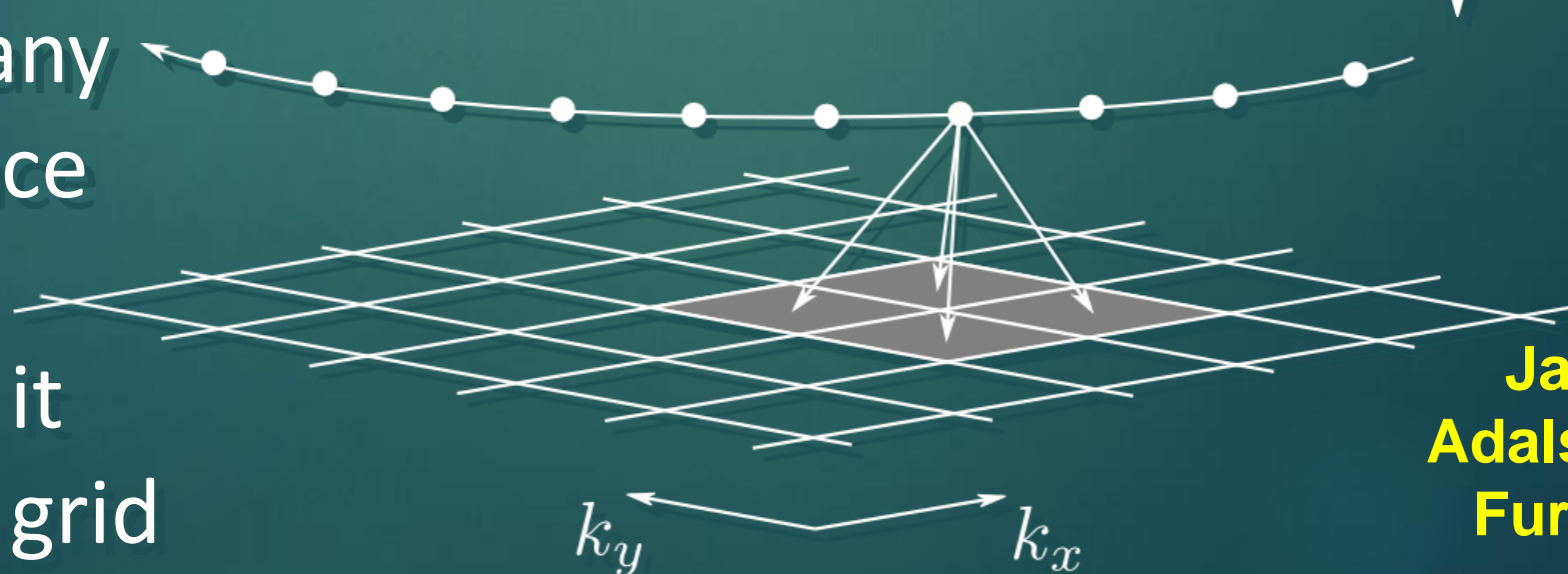

**Jackson 1991**  
**Adalsteinsson 1998**  
**Furuyama, 2012**

# Concentric Circular Imaging - Polar Data

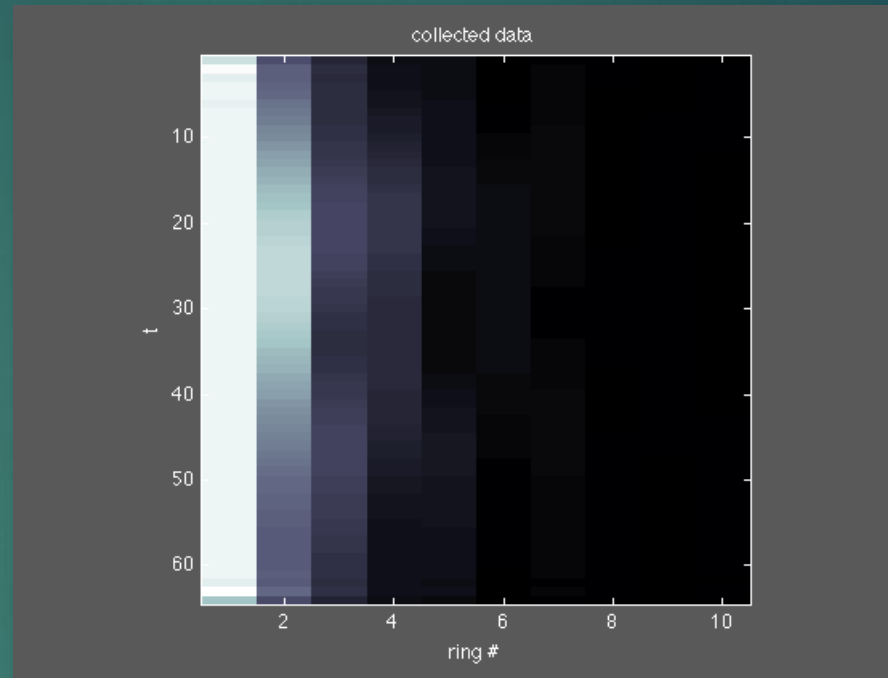
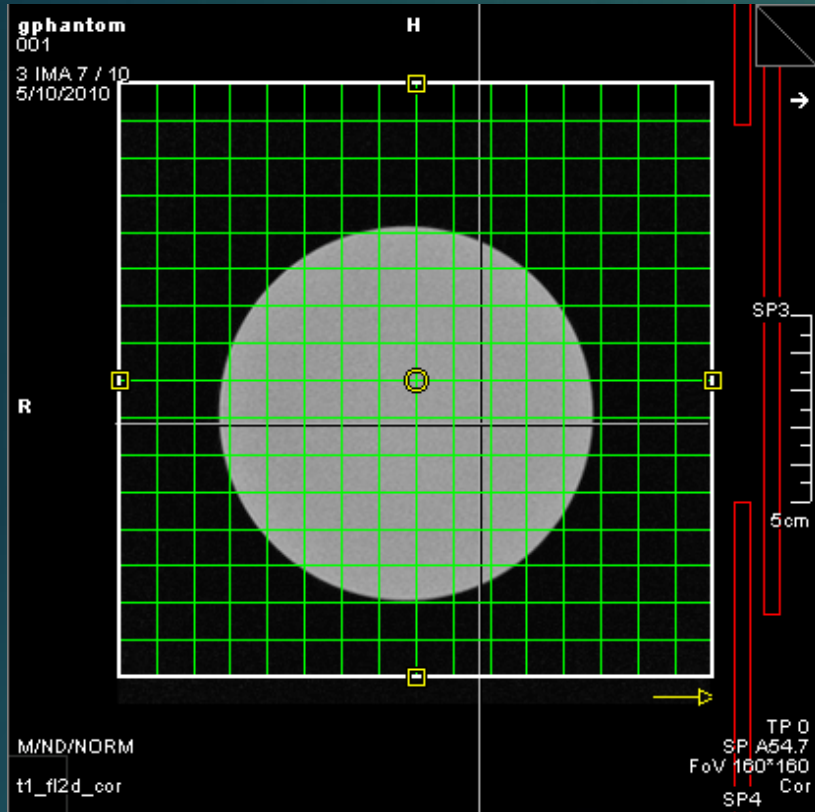

JK Furuyama, NE Wislon,  
MA Thomas MRM 2012

## - reconstructed Human Brain Spectra

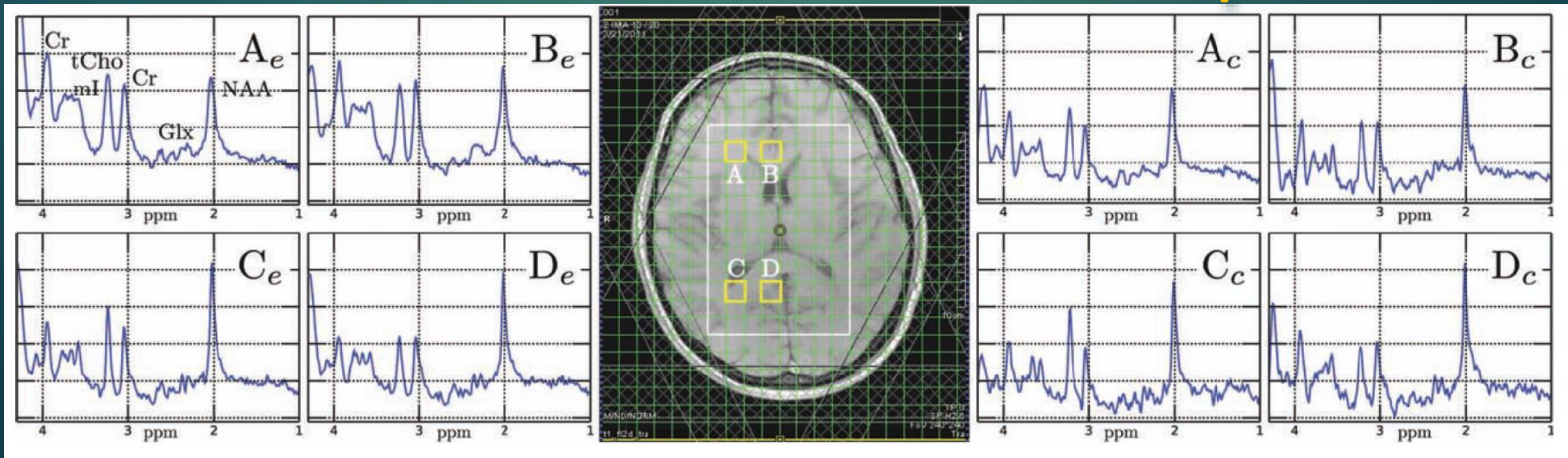



# MRSI vs. EPSI vs. SI-CONCEPT



$$N_x \times N_y \times TR \times NEX \quad \text{-MRSI}$$

$$N_x \times TR \times NEX \quad \text{-EPSI}$$

$$\frac{1}{2} N_x \times TR \times NEX \quad \text{-SI-CONCEPT}$$

Faster!

*Hingerl et al. Inv Rad. 2020*  
.....Brain coverage among all measured matrix sizes ranging from a  $32 \times 32 \times 31$  matrix with  $6.9 \times 6.9 \times 4.2$  mm nominal voxel size acquired in ~3 minutes to an  $80 \times 80 \times 47$  matrix with  $2.7 \times 2.7 \times 2.7$  mm nominal voxel size in ~15 minutes for different brain regions.

*Emir and coworkers, MRM 2020*  
“A density-weighted concentric-ring trajectory metabolite-cycling MRSI technique was implemented to collect data with a nominal resolution of 0.25 mL within 3 minutes and 16 seconds.”



# Advantages of Concentric Circular Trajectories

- Less demanding on gradient hardware → higher spectral BW achievable (required at higher field strengths to prevent spectral aliasing)
- Eddy currents not as severe especially for *inner* k-space data
- Continuous readout during acquisition (EP-COSY without ramp sampling only samples during ~75% readout)
- Inherently less sensitive to motion artifacts
- **Lower maximum slew rates for equal resolutions and spectral BW**
- ▶ (> 50% less for actual scan parameters used)

## Drawbacks

- Sampling during time-varying readout gradients leads to increased noise variance<sup>1</sup>
  - SNR gains from averaging compensate so that sensitivity per time in both sequences is similar
    - More complicated post-processing
      - Data must be regridded in order to apply FFT
      - Alternatively, projection-reconstruction (PR) algorithms can be applied using inverse radon transform



Emir 2017; Chew 2018;  
Steel 2018;; Kodibagkar 2019; Hingerl 2020

1) Pipe J and Duerk J, MRM 1995

# Further Acceleration???

## Projection Reconstruction/Radial

### Original MRI Sequence

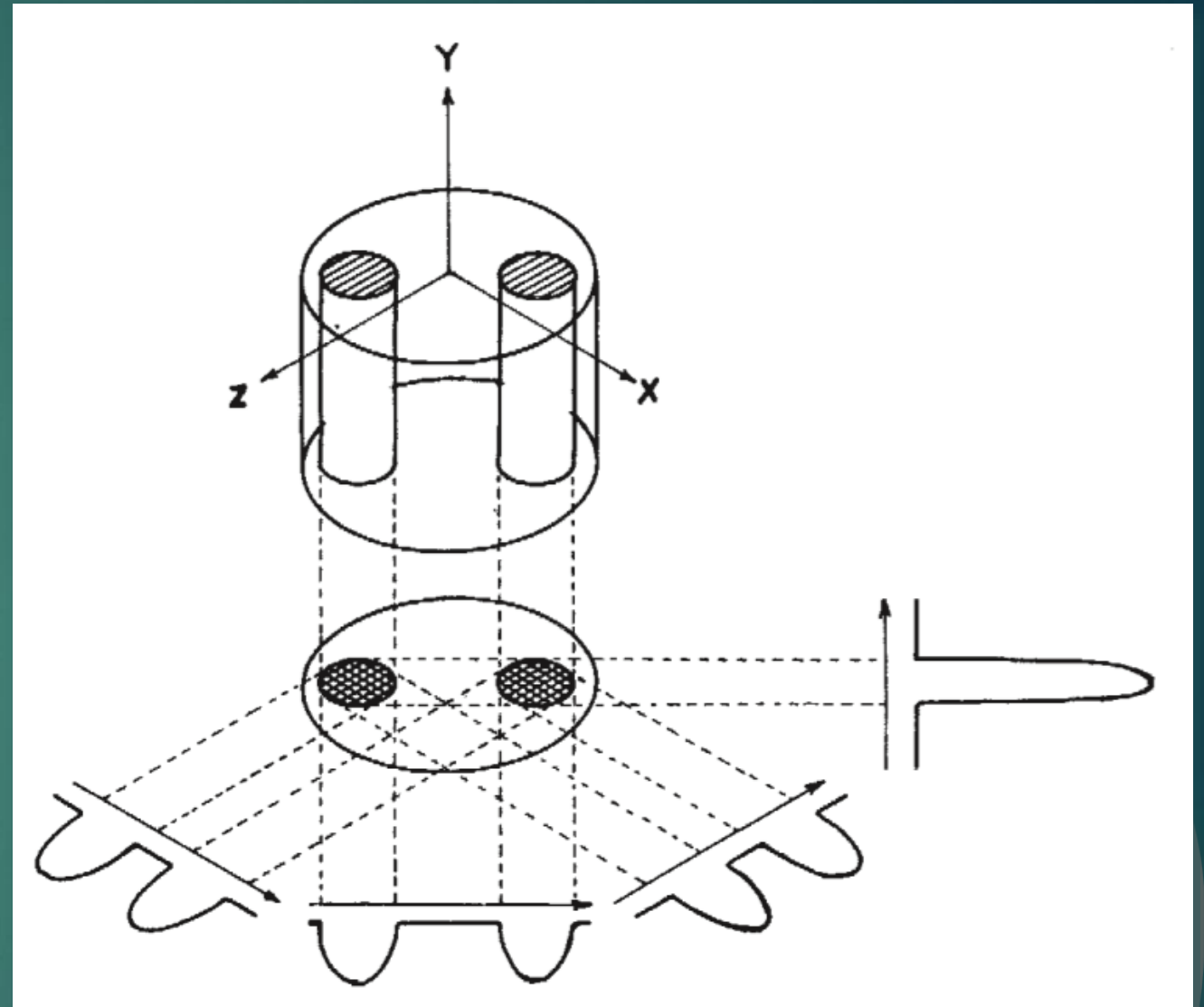

Lauterber P, *Nature* 242, 190-191 (1973)

Series of projections taken at different angles

# Radial Spectroscopic Imaging

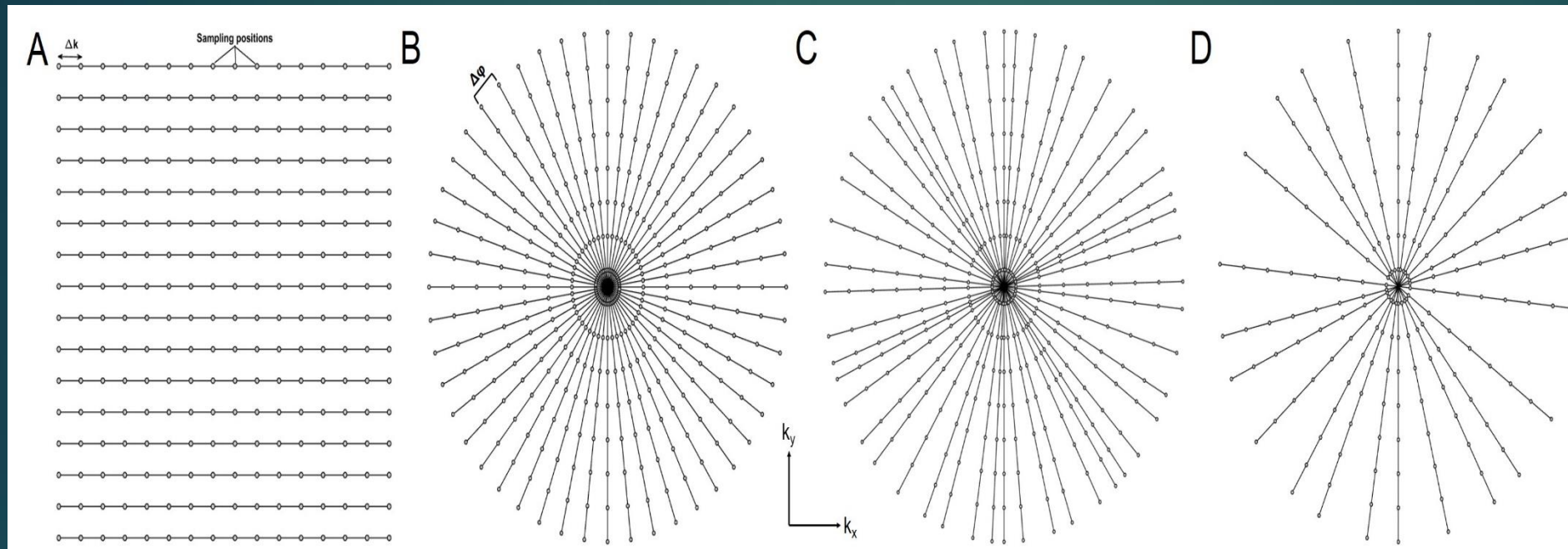

Sampling schemes using **(A)** Cartesian encoding; **(B)** radial encoding; **(C)** Golden angle radial projections successively incremented by  $111.25^\circ$ ,  $\Delta k = \text{FOV}$ . No of spokes,  $n_s = (\pi/2) * n$ , where  $n$  = base resolution, distance between spokes  $< \Delta k$ . **(D)** Undersampled radial acquisition (2X) compared to **(C)**.

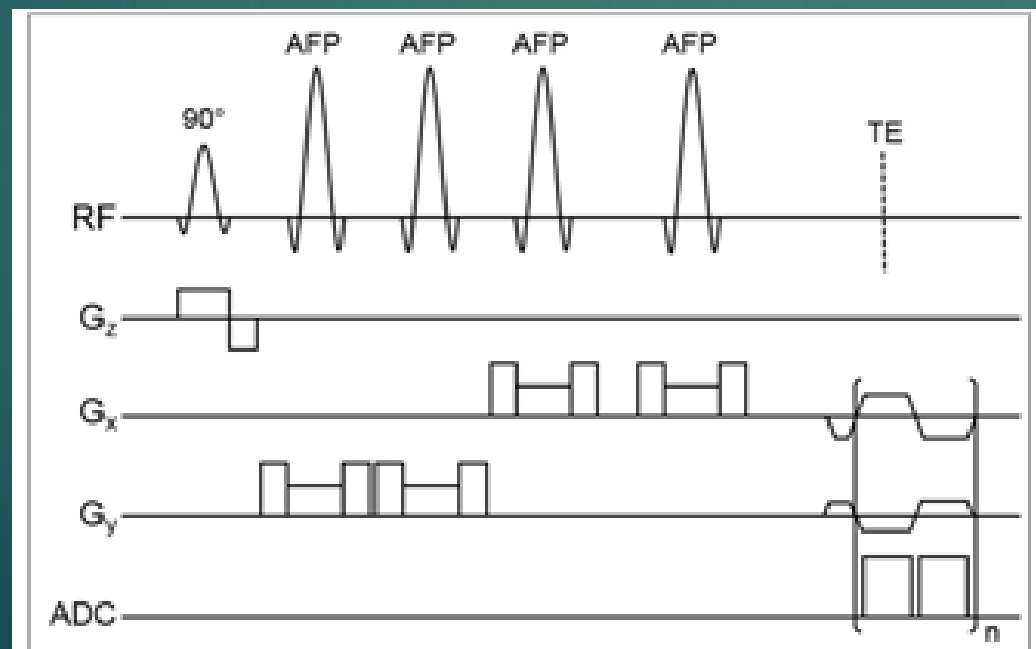

Saucedo, M. Sarma, MA Thomas  
ISMRM 2020  
MRM 2021



# Radial Spectroscopic Imaging

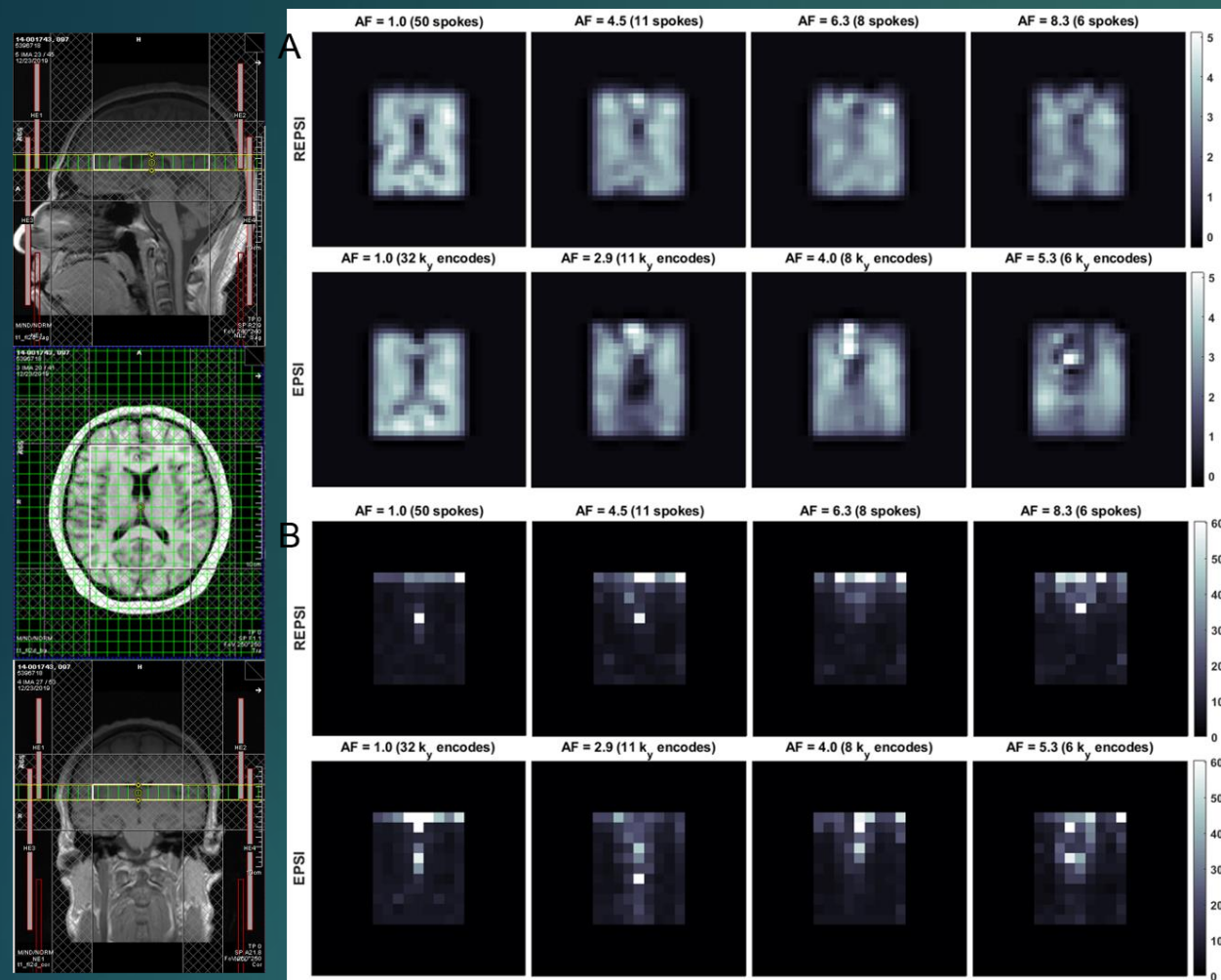

(Left) VOI localization in a 33 year-old healthy male volunteer. (A) tNAA maps from fully-sampled ( $AF = 1.0$ ) REPSI and EPSI brain data (leftmost column), and tNAA maps from CS reconstructions of prospectively undersampled brain data acquired with 11, 8, and 6 radial spokes or  $k_y$ -lines. These maps are interpolated by a factor of two. (B) CRLB maps for the tNAA maps shown in (A).

Representative and CS reconstructions of prospectively undersampled *in vivo* brain data from a 32 year-old healthy male volunteer. Spectra extracted : 1 – right putamen to corona radiata, 2 - occipital gray matter, 3 – left posterior insular cortex, and 4 – frontal white matter. Both the REPSI and EPSI data were prospectively undersampled with 11, 8, and 6 acquired radial spokes or  $k_y$ -lines, respectively.

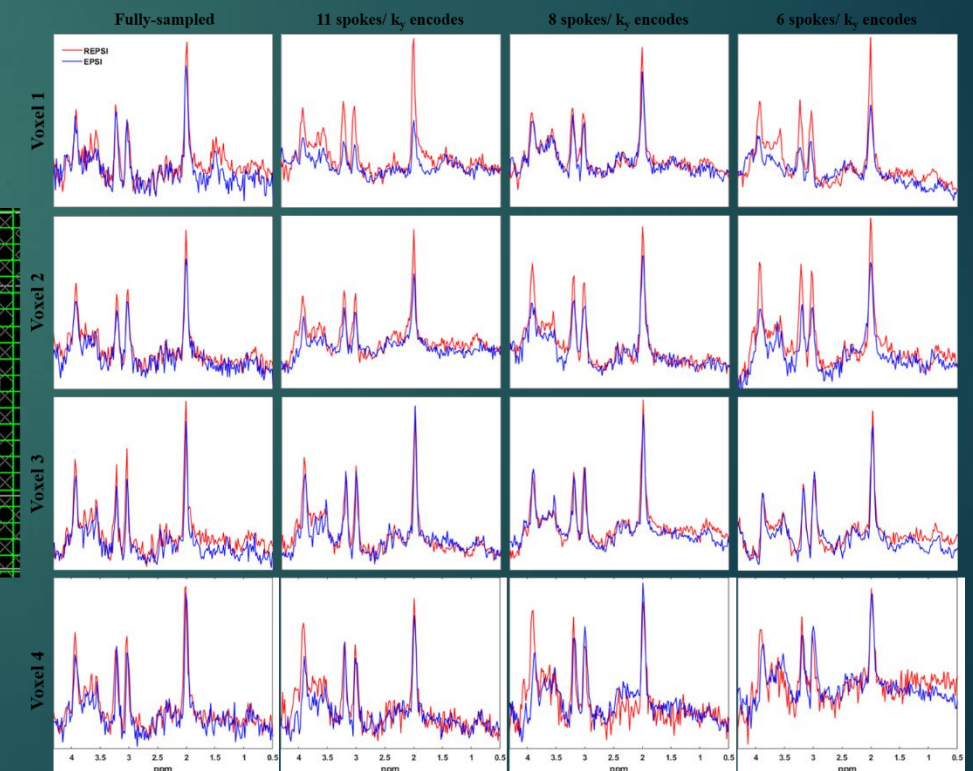
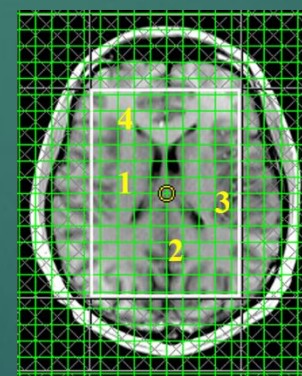



# Single-voxel localized 2D MRS : L-COSY and JPRESS

# 1D MRS Quantitation

- ▶ LC-Model for 1D MRS quantitation.
- ▶ Works in frequency domain using prior knowledge

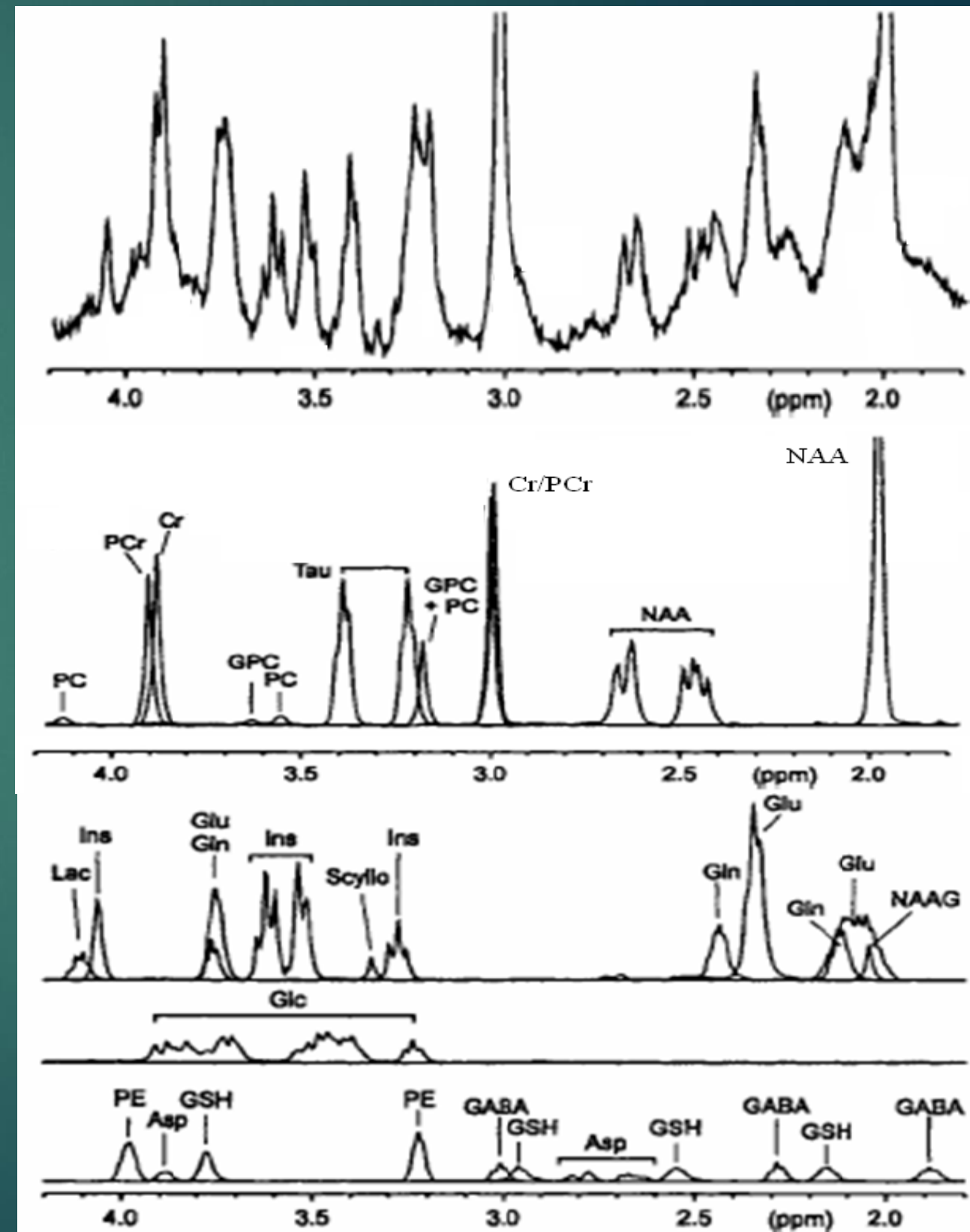

*Provencher (2001)*



# A quote from 1991 Nobel laureate Richard Ernst

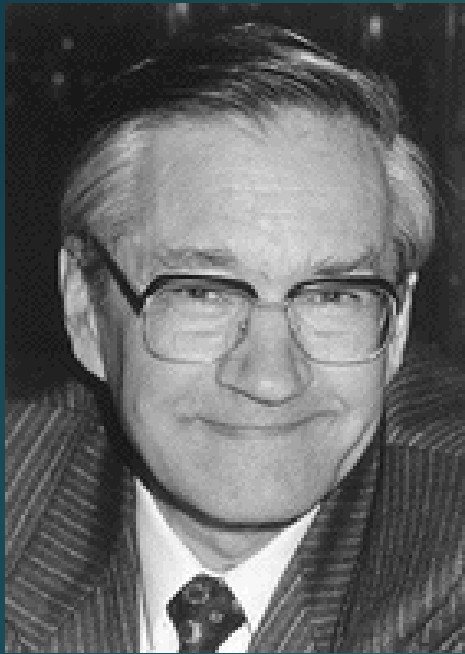

*“One-dimensional spectra that are rendered inscrutable because of severe overlap may be unravelled by separating interactions of different physical origins, e.g. chemical shift and couplings, thus making it possible to spread the signals in a second frequency dimension much like opening a Venetian blind.”*

# Why 2D Spectroscopy?

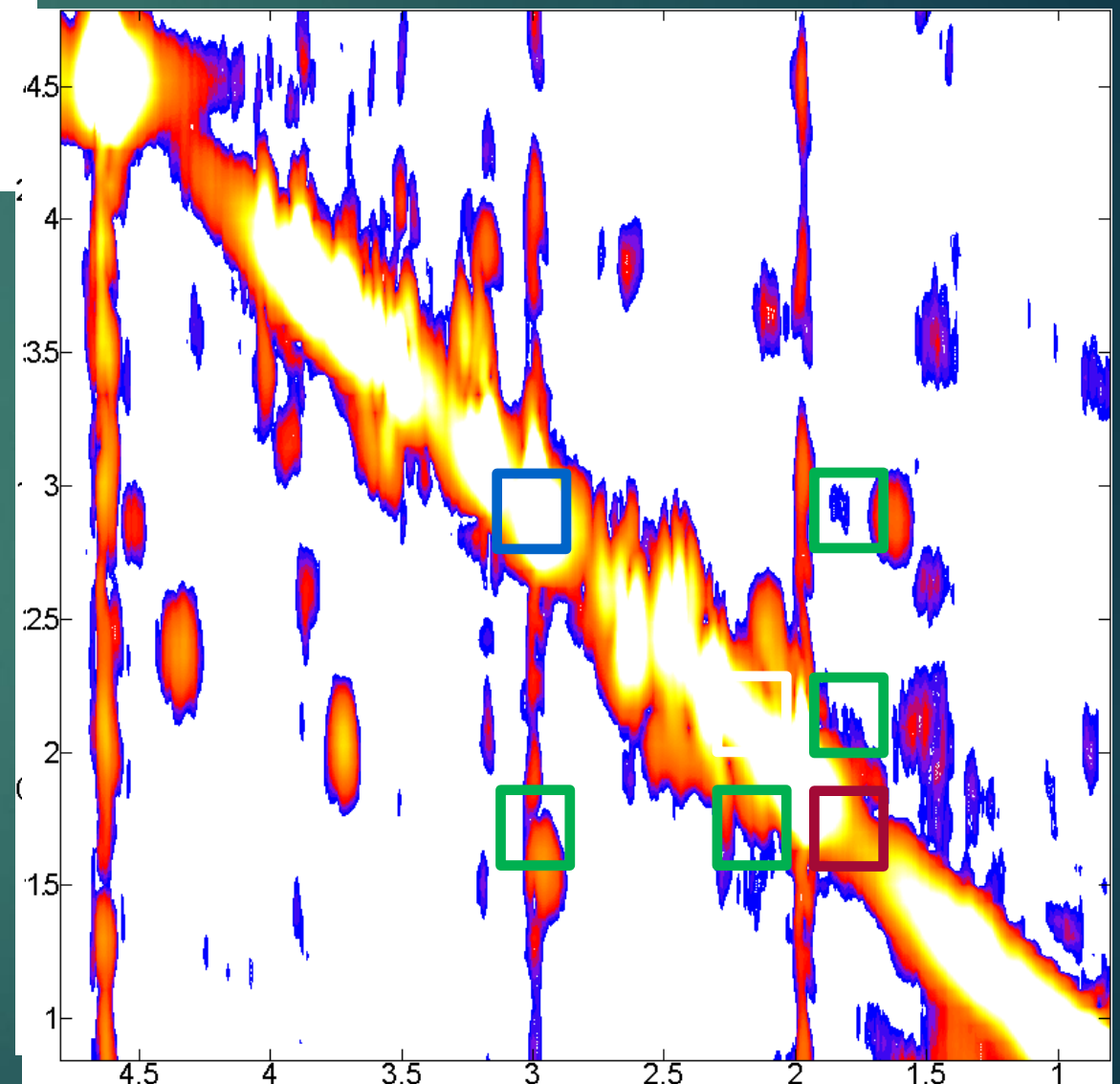
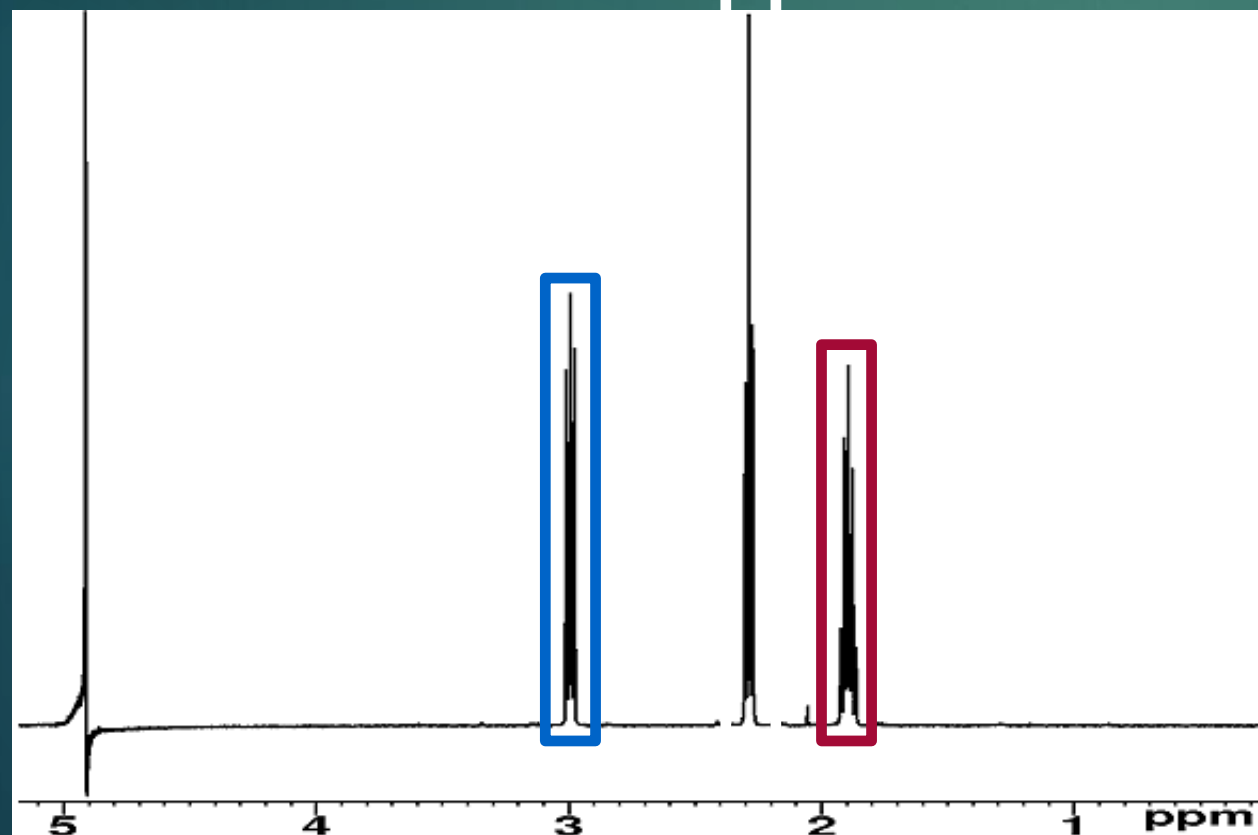
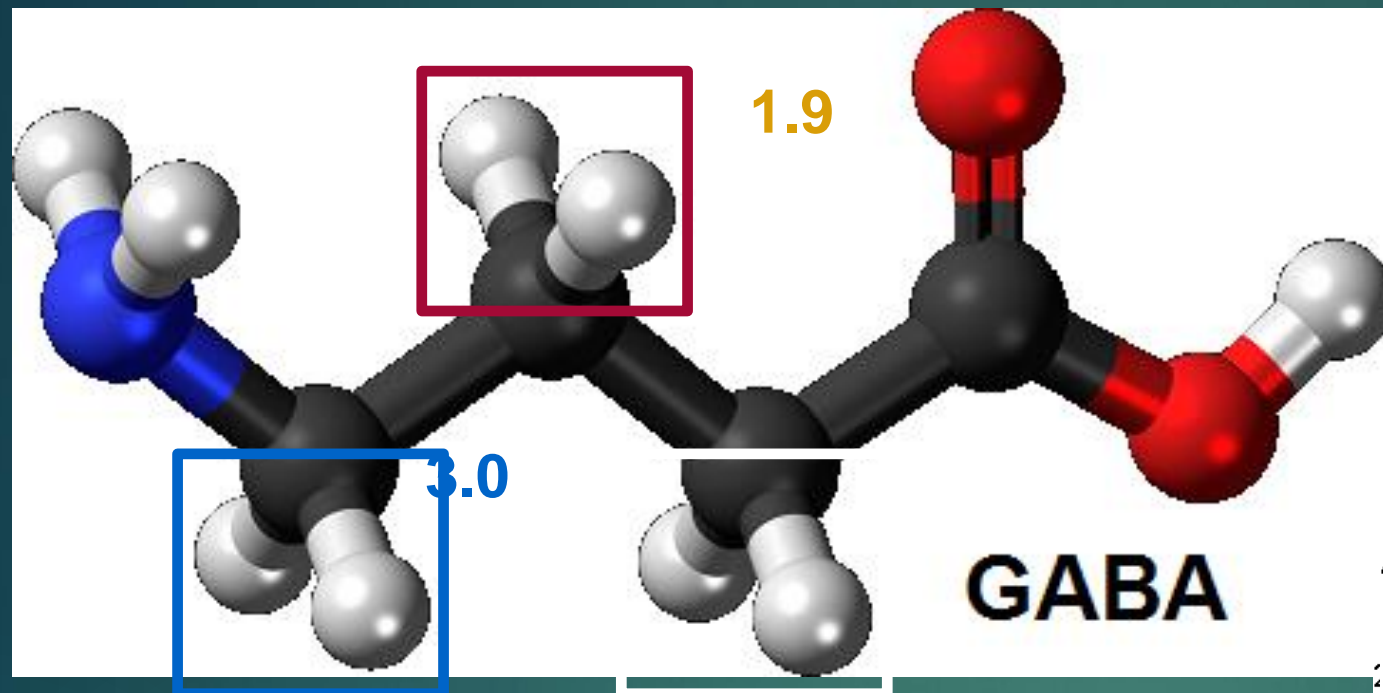



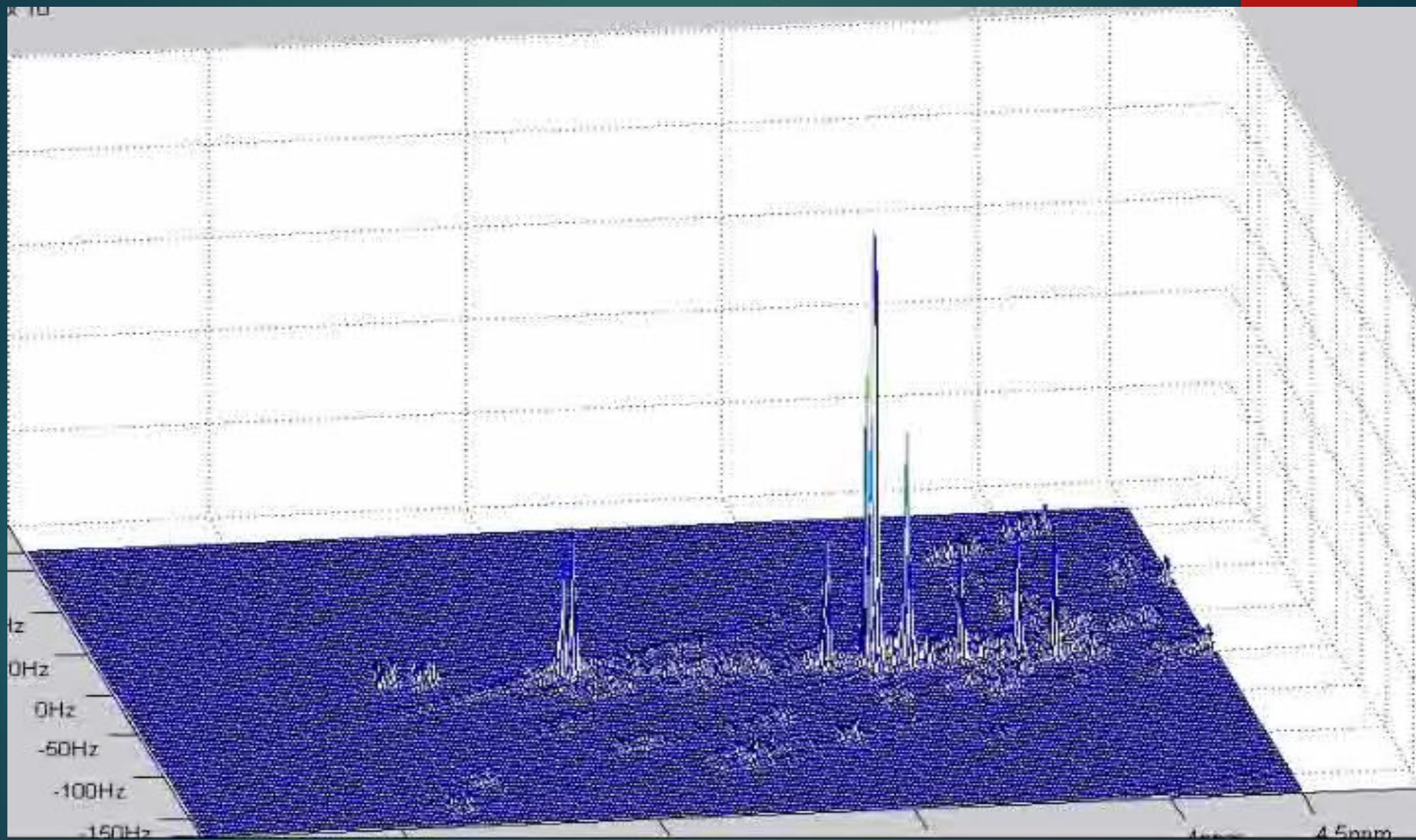



# Localized 2D Correlated Spectroscopy (L-COSY)

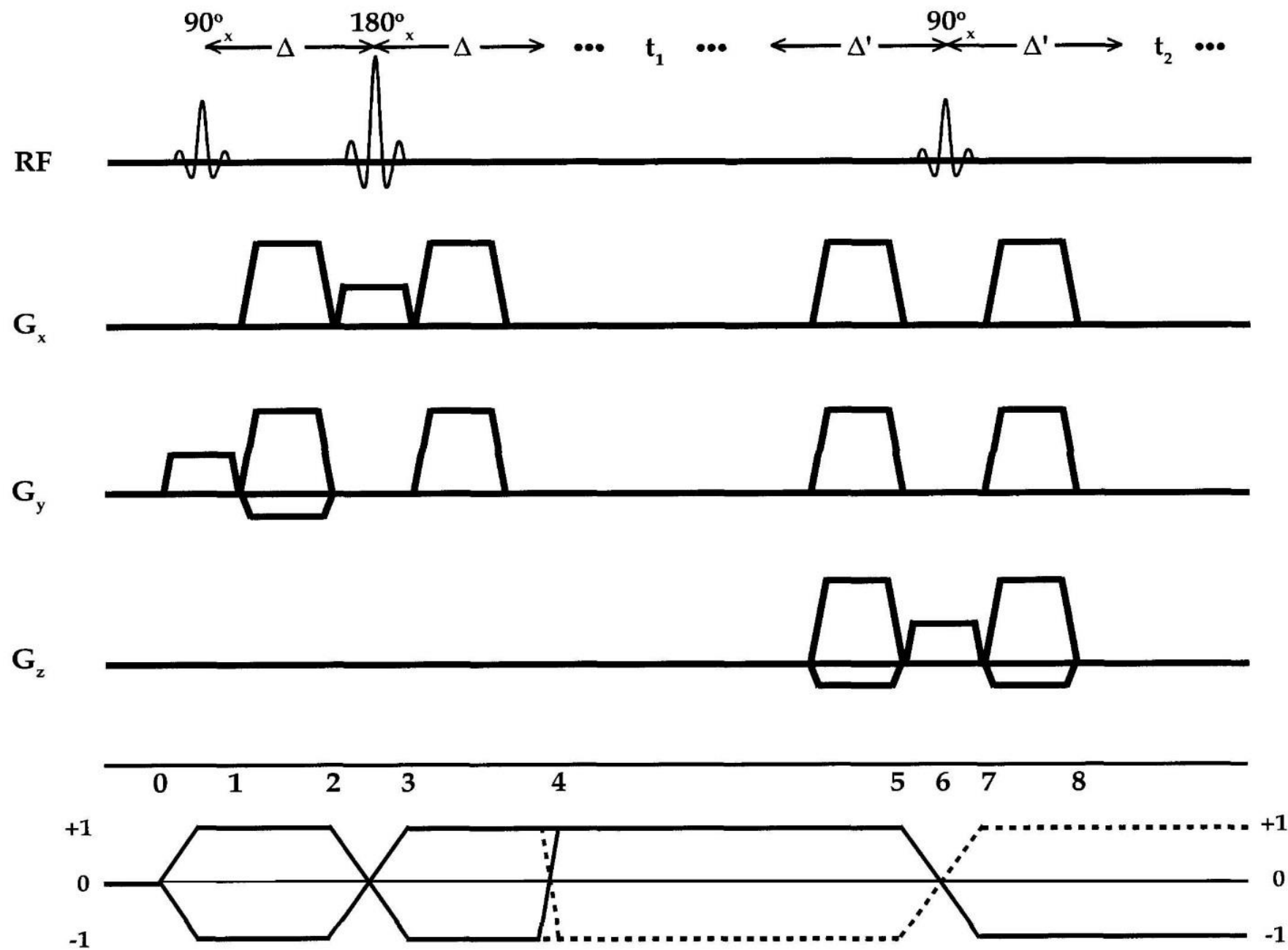

- Based on a spin-echo and a coherence-transfer-echo

Hahn (1952) / Maudsley, Wokaun and Ernst (1978)

Thomas et al. (MRM2001)



F1

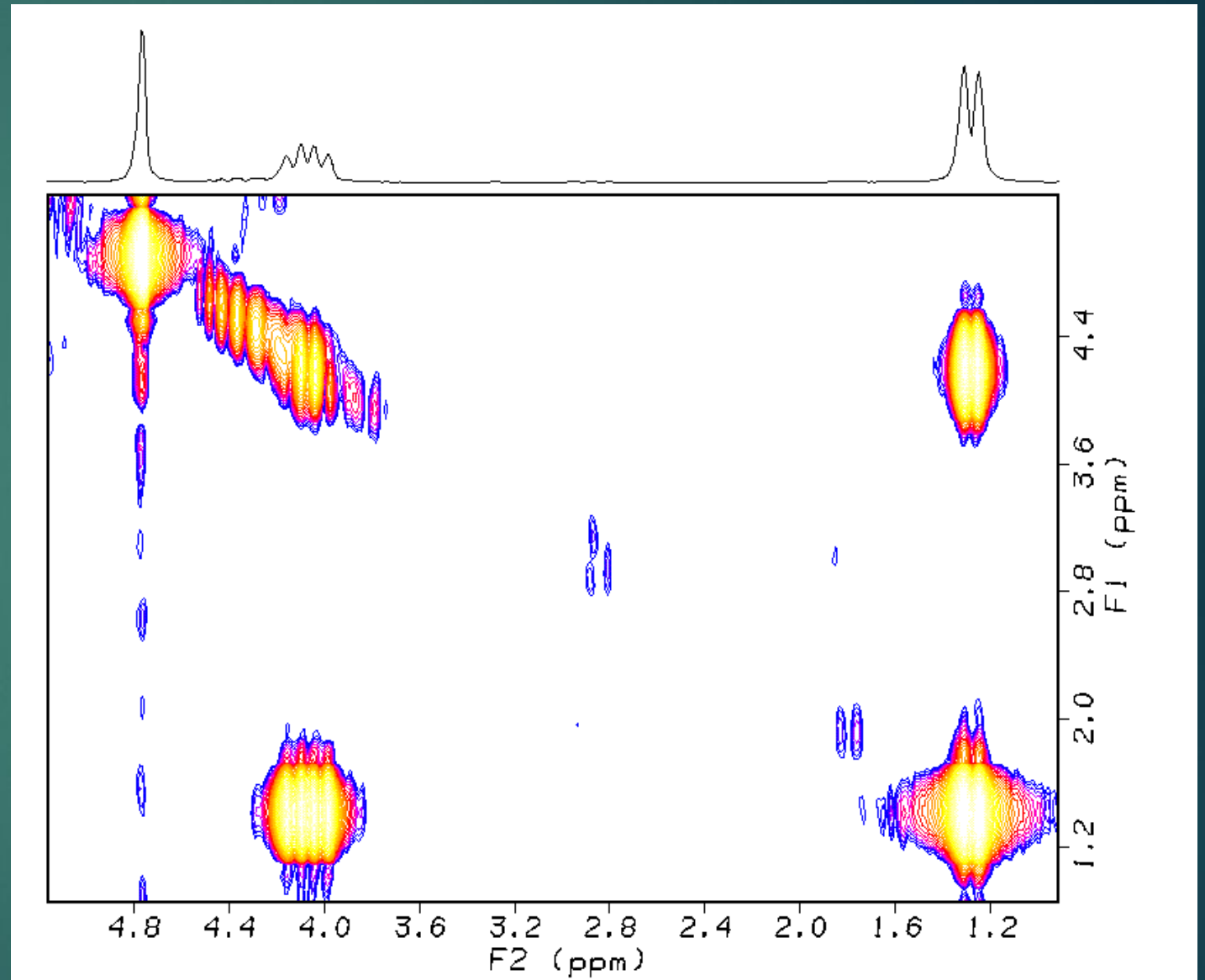
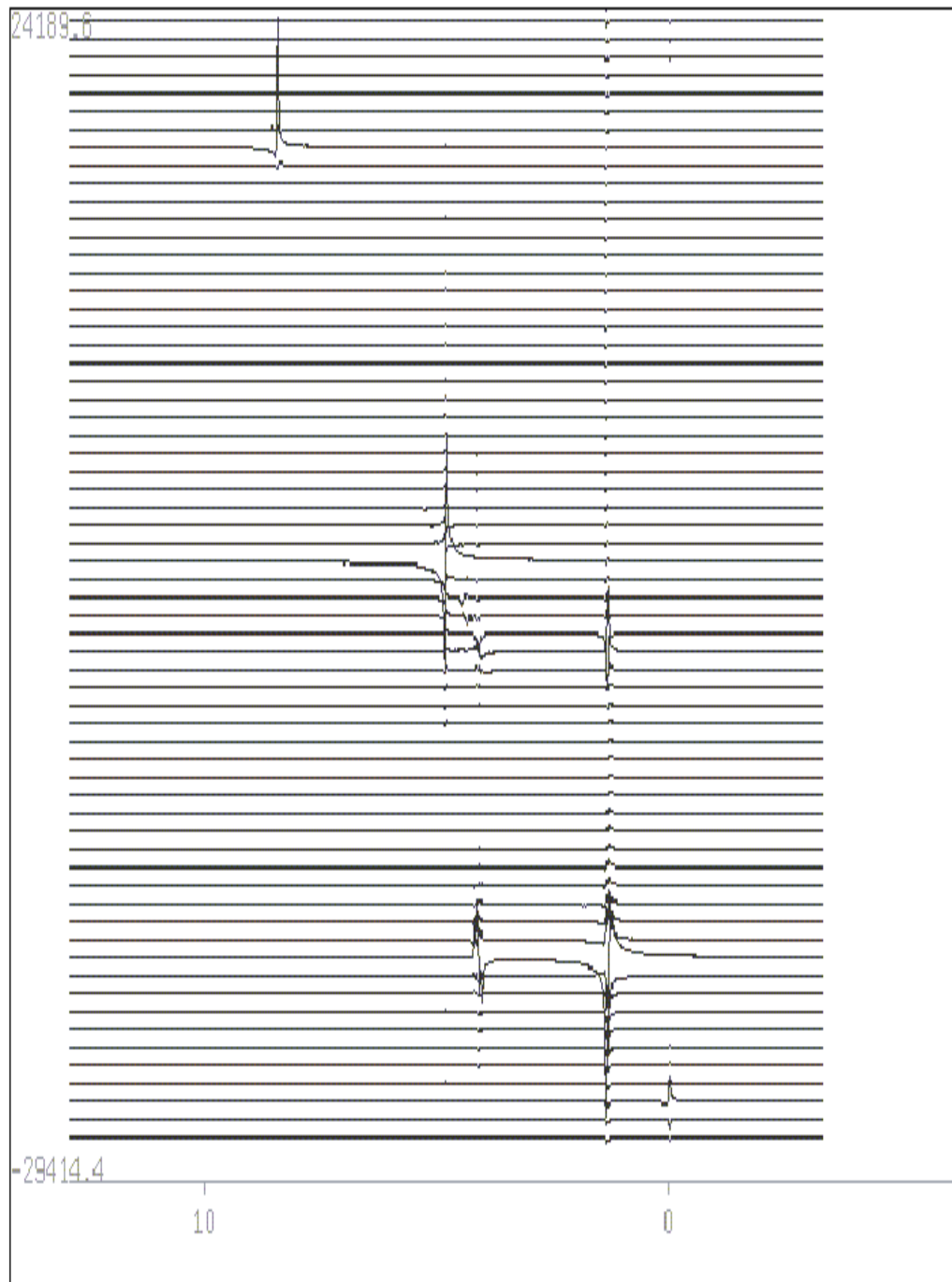

F2

# Brain Phantom 3T MRI/MRS Scanner

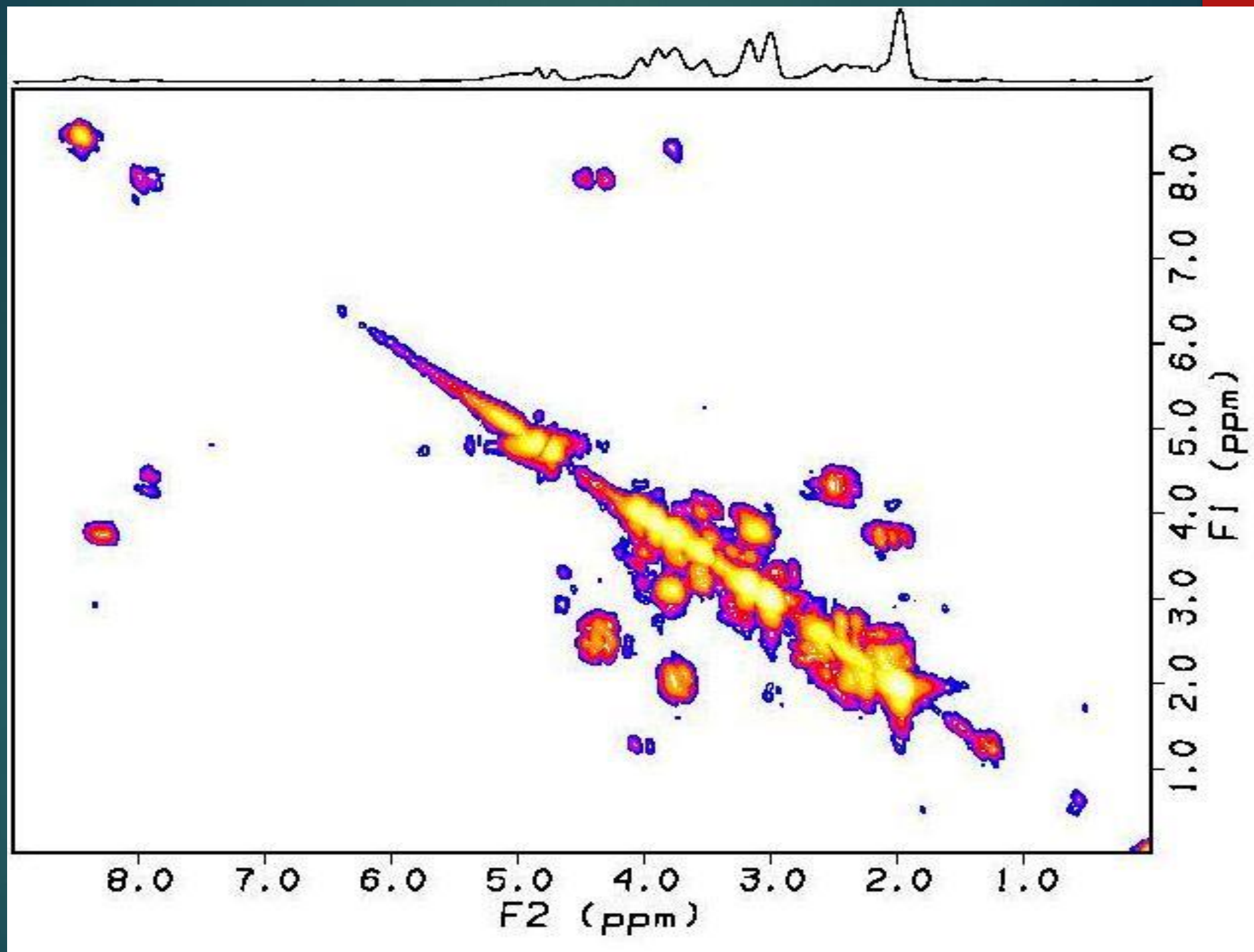



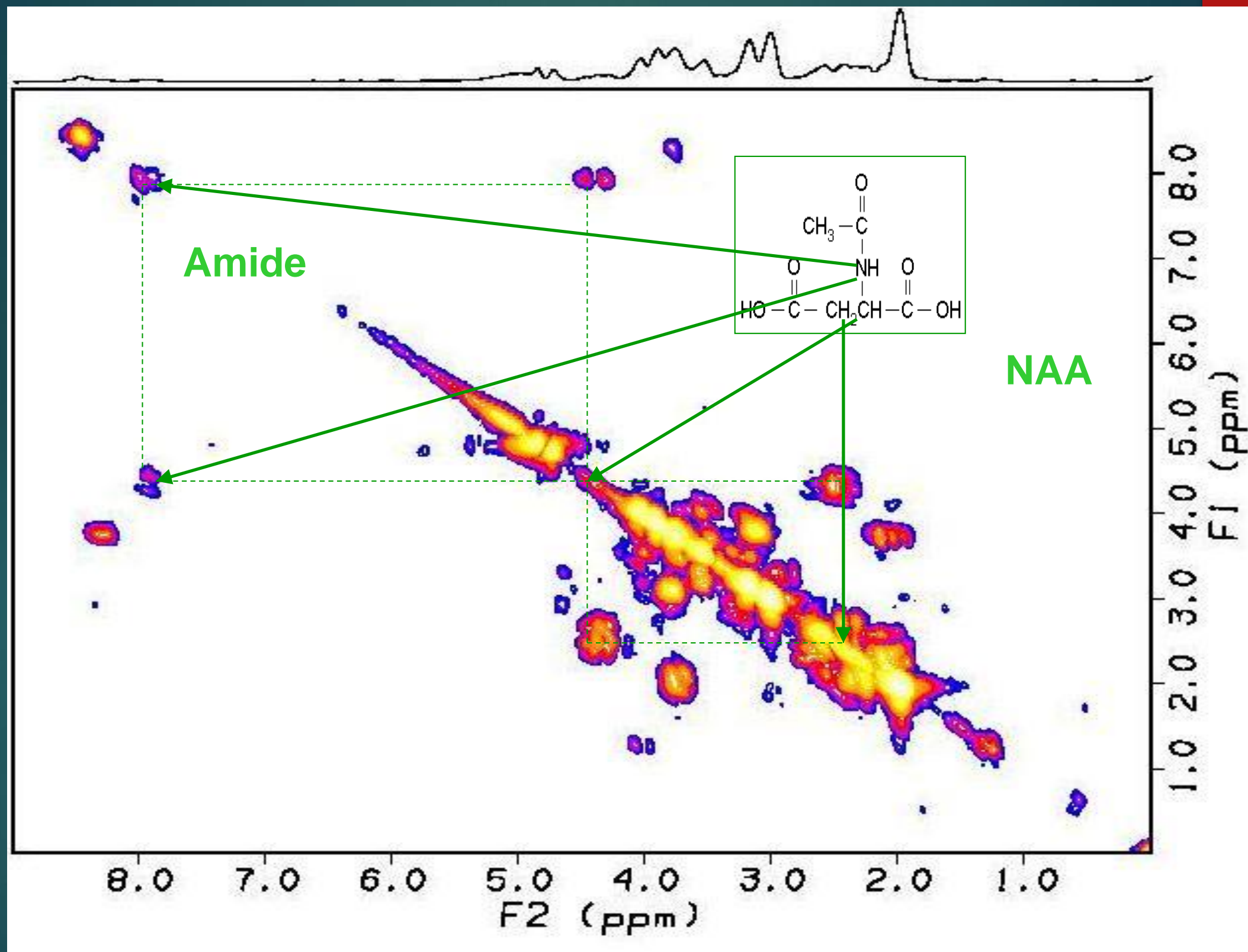

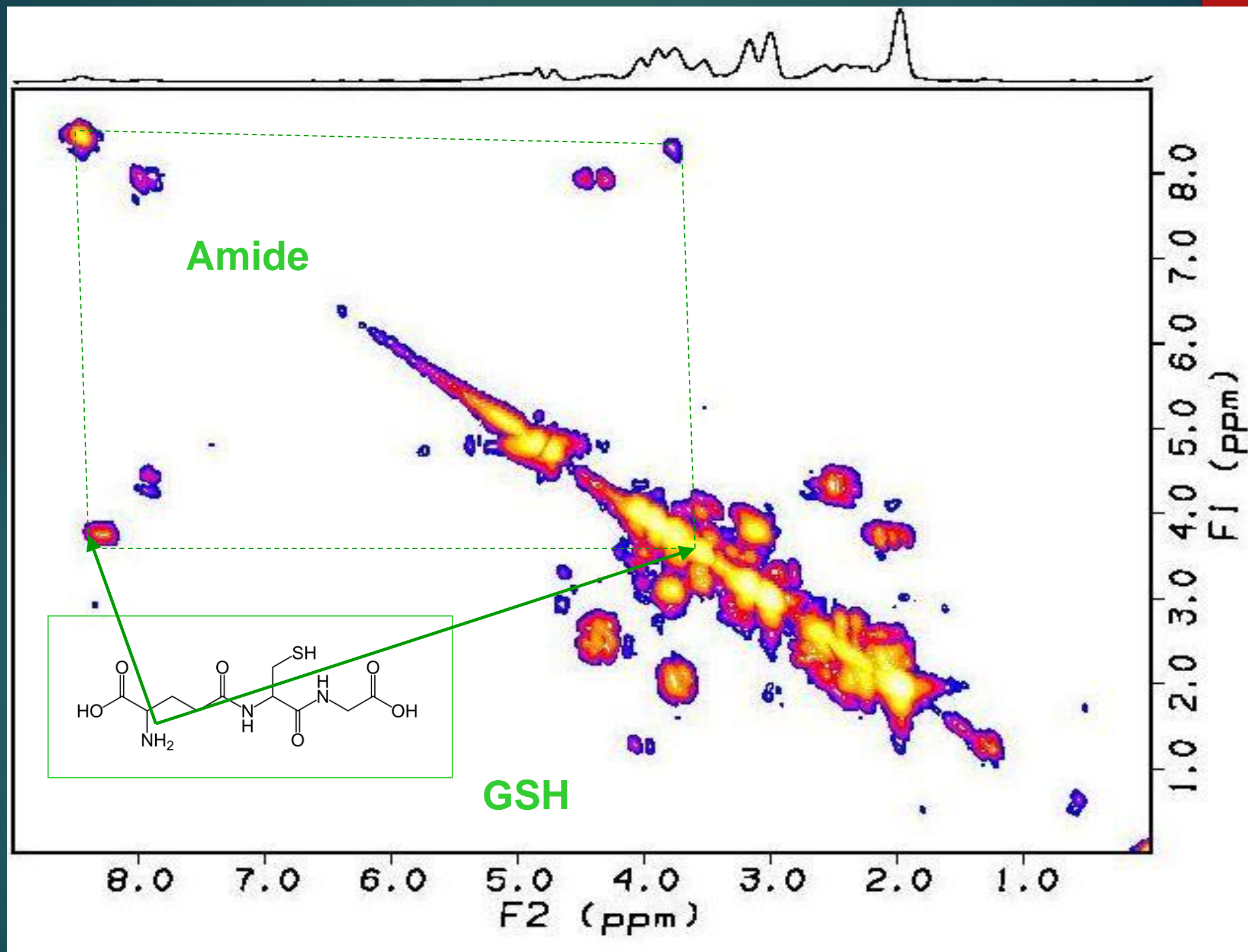

# 2D MRS – Gray Matter Metabolites

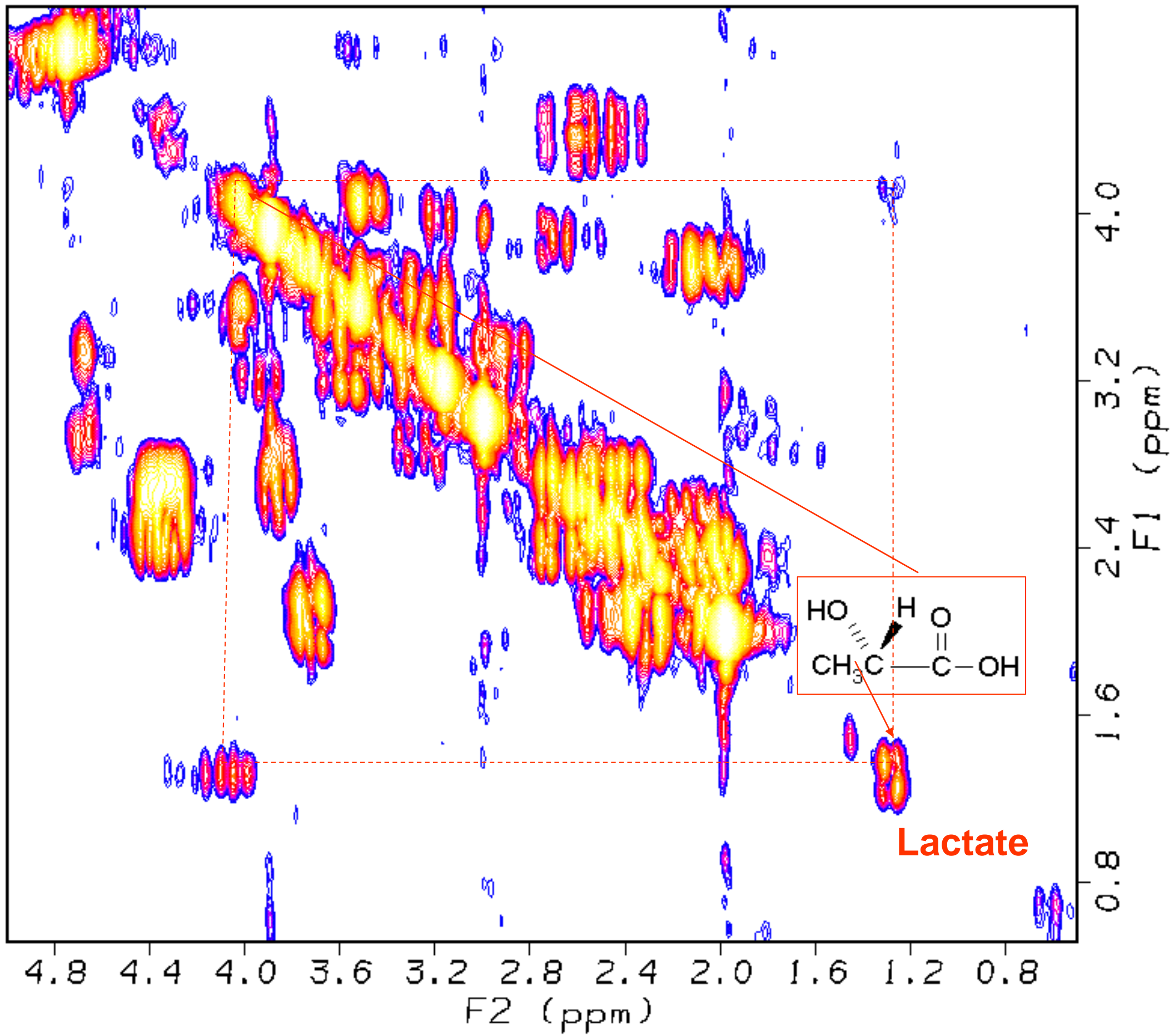



# 2D MRS – Gray Matter Metabolites

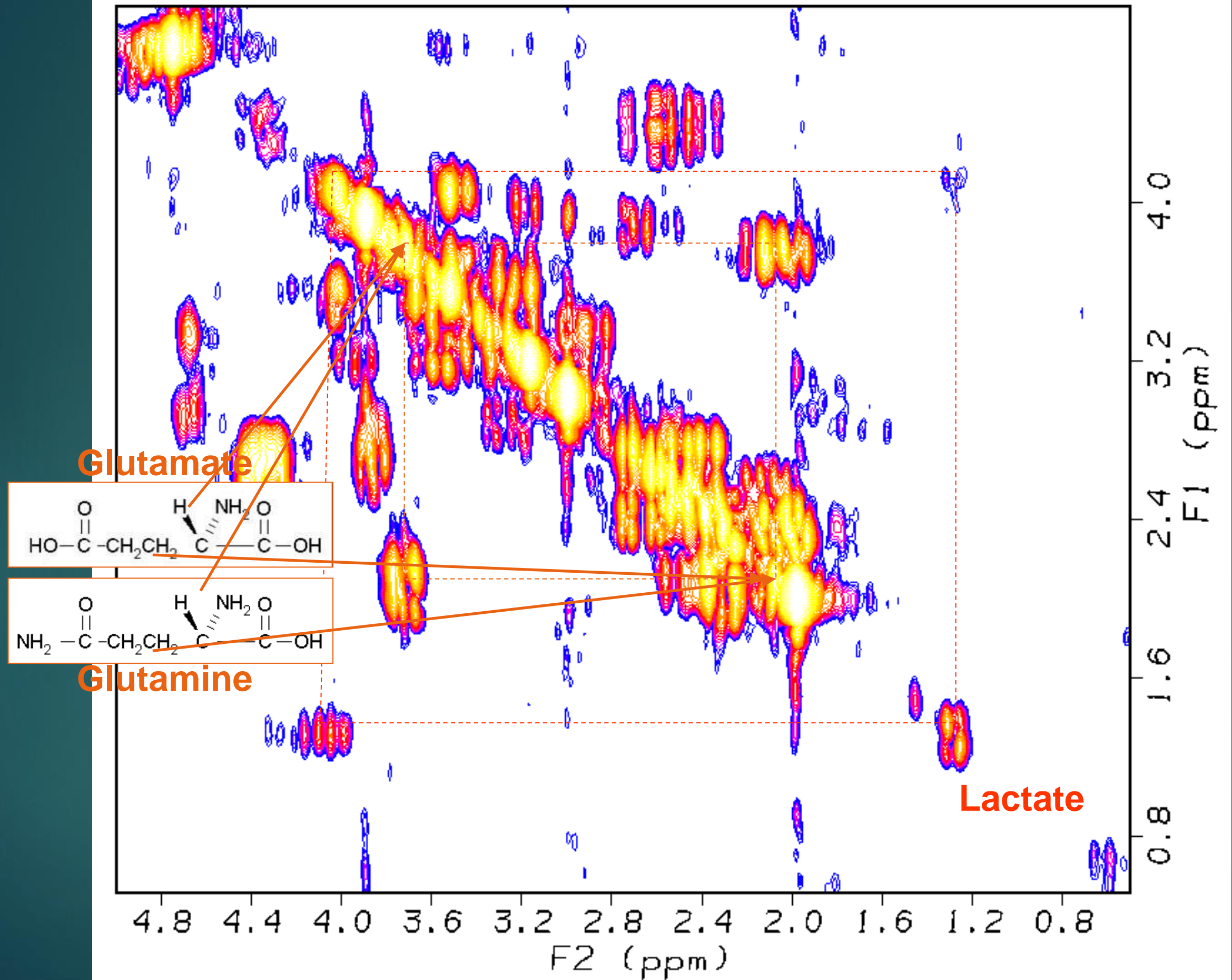

# Localized 2D COSY Spectra of a 27yo healthy breast

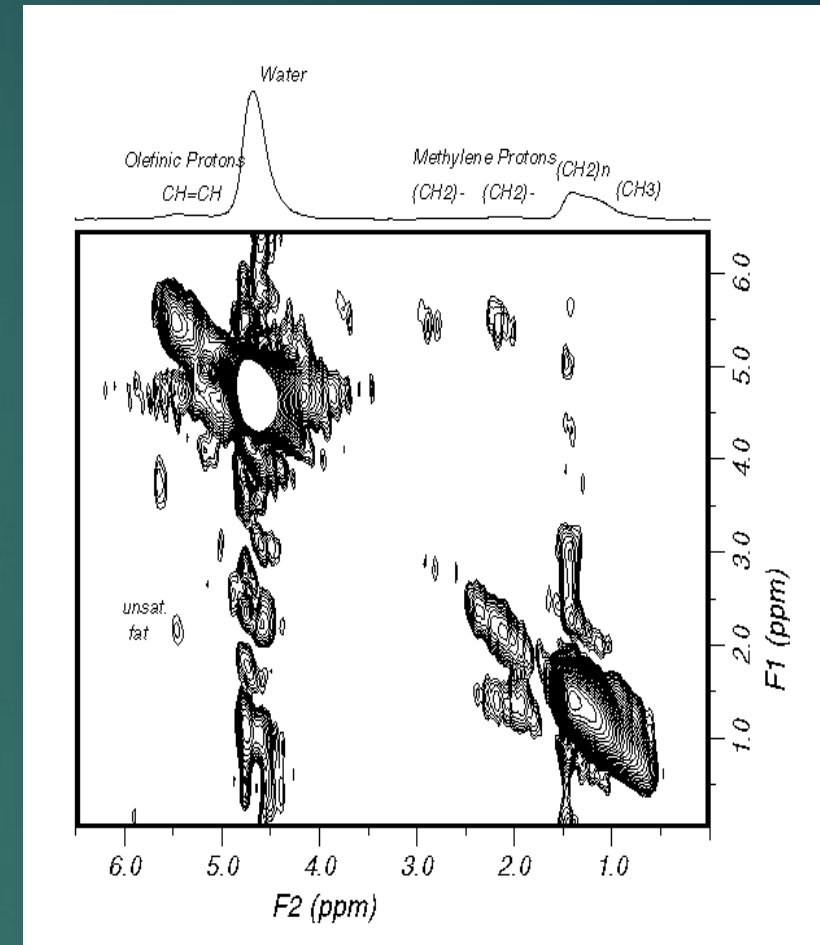
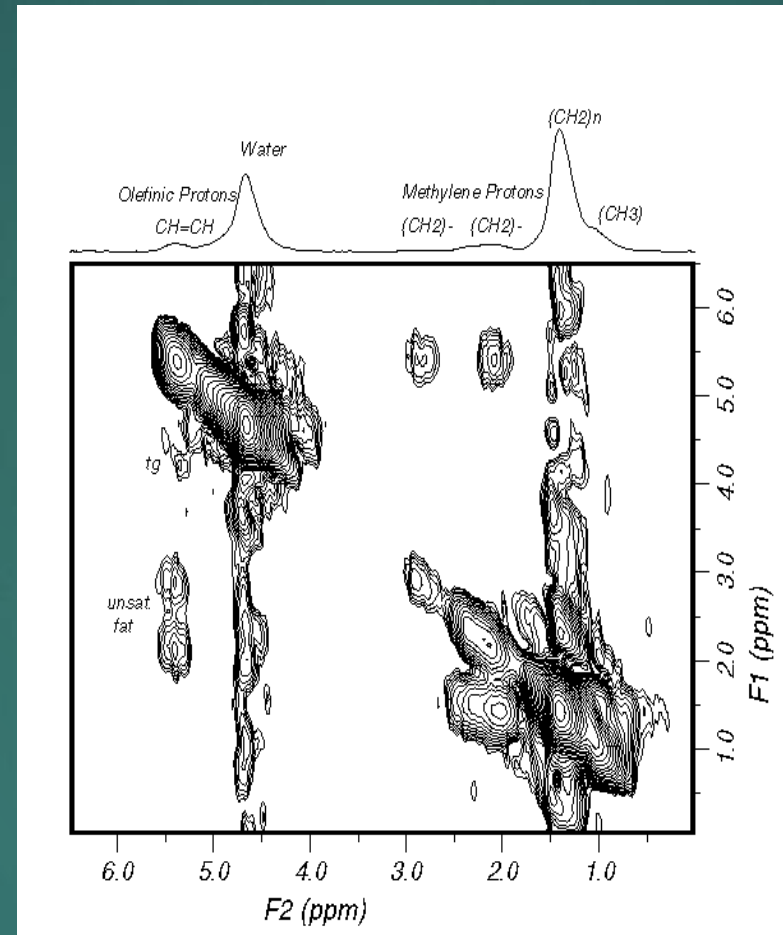
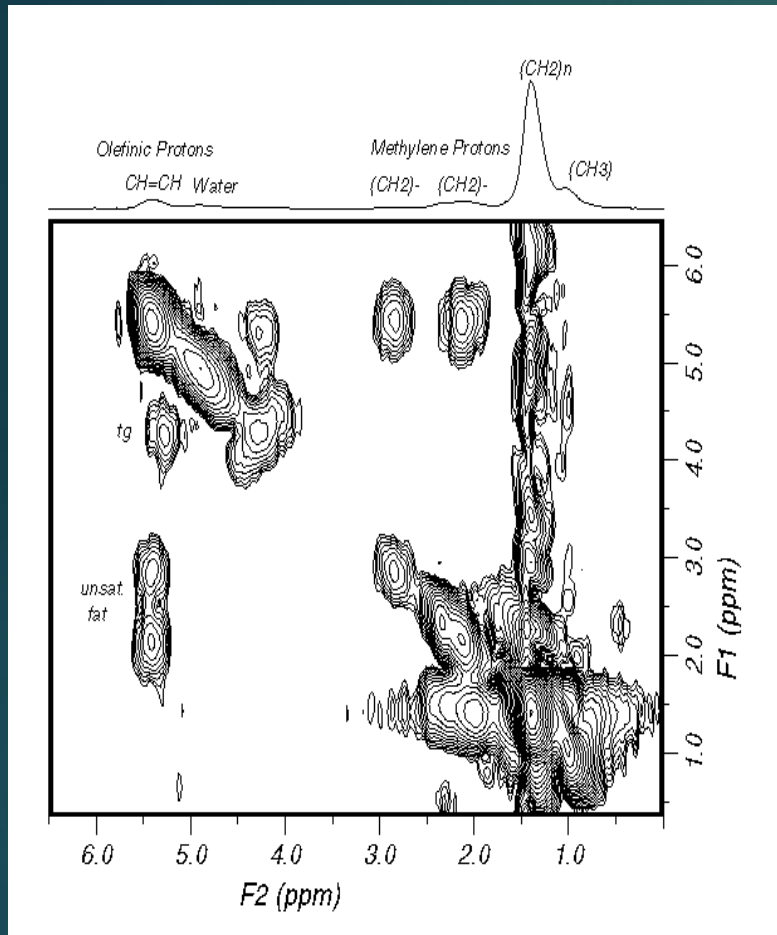

- $1 \times 1 \times 1 \text{ cm}^3$
- $40 t_1$  incr.
- $8 \text{NEX} / \Delta t_1$
- $\sim 10$  minutes
- $1.5 \text{T}$
- $\sim 30$  minutes for 3 locations

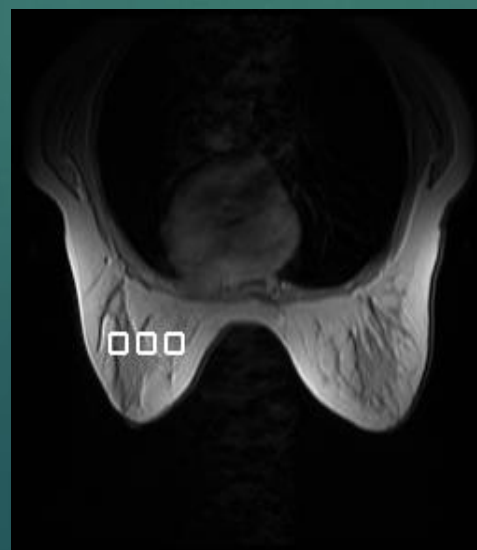

(Thomas JMIRI2001)

# DCE-MRI

- ▶ Graphs of DCE-MRI curves for malignant patients
- ▶ Plots show uncertainty in enhancement curves
- ▶ Patient I shows a plateau shaped curve which cannot differentiate malignant from benign lesion

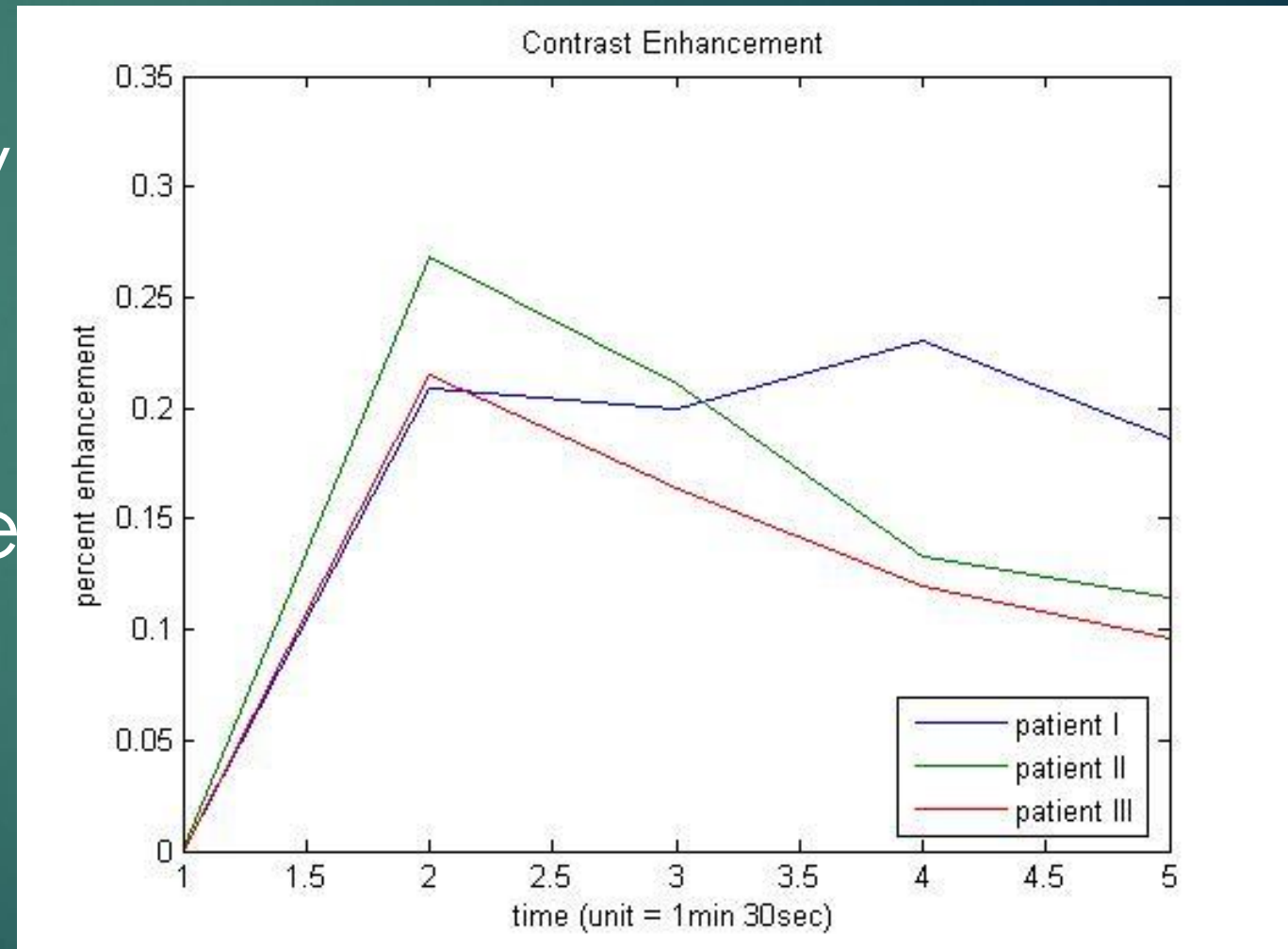



# Malignant Patient with Type II enhancement

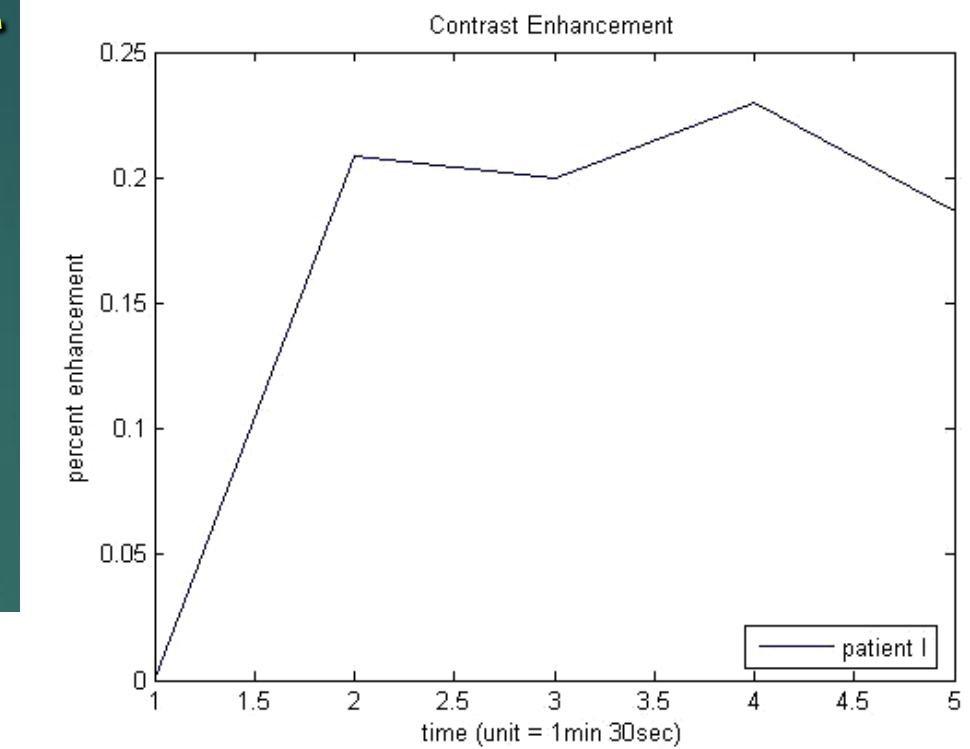
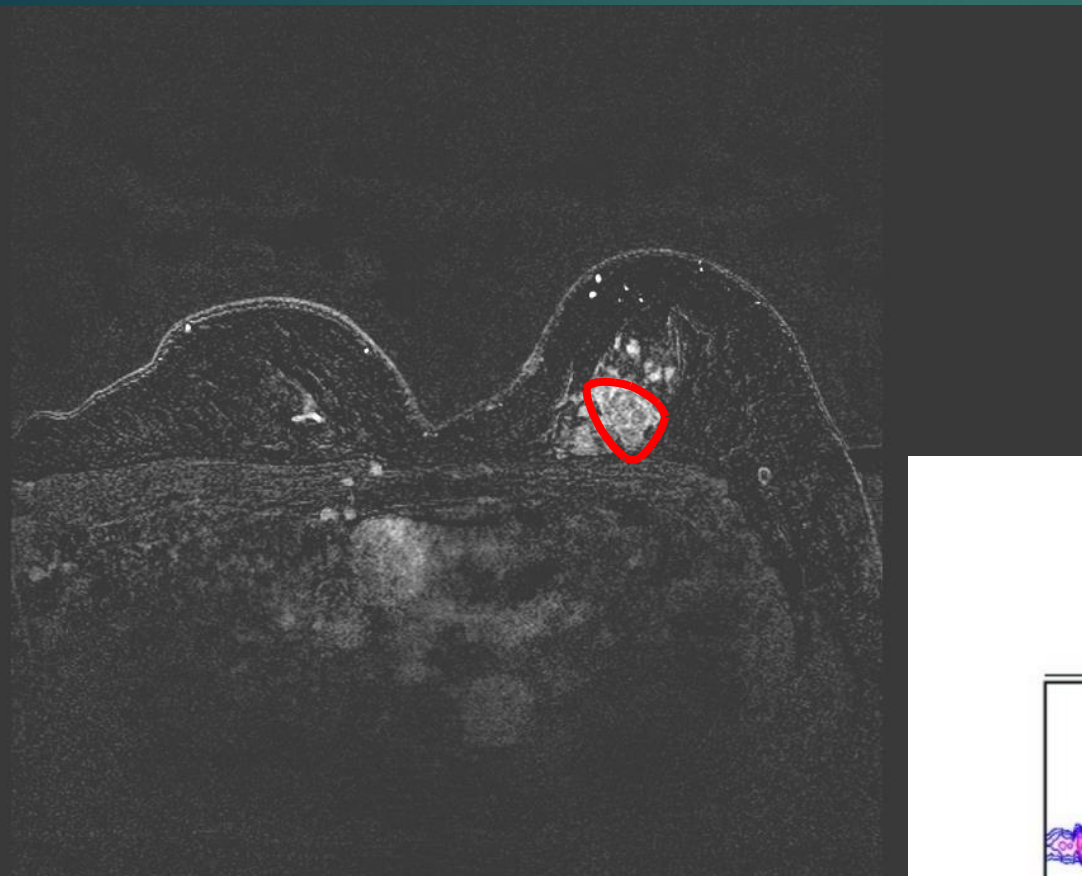

-56 yo malignant patient  
-1x1x1 cm<sup>3</sup>  
-45 t1 incr.  
-8NEX/  $\Delta$  t1  
-12 minutes

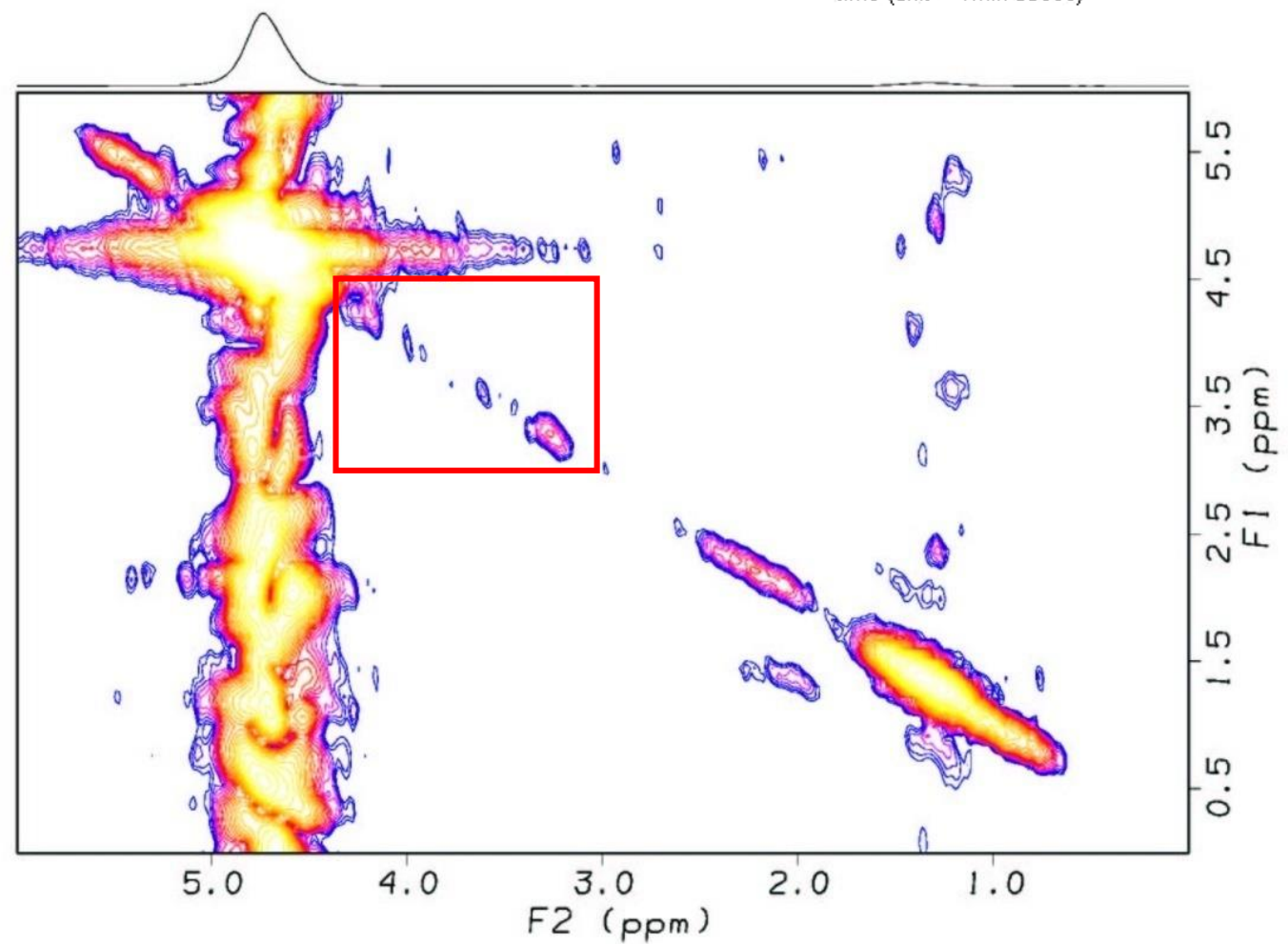

# 2D L-COSY of Breast Cancer

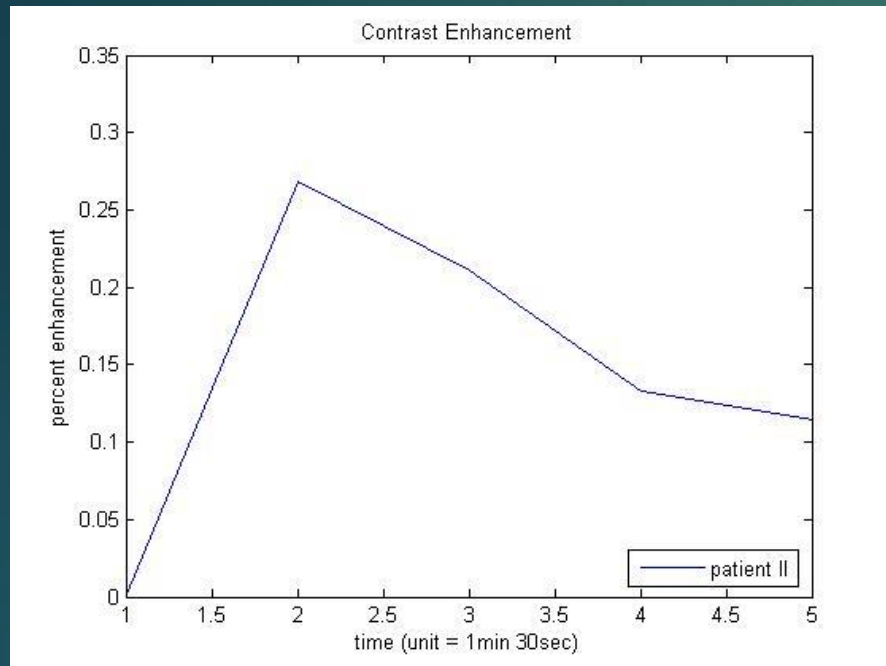

A 55 yo malignant patient

- 1x1x1 cm<sup>3</sup>
- 45 t<sub>1</sub> incr.
- 8NEX/ Δ t<sub>1</sub>
- 12 minutes

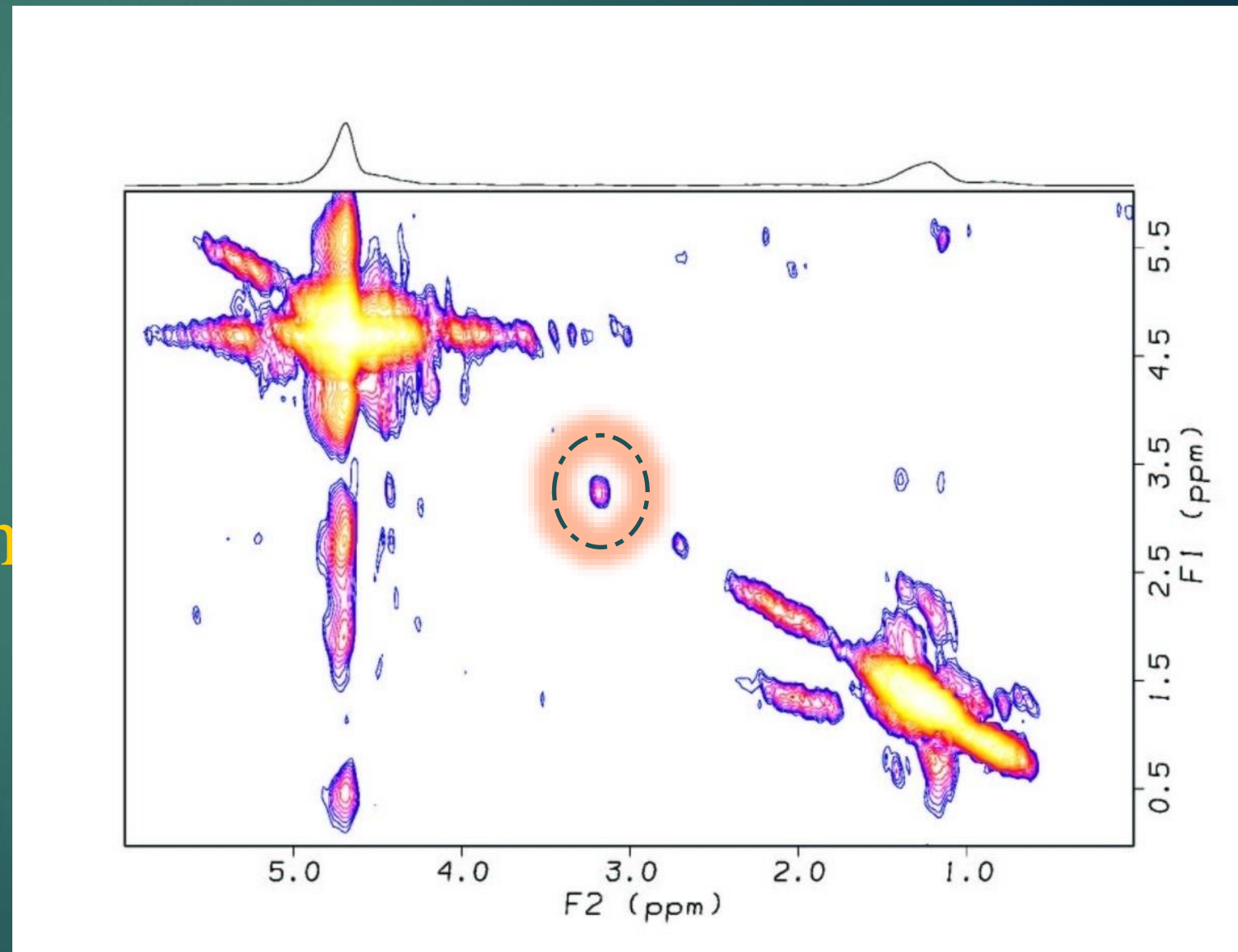

Lipnick 2010

# 2D L-COSY of Breast Cancer

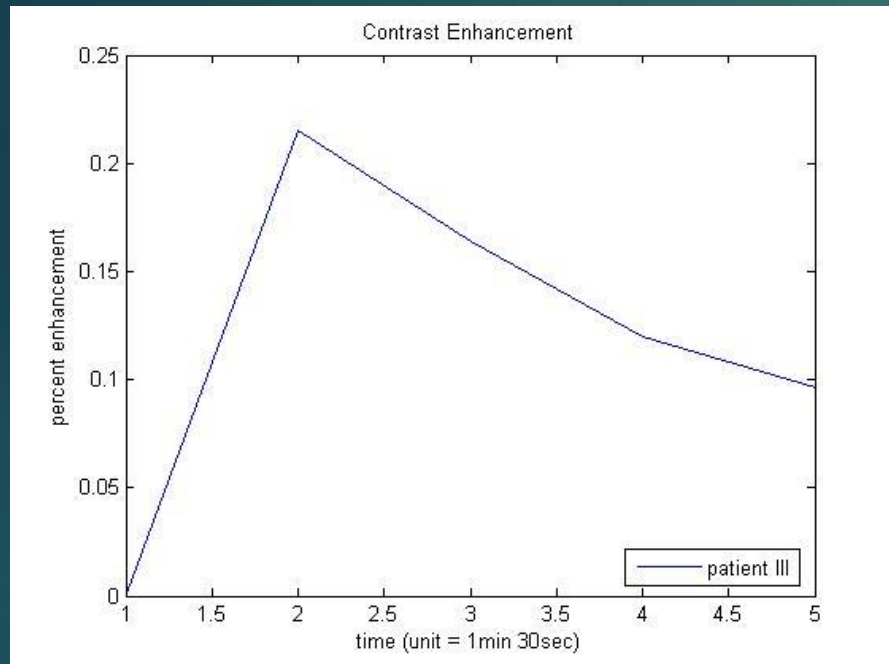

A 55 yo malignant patient

- 1x1x1 cm<sup>3</sup>
- 45 t<sub>1</sub> incr.
- 8NEX/ Δ t<sub>1</sub>
- 12 minutes

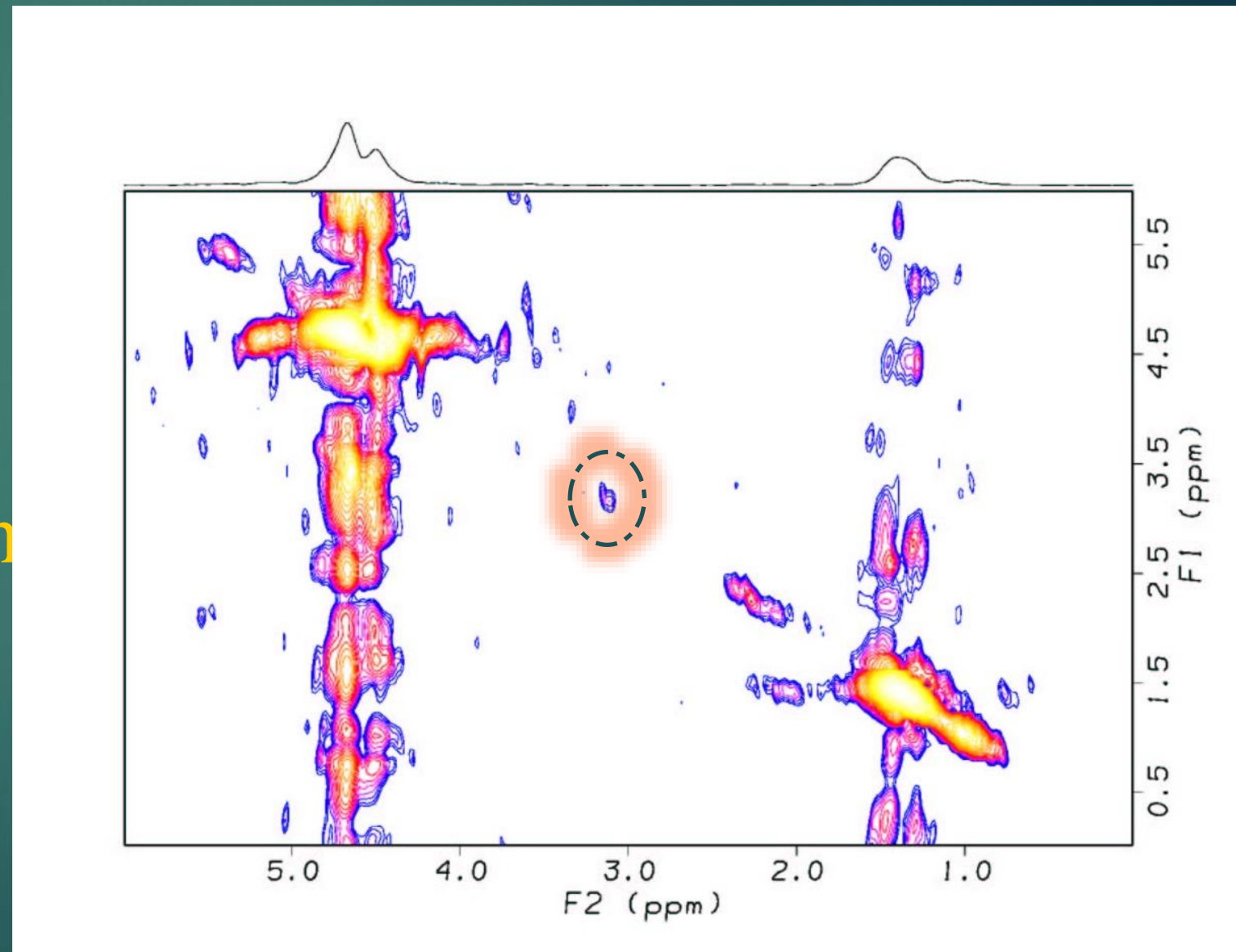





# 4D $^1\text{H}$ MR Spectroscopic Imaging: 2 Spectral + 2 Spatial Dimensions

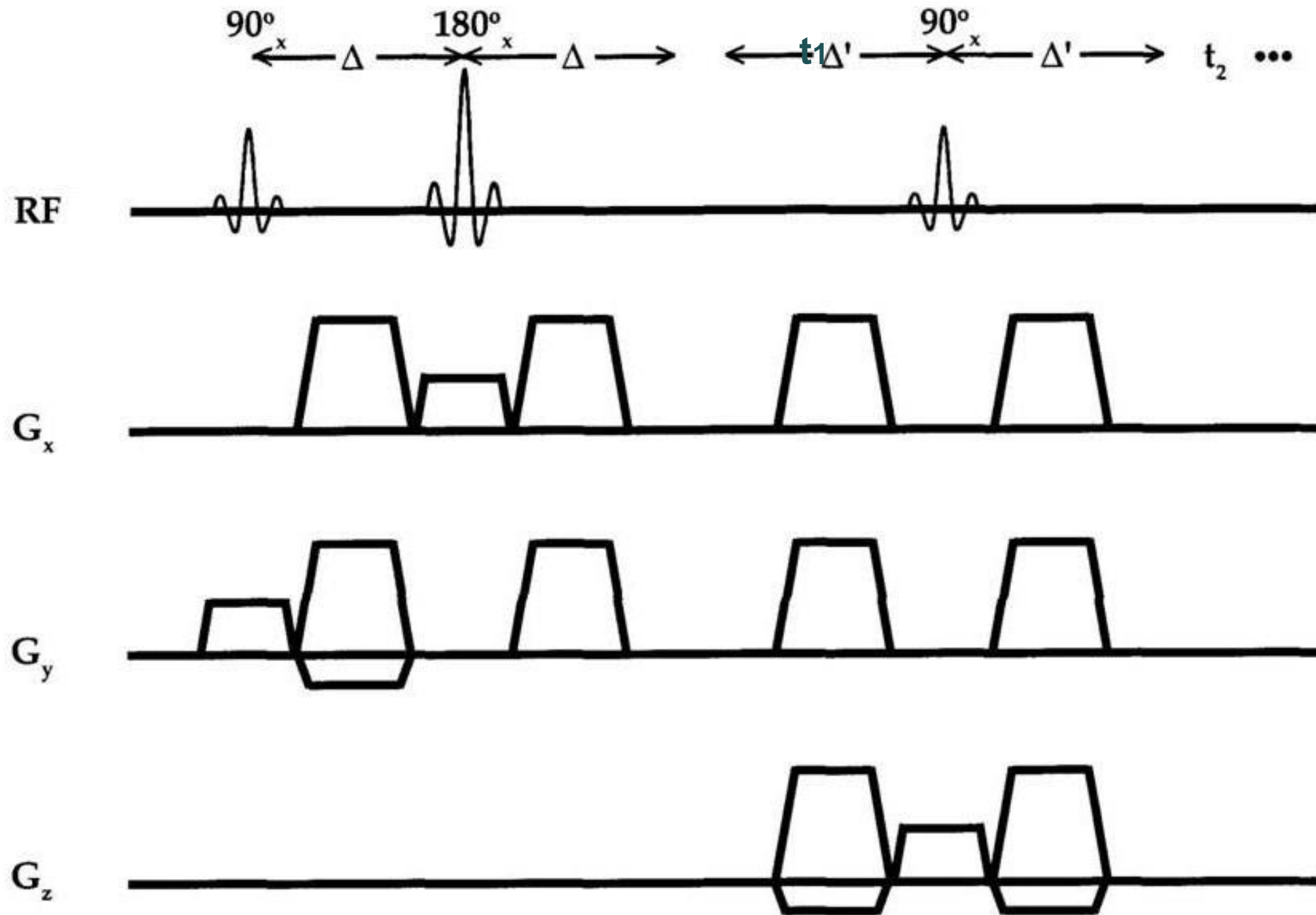

Total Scan time  
 $TR * N_{(t_1 \text{ Encodings})} * \text{Averages}$

$= 2s * 128 * 8 = 34 \text{ minutes}$

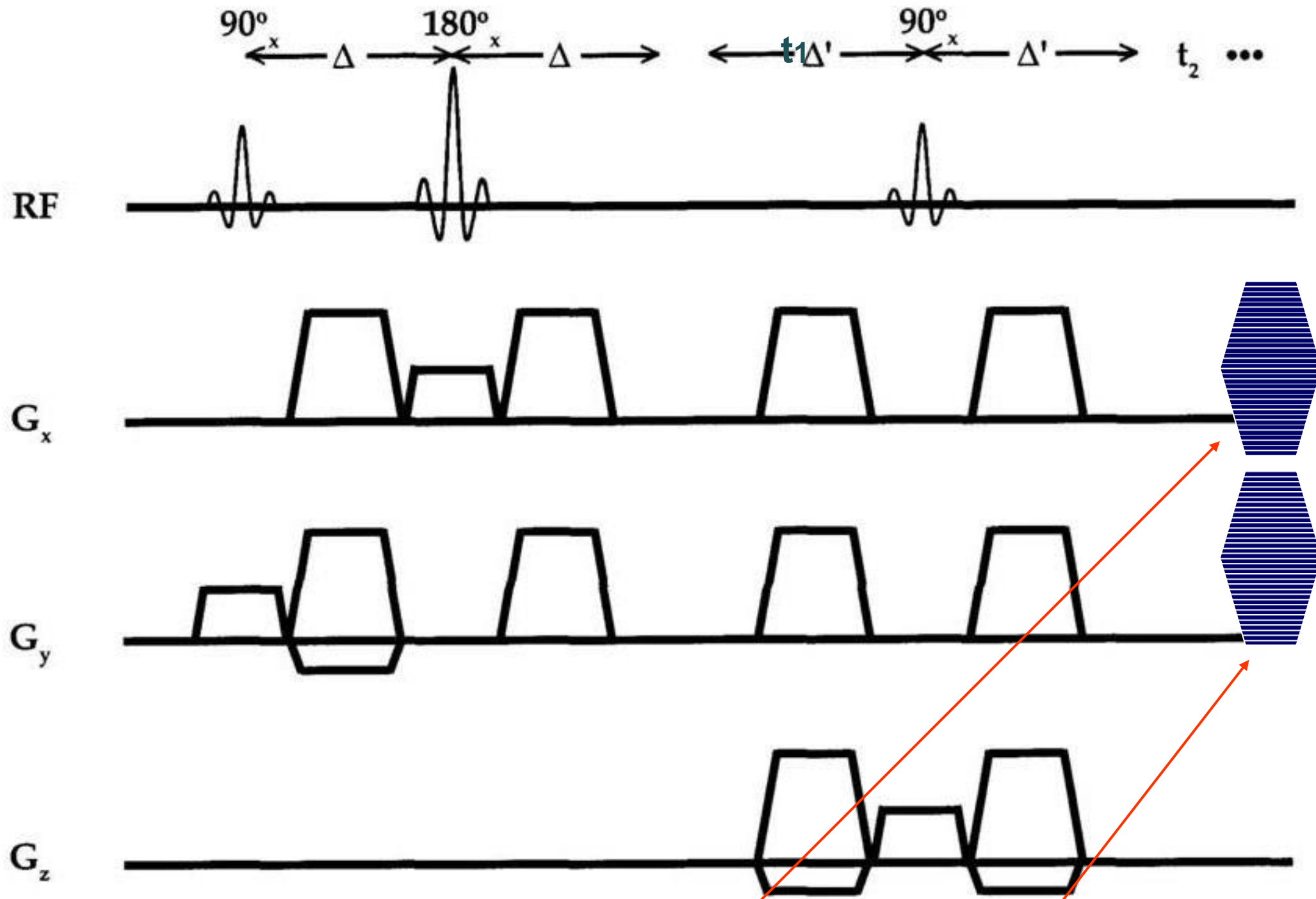

$$\begin{aligned}
 &= 2s * 128 * 1 * 16 * 1 \\
 &\quad 6 \\
 &= 546 \text{ minutes} \\
 &\quad \text{Or} \\
 &= 2s * 128 * 1 * 16 \\
 &= 18.2 \text{ hours}
 \end{aligned}$$

Total Scan time

$$\text{TR} * N_{(t_1 \text{ Encodings})} * N_{(y\text{-Phase Encodings})} * N_{(x\text{-Phase Encodings})} * N_{(t_1 \text{ Encodings})} * \text{Averages}$$



# Echo-Planar Correlated Spectroscopic Imaging (EP-COSY)

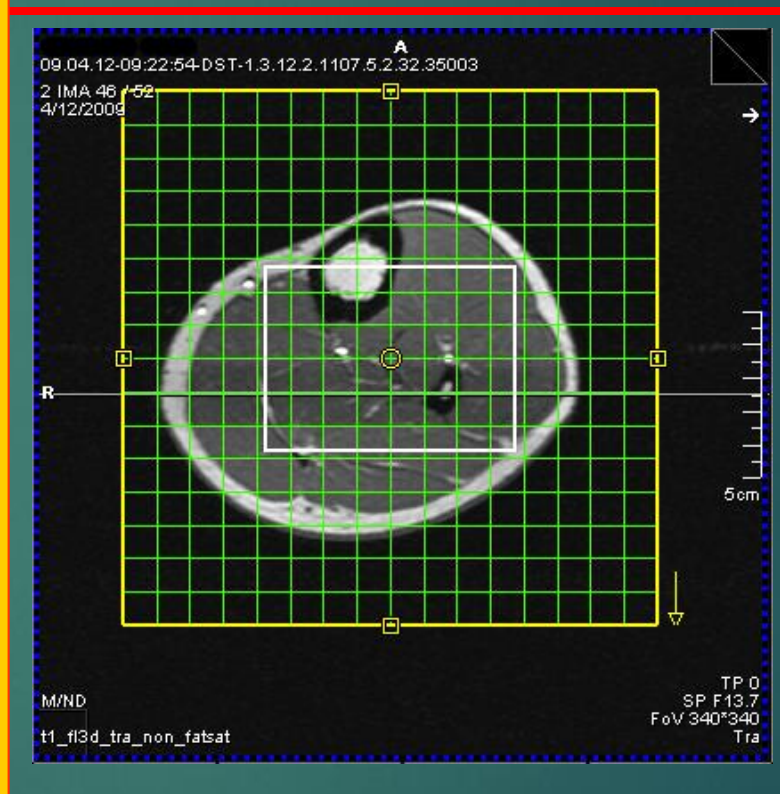
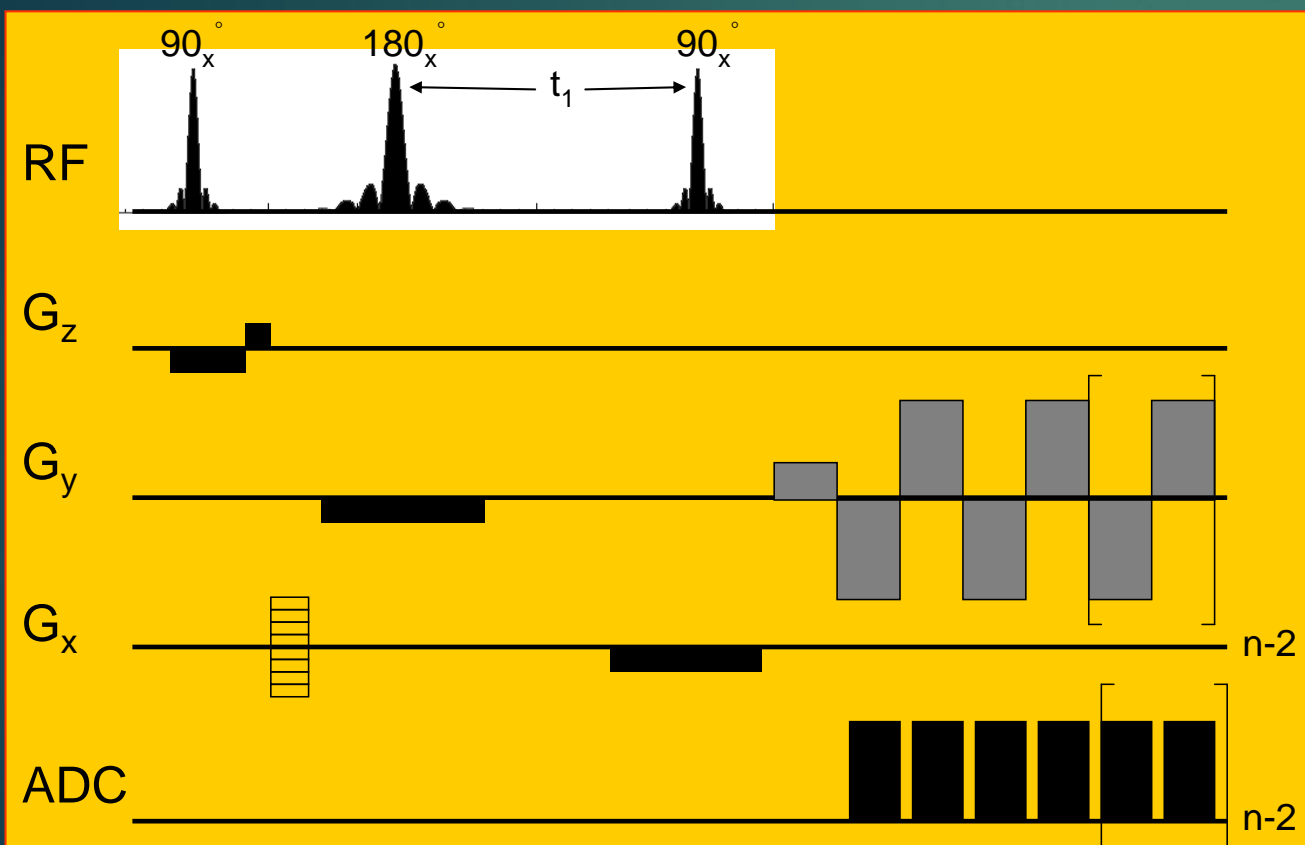

$$\text{Scan time} = N_{(\text{X-Phase Encodings})} * N_{(t_1 \text{ Encodings})} * \text{TR}$$

$$= 2s * 128 * 1 * 16 = 68 \text{ minutes}$$

Lipnick et al, MRM 2010

# EP-COSY of Human Calf *in vivo*

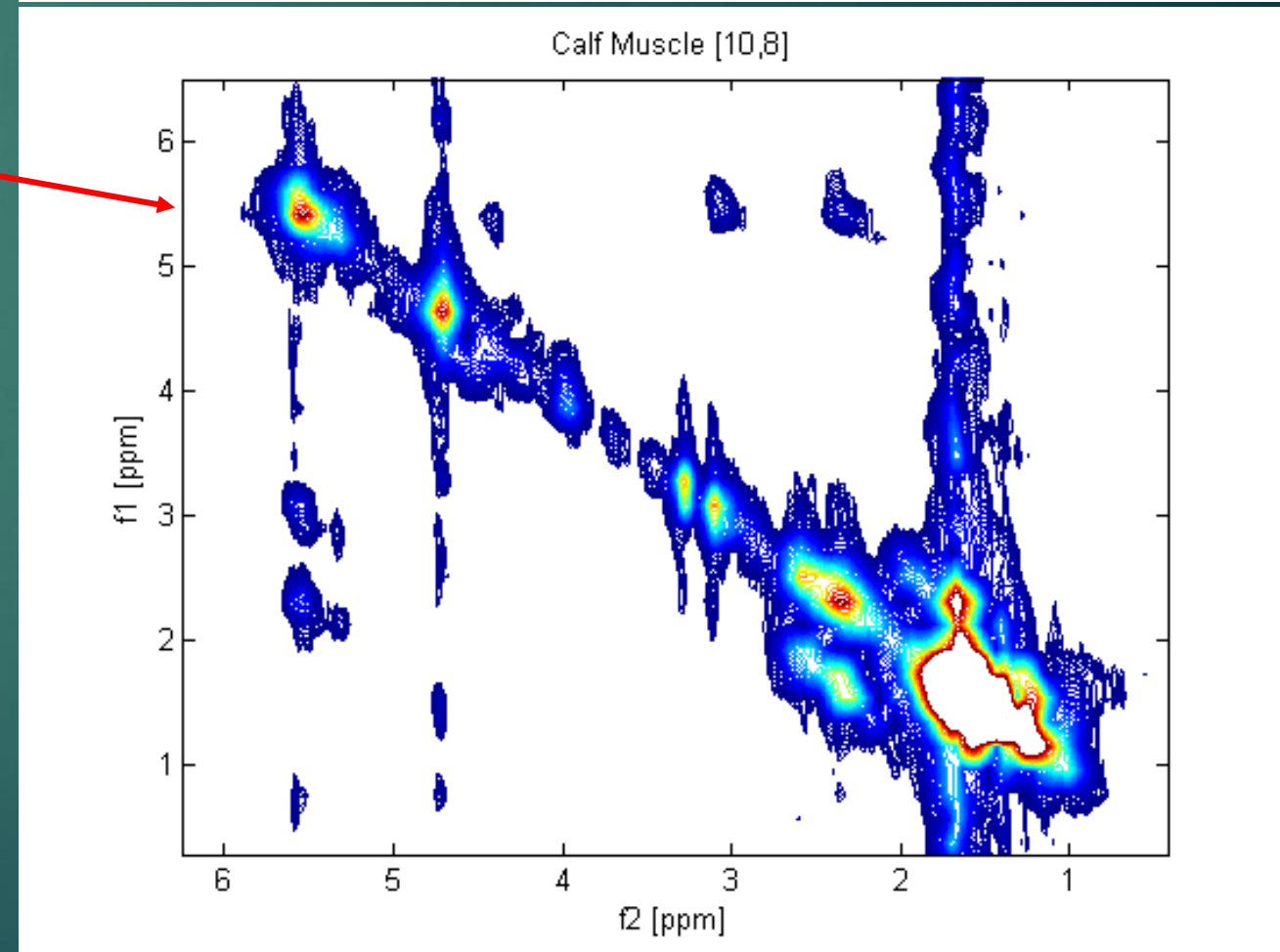
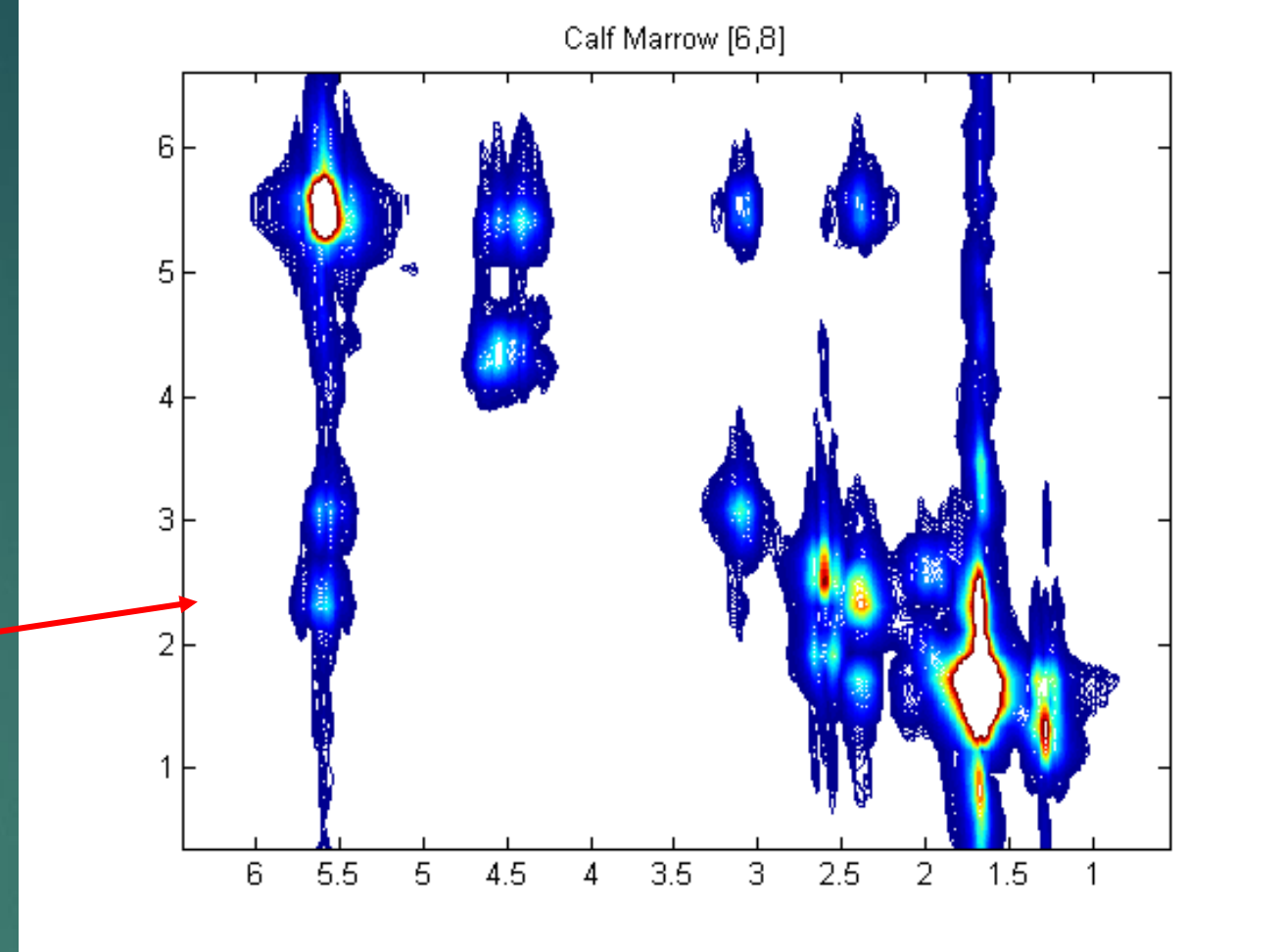
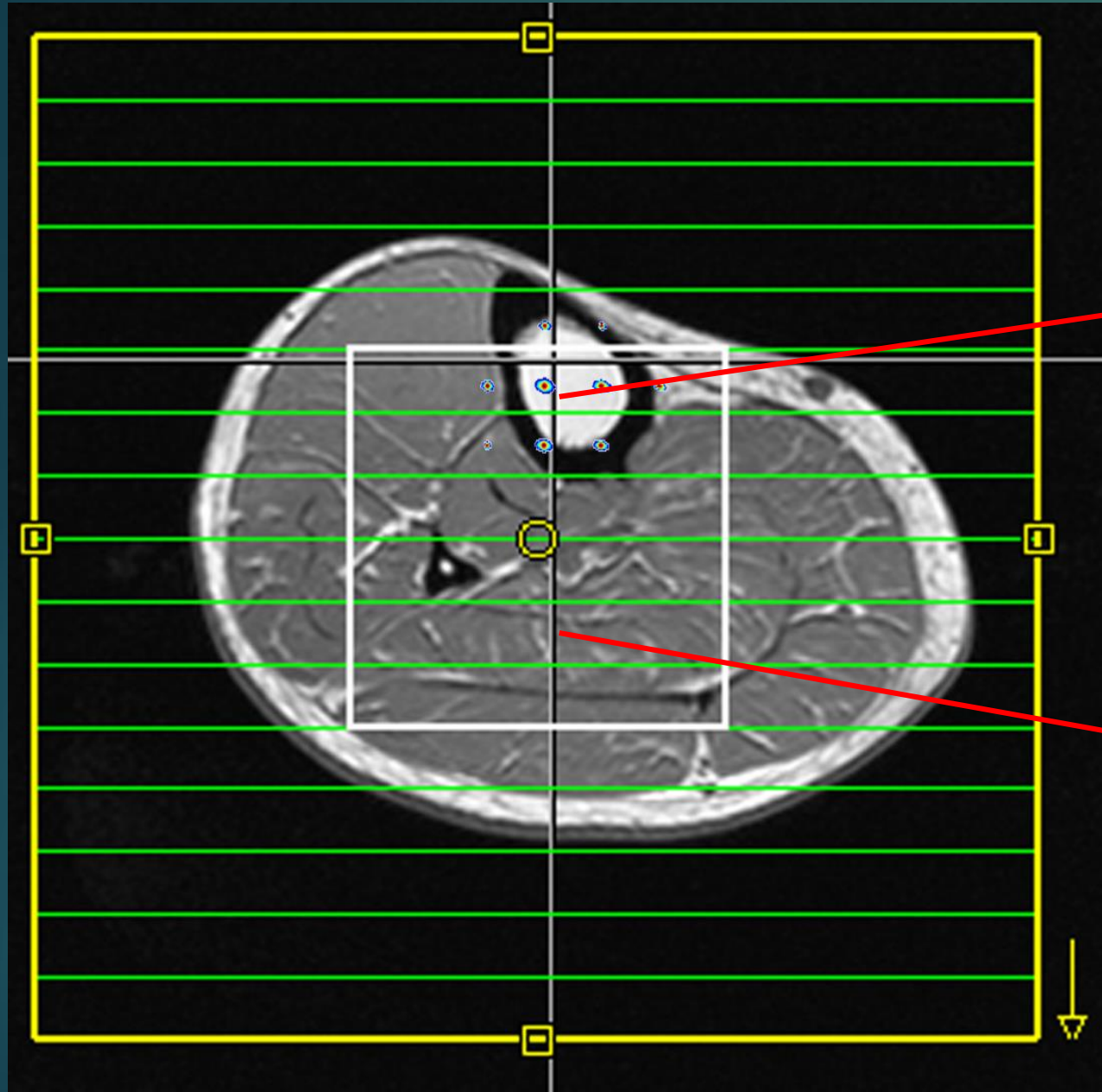

3T MRI, TR/TE=1.5s/30ms,  
CP-Ext (T/R), 16x16 (x,y), FOV 16cm,  
Extracted VOI of 1x1x2cm<sup>3</sup> and  
Total Duration of 20 minutes



# 5. 2D spectral+ 3D Spatial Encoding



# 5D Echo-Planar J-resolved Spectroscopic Imaging with NUS

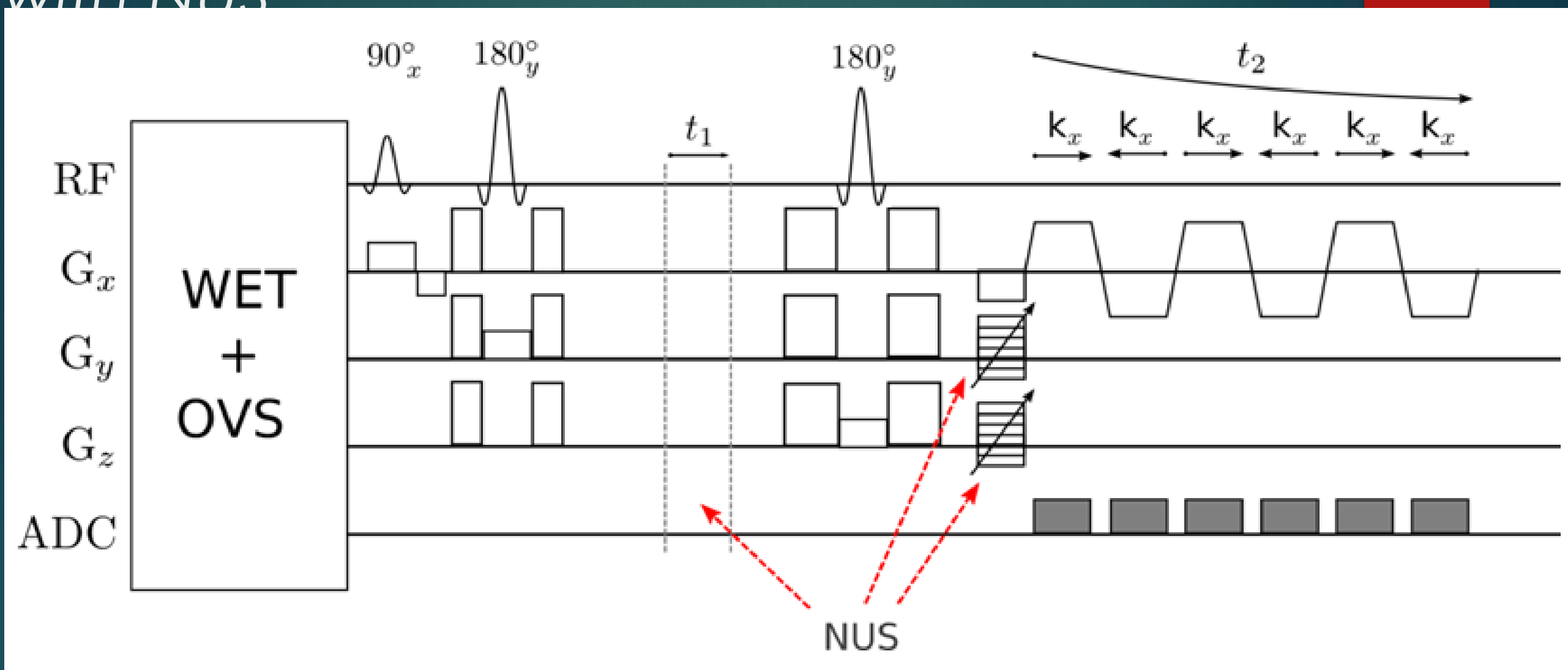

- 3D CSI/MRSI (32x32x16) -410 minutes
  - 3D EPSI (32x16) – 12.8 minutes
- 3D EPSI+2DJRES (32x16x64)- 819 minutes
- 5D EPJRESI (16x8x64) 8X NUS- 21 minutes

NAA Glx Cr tCho mI

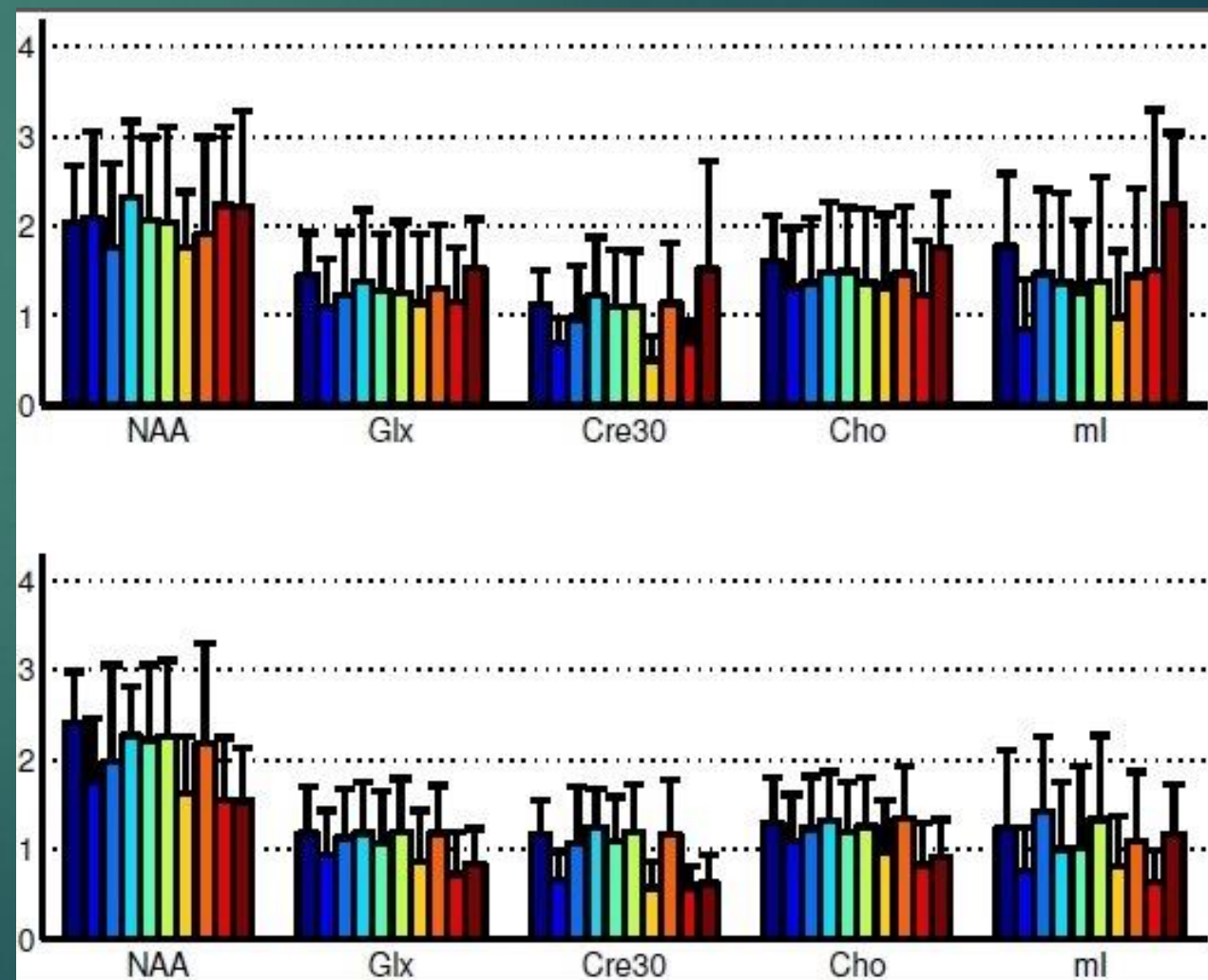
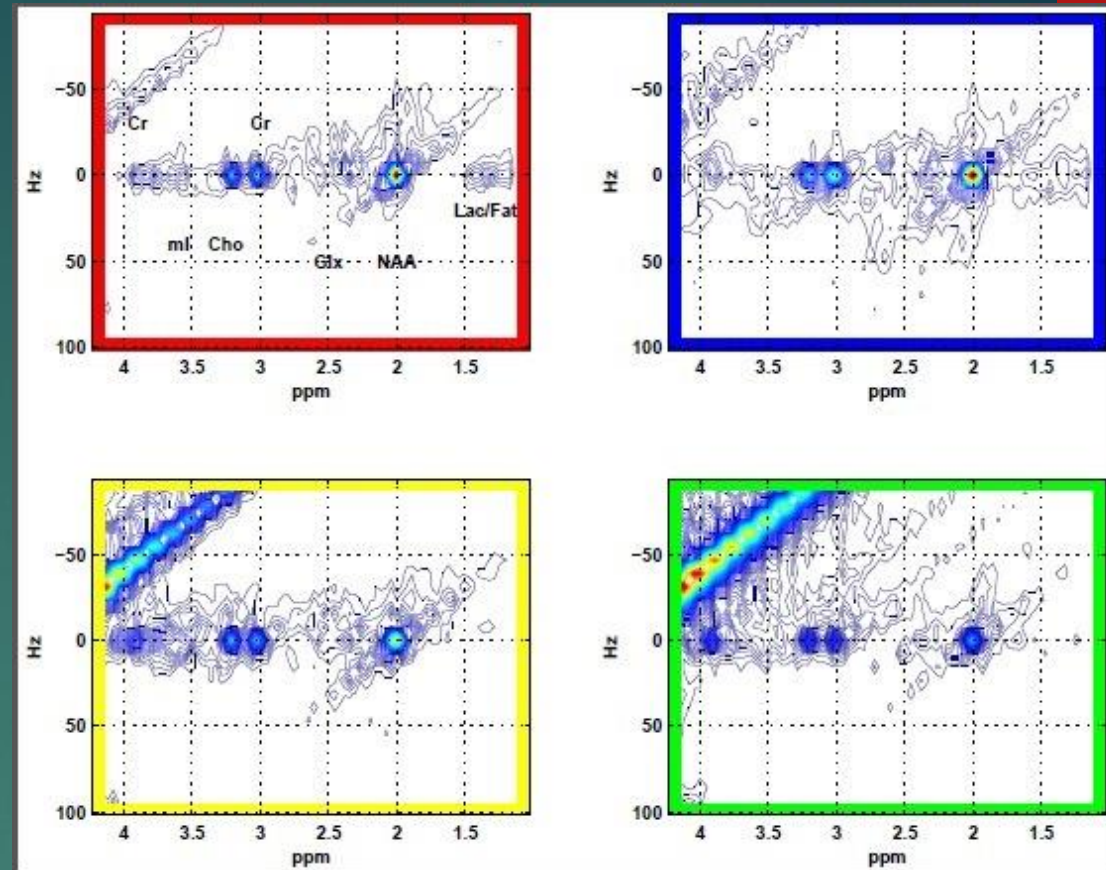
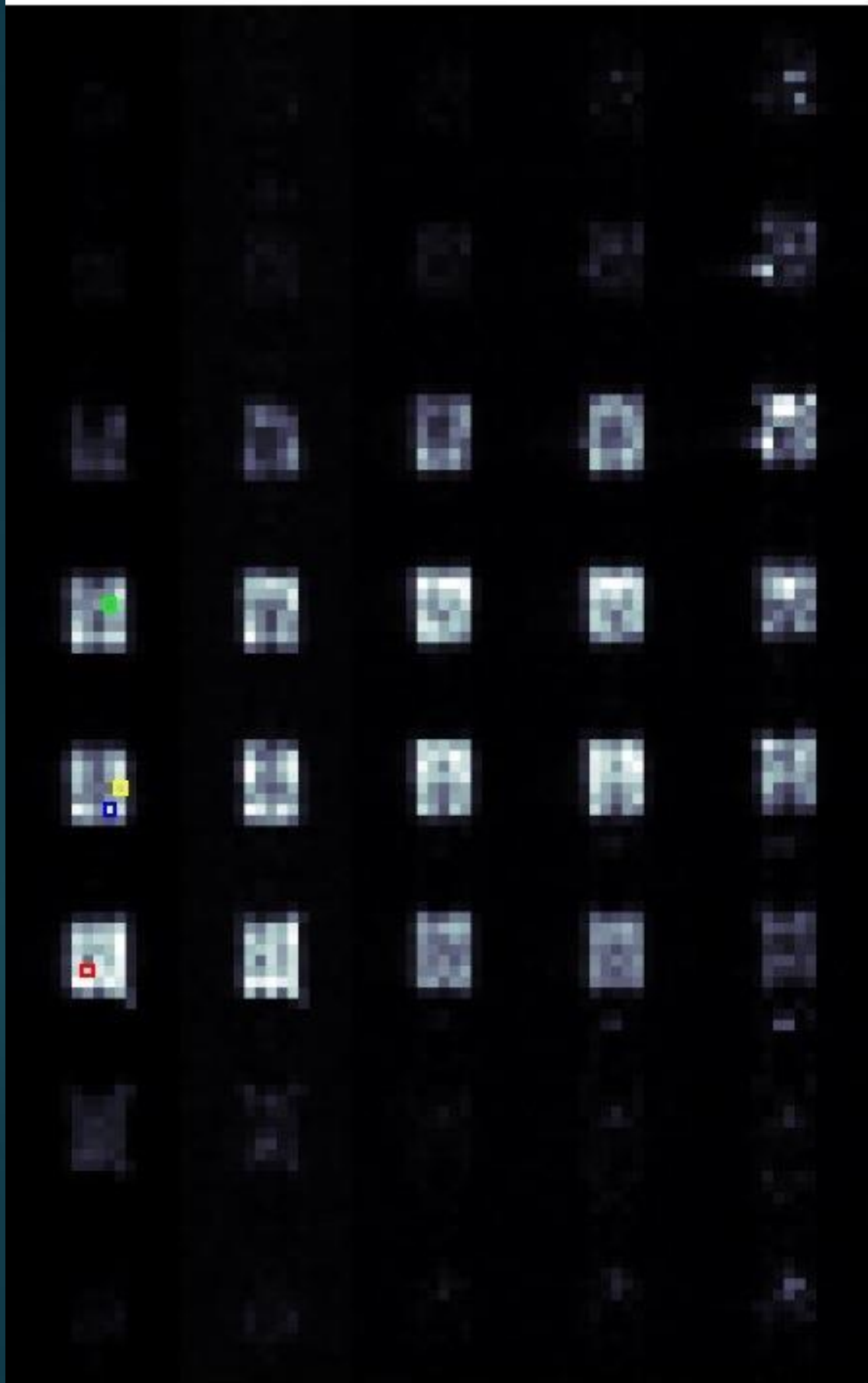

5D EP-JRESI 8X NUS-21 min

Wilson et al, MRM 2016

# 5D EP-JRESI 8X- OSA

Metabolites →	NAA	Ch	ml	Glx
<b>Healthy Controls</b>				
Occipital White	16.94	8.52	14.33	6.08
Occipetal Gray	1.62	1.56	2.79	10.82
Left Insular Cortex	7.30	6.53	5.19	2.90
Left Parietal Insular Cortex	1.17	8.82	10.31	6.58
<b>OSA patients post CPAP</b>				
Occipital White	9.20	4.92	8.70	14.50
Occipetal Gray	6.03	3.20	4.00	10.00
Left Insular Cortex	2.70	1.22	18.69	1.40
Left Parietal Insular Cortex	2.70	1.97	14.81	9.56

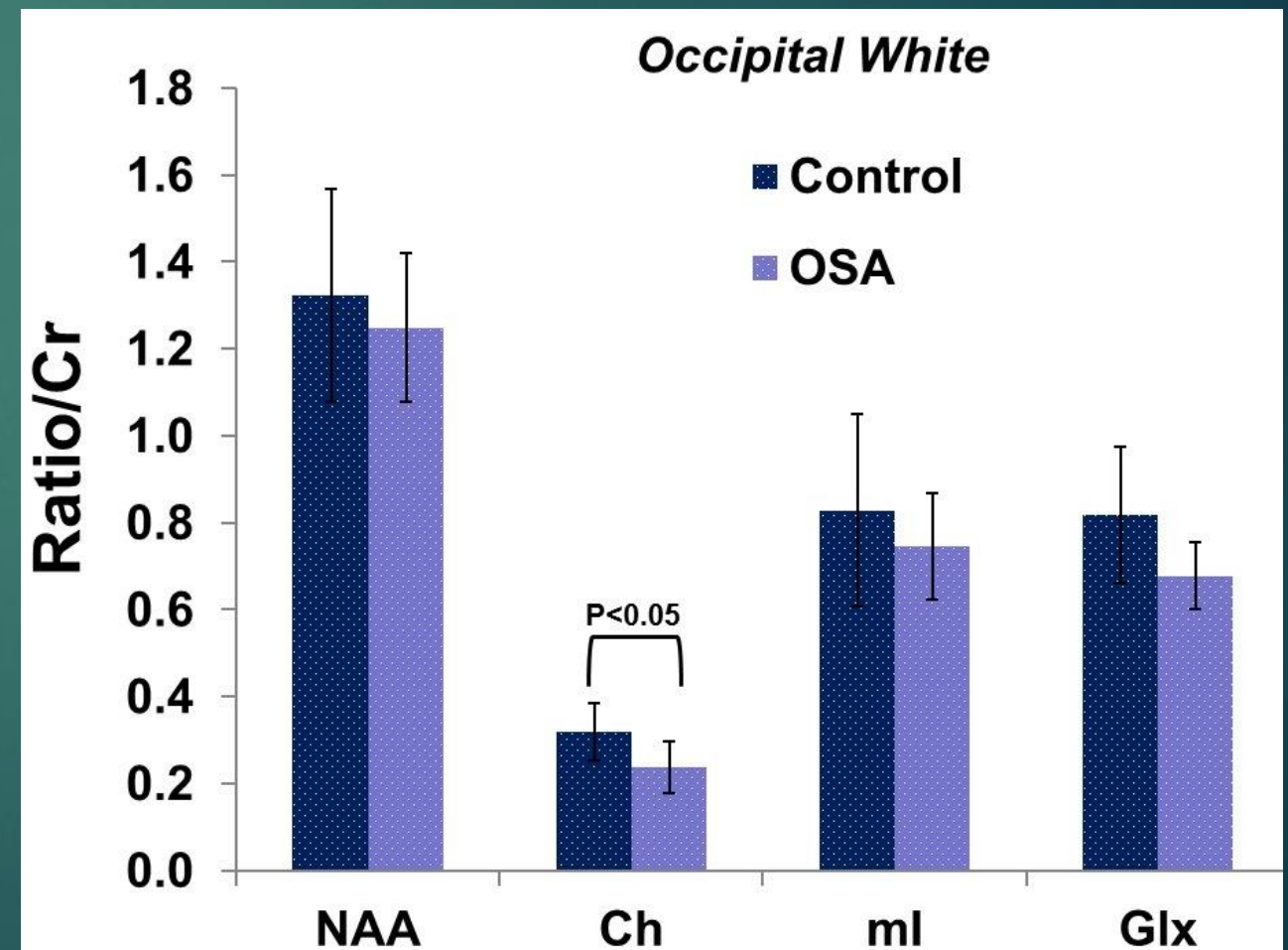
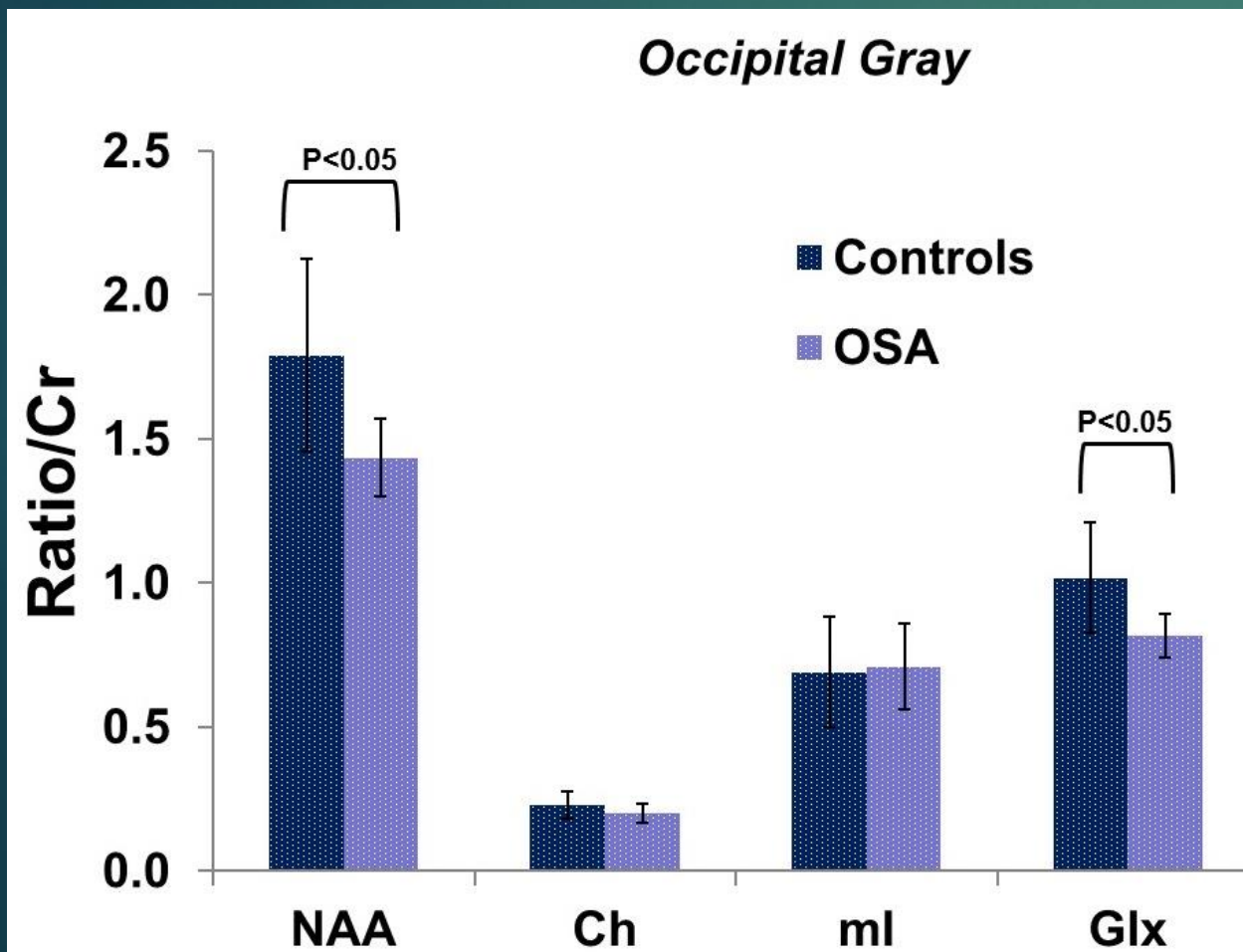



# Overview of an MRI scanner

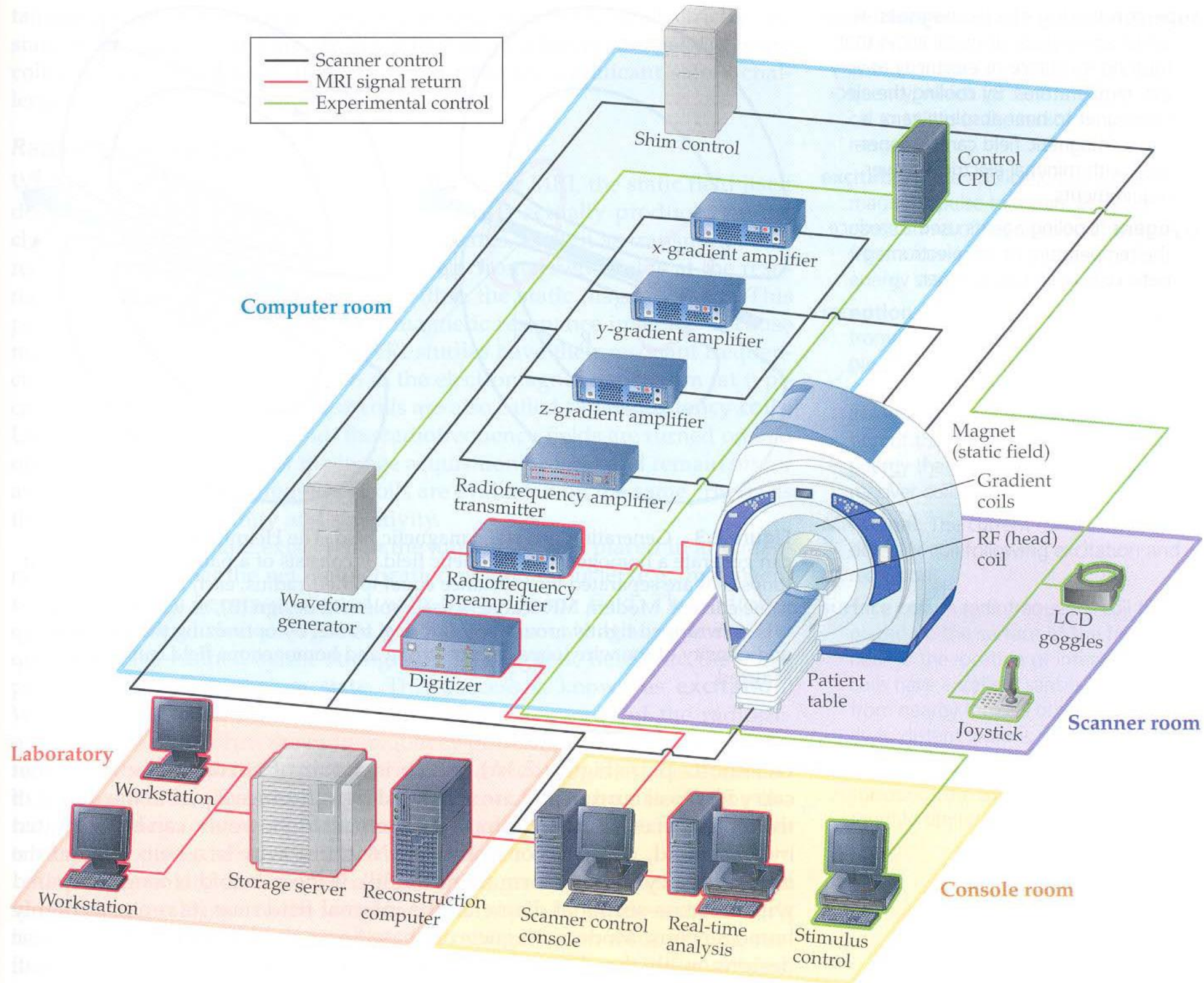



# Conclusions

- MRI has become a revolution in Medicine during our time, thanks to NMR!
  - MRI sequences can be easily translated into MR Spectroscopic Imaging
- EPSI, Spiral, SI-CONCEPT and Radial EPSI have been implemented on MRI scanners on 3T, 7T and 9.4T MRI scanners
- Accelerated Polar and Radial MRSI data need gridding to Cartesian; acquisition less than 5 minutes may facilitate functional MRSI
- 3spatial+2 spectral accelerated acquisition & the MRSI data can be post-processed using linear and non-linear reconstruction (Compressed Sensing)
  - 6D MRSI (3spatial+3 spectral) and more.....





**THANK YOU**