RF Pulse Design: Multi-Dimensional Excitation

M229 Advanced Topics in MRI

Holden H. Wu, Ph.D.

2023.04.20

UCLA

*Department of Radiological Sciences
David Geffen School of Medicine at UCLA*

Class Business

- Office hours
 - Holden: Fri 10-11 am
 - Shu-Fu (TA for HW1): Mon 2-4 pm
 - Timo (TA for HW2): Wed 1-3 pm
- Homework 1 is due on 4/28 (Friday)
- Homework 2 is due on 5/5 (Friday)

Outline

- Review of adiabatic pulses
- Small tip approximation
- Excitation k-space interpretation
- 2D EPI pulse design
- MATLAB demo
- Homework 2

Review of Adiabatic Pulses

Adiabatic Pulses

- Flip Angle $\neq \int_0^T B_1(t)dt$
- Amplitude and frequency modulation
- Long duration (8-12 ms)
- High B1 amplitude ($>12 \mu\text{T}$)
- Generally NOT multi-purpose (inversion pulses cannot be used for refocusing, etc.)

Non-adiabatic Pulses

- Flip Angle $= \int_0^T B_1(t)dt$
- Amplitude modulation with constant carrier frequency
- Short duration (0.3-1 ms)
- Low B1 amplitude
- Generally multi-purpose (inversion pulses can be used for refocusing, etc.)

Bloch Equation

$$\frac{d\vec{M}}{dt} = \vec{M} \times \gamma \vec{B}_{eff}$$

Non-selective vs. Selective Excitation

$$\vec{B}_{eff} = \begin{pmatrix} B_1(t) \\ 0 \\ B_0 - \frac{\omega}{\gamma} \end{pmatrix} \quad \vec{B}_{eff} = \begin{pmatrix} B_1(t) \\ 0 \\ B_0 - \frac{\omega}{\gamma} + G_z z \end{pmatrix}$$

Adiabatic Pulses

$$\vec{B}_{eff} = \begin{pmatrix} A(t) \\ 0 \\ B_0 - \frac{\omega}{\gamma} + \frac{\omega_1(t)}{\gamma} \end{pmatrix}$$

Adiabatic Inversion

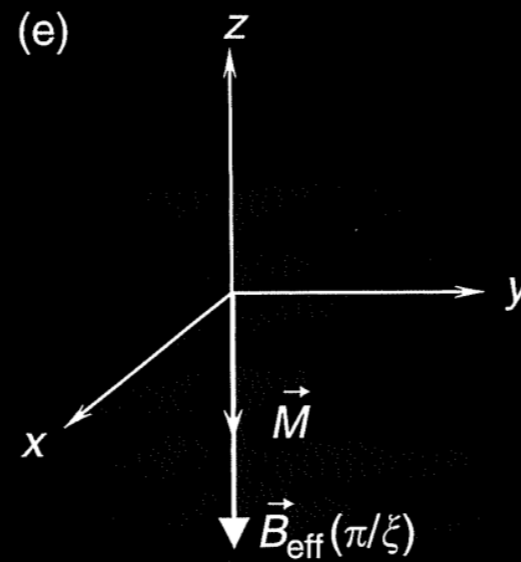
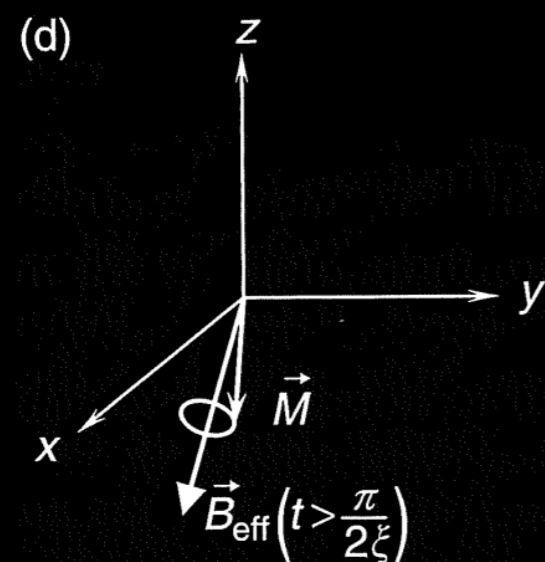
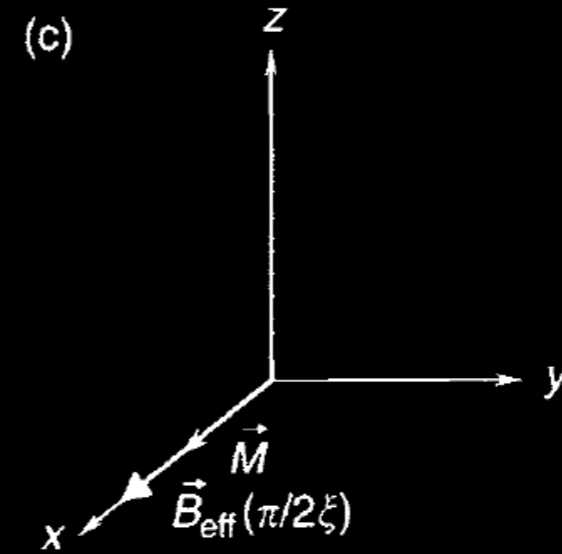
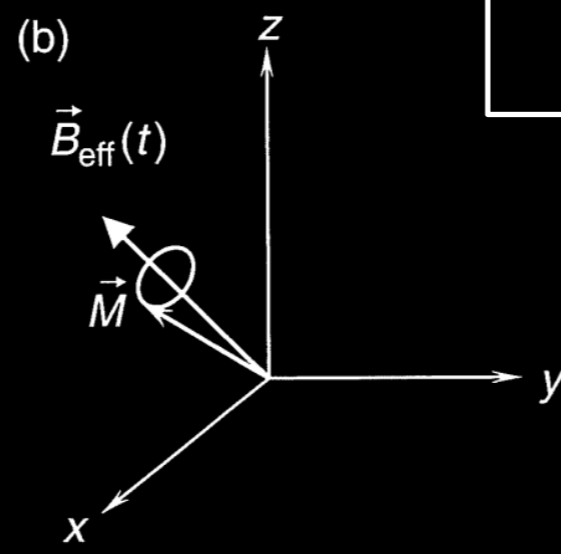
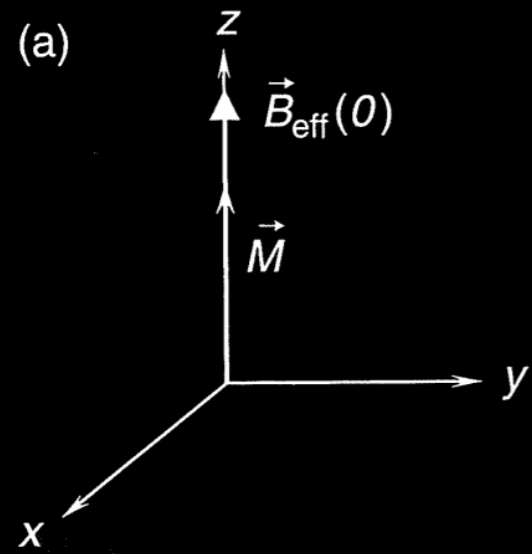
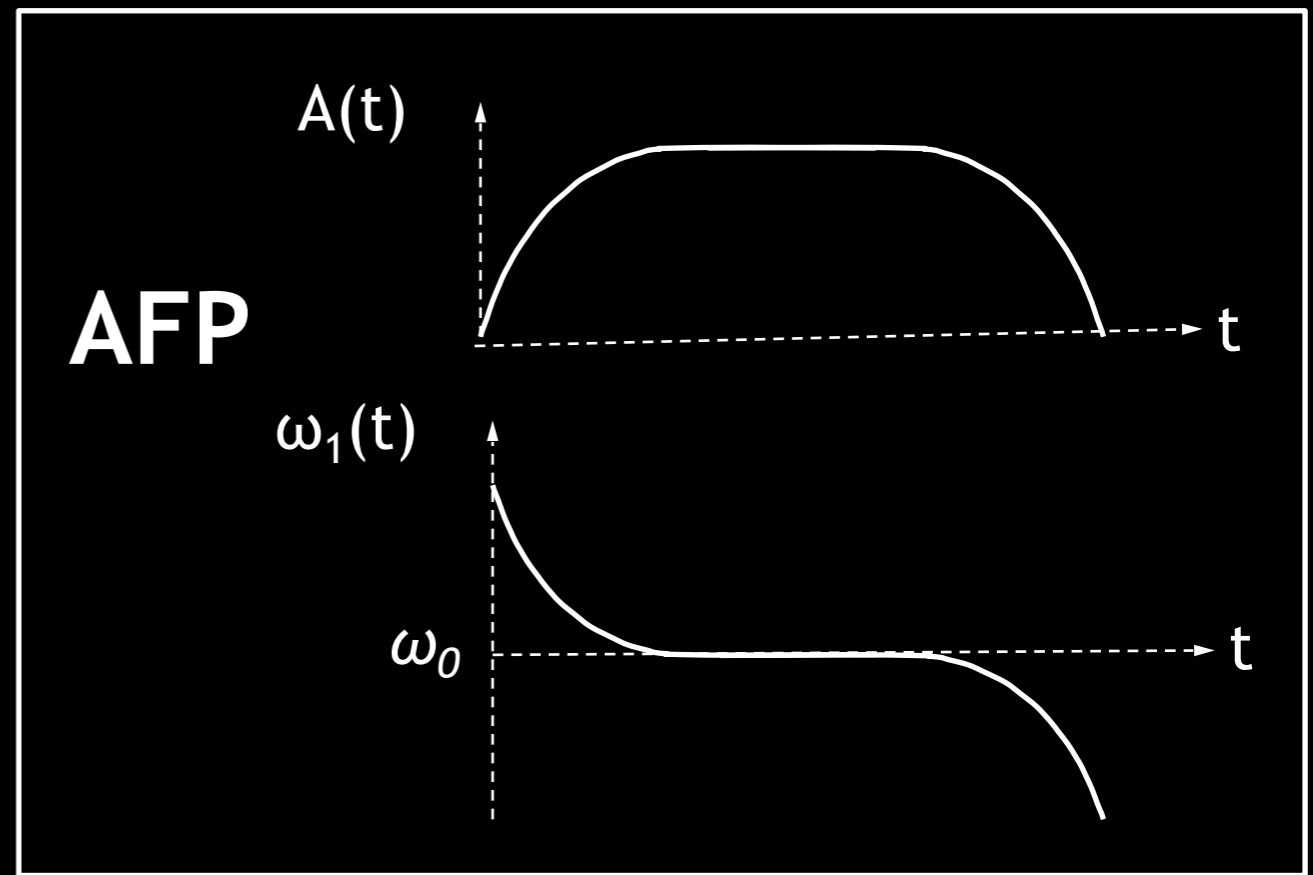

Hyperbolic Secant Pulse Example

Amplitude Modulation, $A(t)$

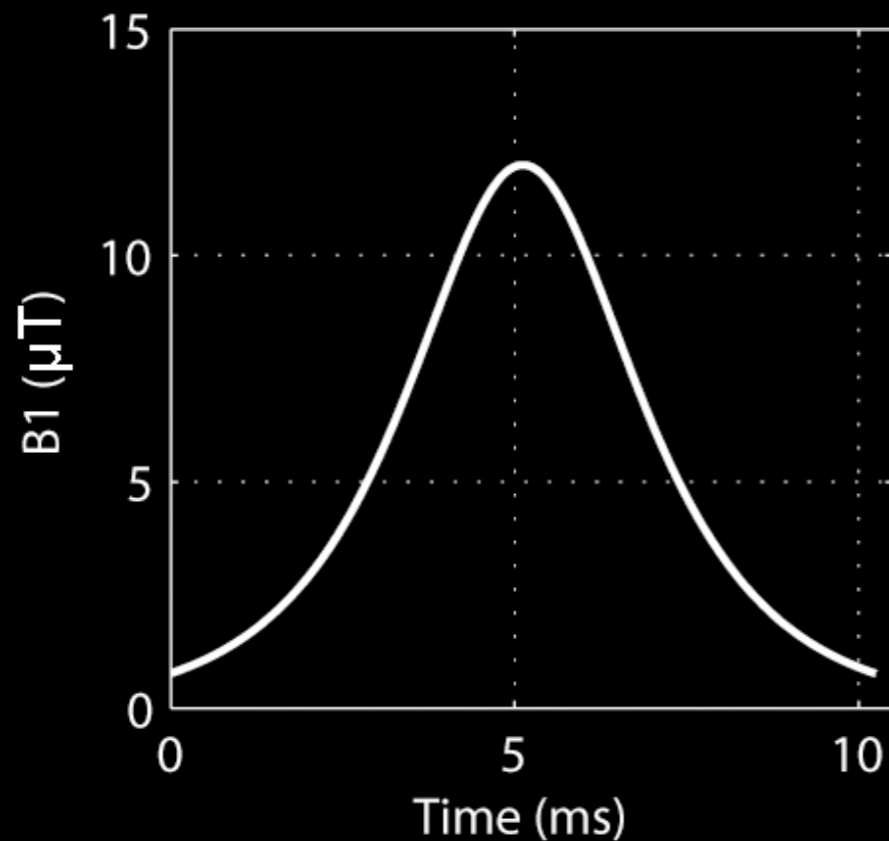

Frequency Modulation, $\omega_1(t)$

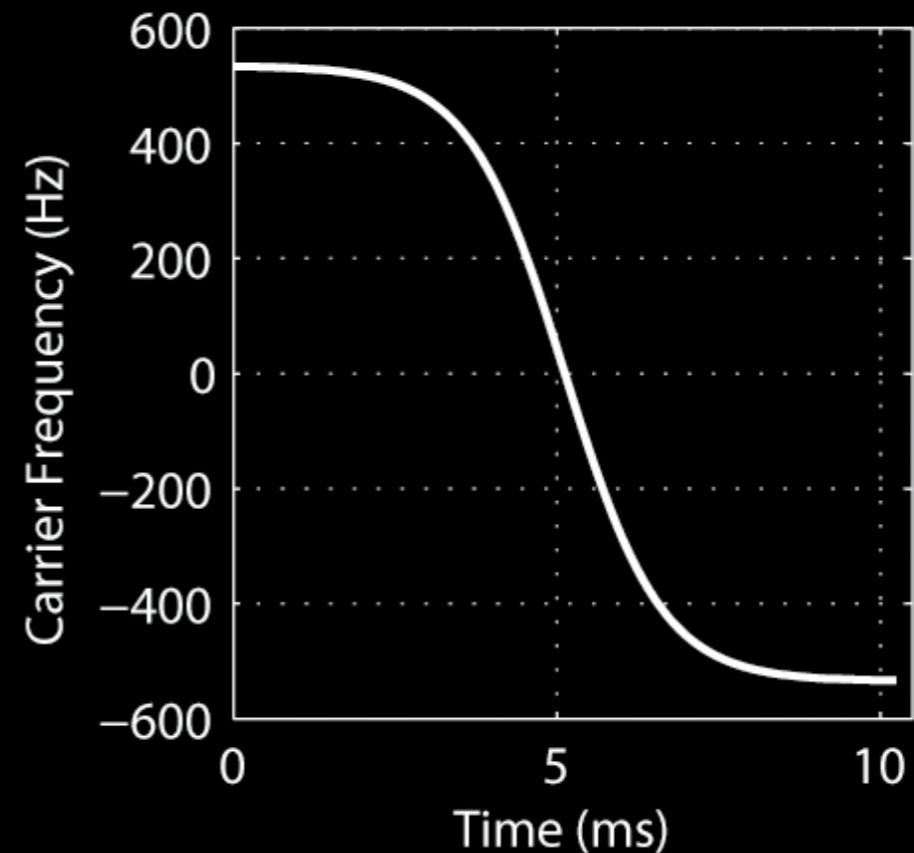

Pulse Parameters:

$$A_0 = 12 \mu T$$

$$\mu = 5$$

$$\beta = 672 \text{ rad/s}$$

$$\text{Duration} = 10.24 \text{ ms}$$

Hyperbolic Secant: Adiabatic Property

Original Pulse (100%)

$$B_{1\text{max}} = 12 \mu\text{T}$$

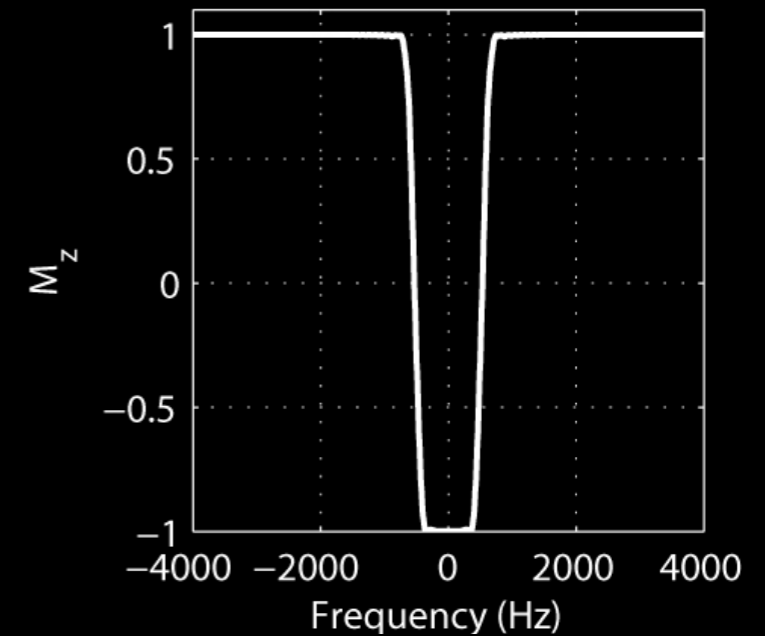
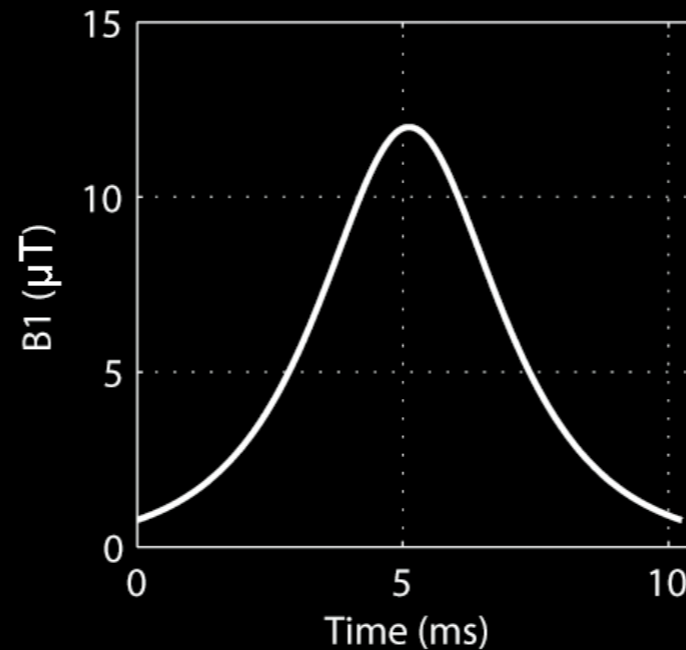

60% Attenuated Pulse

$$B_{1\text{max}} = 7.2 \mu\text{T}$$

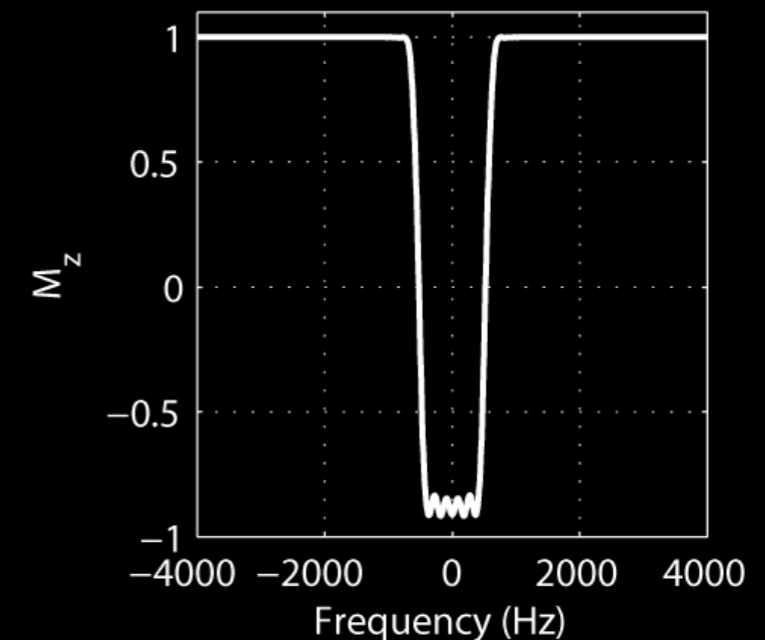
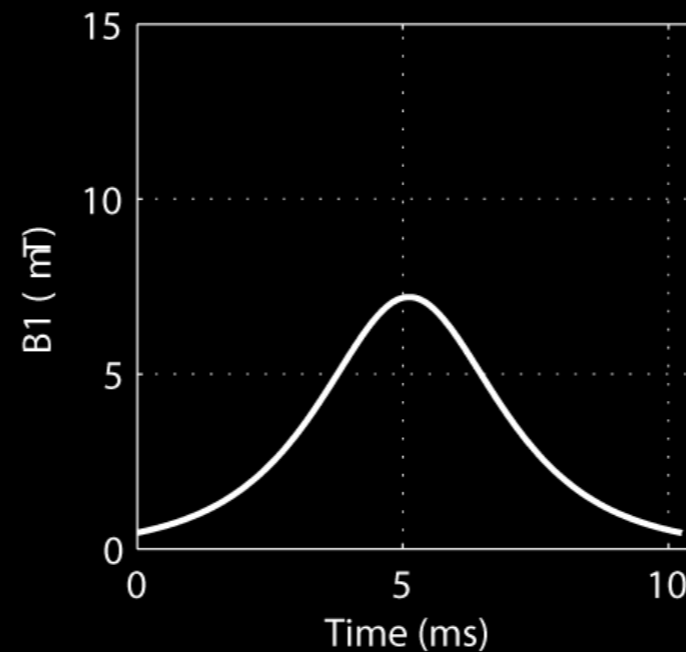

B_1 Threshold $\approx 6 \mu\text{T}$

Small Tip Approximation

Bloch Equation (at on-resonance)

$$\frac{d\vec{M}_{rot}}{dt} = \vec{M}_{rot} \times \gamma \vec{B}_{eff}$$

where $\vec{B}_{eff} = \begin{pmatrix} B_1(t) \\ 0 \\ \cancel{B_0} + \frac{\omega}{\gamma} + G_z z \end{pmatrix}$

When we simplify the cross product,

$$\frac{d\vec{M}}{dt} = \begin{pmatrix} 0 & \omega(z) & 0 \\ -\omega(z) & 0 & \omega_1(t) \\ 0 & -\omega_1(t) & 0 \end{pmatrix} \vec{M}$$

$$\omega(z) = \gamma G_z z \quad \omega_1(t) = \gamma B_1(t)$$

Small Tip Approximation

$$\frac{d\vec{M}}{dt} = \begin{pmatrix} 0 & \omega(z) & 0 \\ -\omega(z) & 0 & \omega_1(t) \\ 0 & -\omega_1(t) & 0 \end{pmatrix} \vec{M}$$

$M_z \approx M_0$ small tip-angle approximation

$$\sin \theta \approx \theta$$

$$\cos \theta \approx 1$$

$$M_z \approx M_0 \rightarrow \text{constant}$$

$$\left. \begin{array}{l} \sin \theta \approx \theta \\ \cos \theta \approx 1 \\ M_z \approx M_0 \rightarrow \text{constant} \end{array} \right\} \frac{dM_z}{dt} = 0$$

$$\frac{dM_{xy}}{dt} = -i\gamma G_z z M_{xy} + i\gamma B_1(t) M_0$$

$$M_{xy} = M_x + iM_y$$

First order linear differential equation. Easily solved.

$$\frac{dM_{xy}}{dt} = -i\gamma G_z z M_{xy} + i\gamma B_1(t) M_0$$

Solving a first order linear differential equation:

$$M_{xy}(t, z) = i\gamma M_0 \int_0^t B_1(s) e^{-i\gamma G_z z \cdot (t-s)} ds$$



$$M_r(\tau, z) = iM_0 e^{-i\omega(z)\tau/2} \cdot \mathcal{FT}_{1D}\left\{\omega_1\left(t + \frac{\tau}{2}\right)\right\} \Big|_{f = -(\gamma/2\pi)G_z z}$$

(See the notes for complete derivation.)

$$M_r(\tau, z) = iM_0 e^{-i\omega(z)\tau/2} \cdot \mathcal{FT}_{1D}\left\{\omega_1\left(t + \frac{\tau}{2}\right)\right\} \Big|_{f = -(\gamma/2\pi)G_z z}$$

To the board ...

Small Tip Approximation

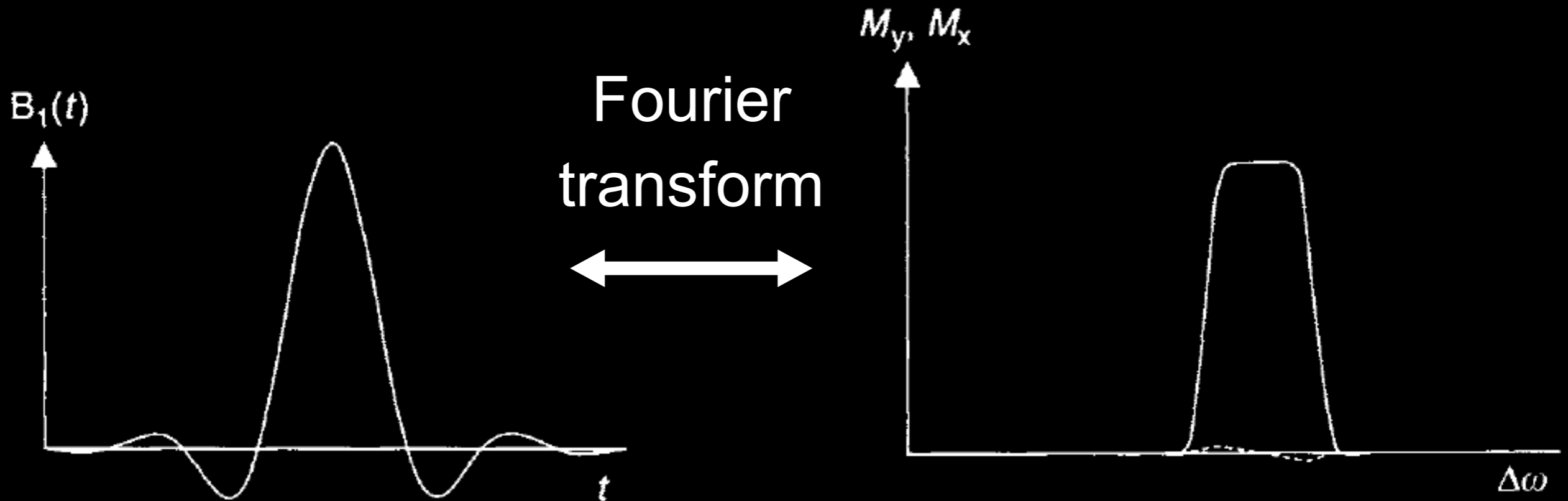

- For small tip angles, “the slice or frequency profile is well approximated by the Fourier transform of $B_1(t)$ ”
- The approximation works surprisingly well even for flip angles up to 90°

Excitation k-space Interpretation

Small Tip Approximation

$$M_{xy}(t, z) = i\gamma M_0 \int_0^t B_1(s) e^{-i\omega(z)(t-s)} ds$$

$$\omega(z) = \gamma G_z z \quad \longrightarrow \quad \omega(\vec{r}, t) = \gamma \vec{G}(t) \vec{r}$$

$$M_{xy}(t, \vec{r}) = i\gamma M_0 \int_0^t B_1(s) e^{-i\gamma \int_s^t \vec{G}(\tau) d\tau \cdot \vec{r}} ds$$

Small Tip Approximation

$$M_{xy}(t, \vec{r}) = i\gamma M_0 \int_0^t B_1(s) e^{-i\gamma \int_s^t \vec{G}(\tau) d\tau \cdot \vec{r}} ds$$

Let us define: $\vec{k}(s, t) = -\frac{\gamma}{2\pi} \int_s^t \vec{G}(\tau) d\tau$



$$M_{xy}(t, \vec{r}) = i\gamma M_0 \int_0^t B_1(s) e^{i2\pi \vec{k}(s, t) \cdot \vec{r}} ds$$

One-Dimensional Example

$$\vec{k}(s, t) = -\frac{\gamma}{2\pi} \int_s^t \vec{G}(\tau) d\tau$$

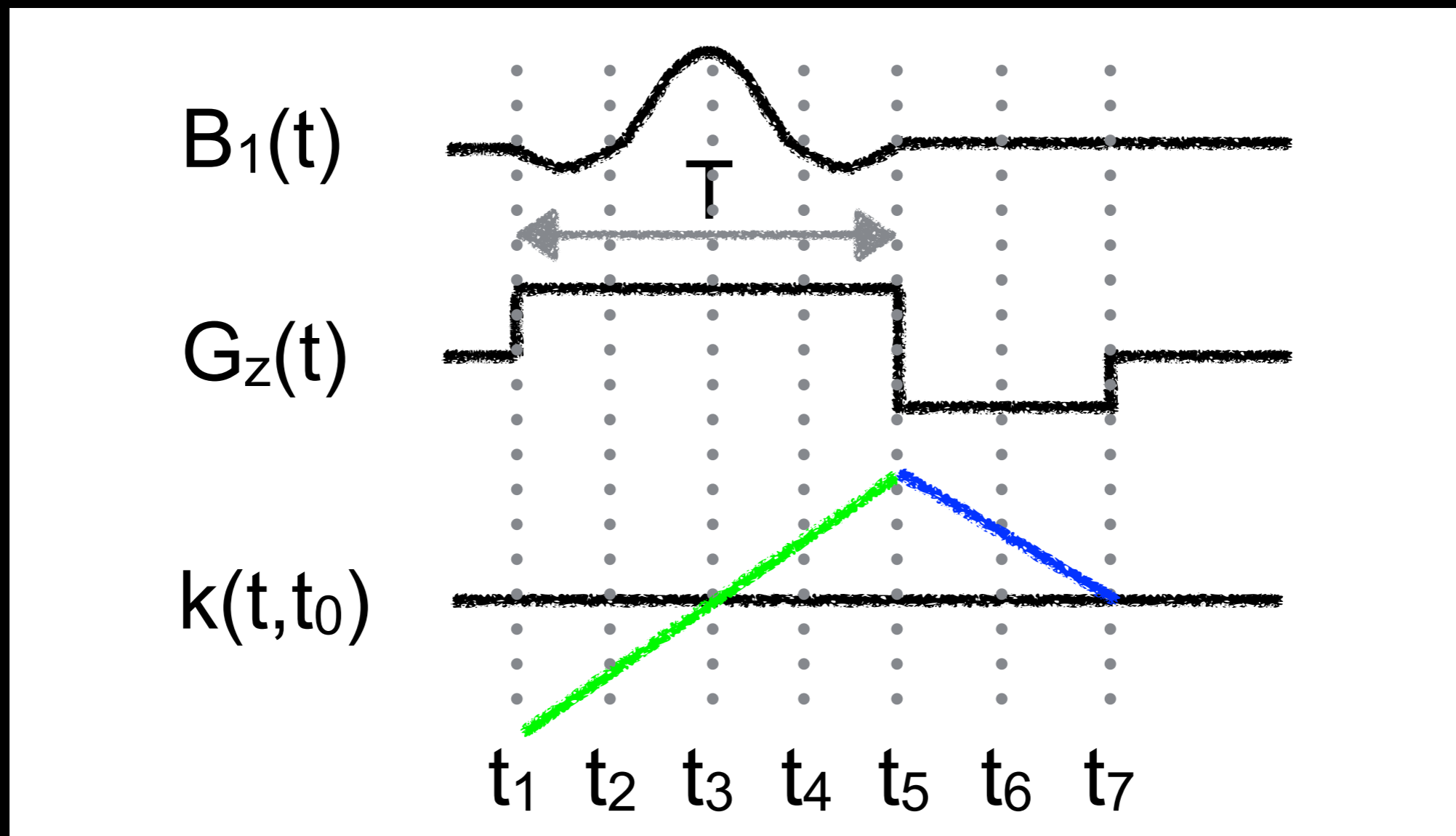

Consider the value of k at $s = t_1, t_2, \dots, t_7$

To the board ...

One-Dimensional Example

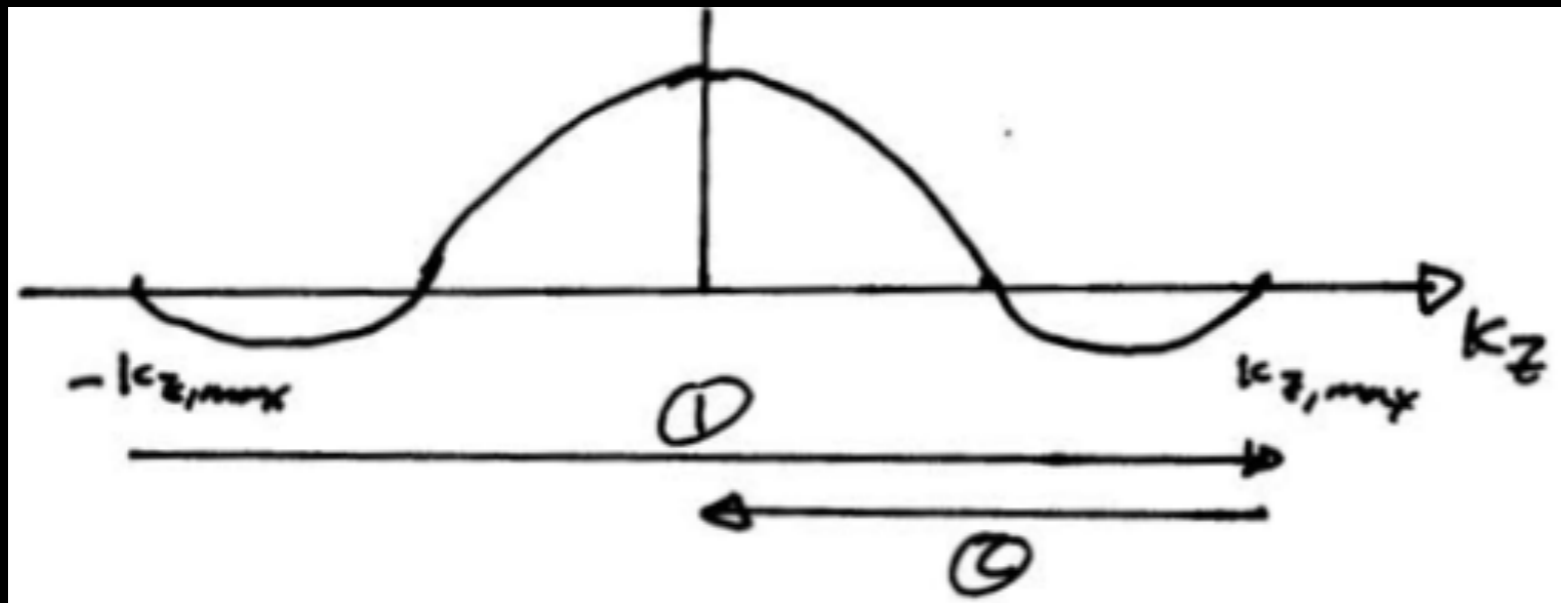

$$k_{z,max} = \frac{T}{2} \frac{\gamma}{2\pi} G_z$$

- This gives magnetization at $t = t_0$, the end of the pulse
- Looks like you scan across k-space, then return to origin

Evolution of Magnetization During Pulse

- RF pulse goes in at DC ($k_z = 0$)
- Gradients move previously applied weighting around
- Think of the RF as “writing” an analog waveform in k-space
- The effect of rephasing gradients
- Same idea applies to reception

Other 1D Examples

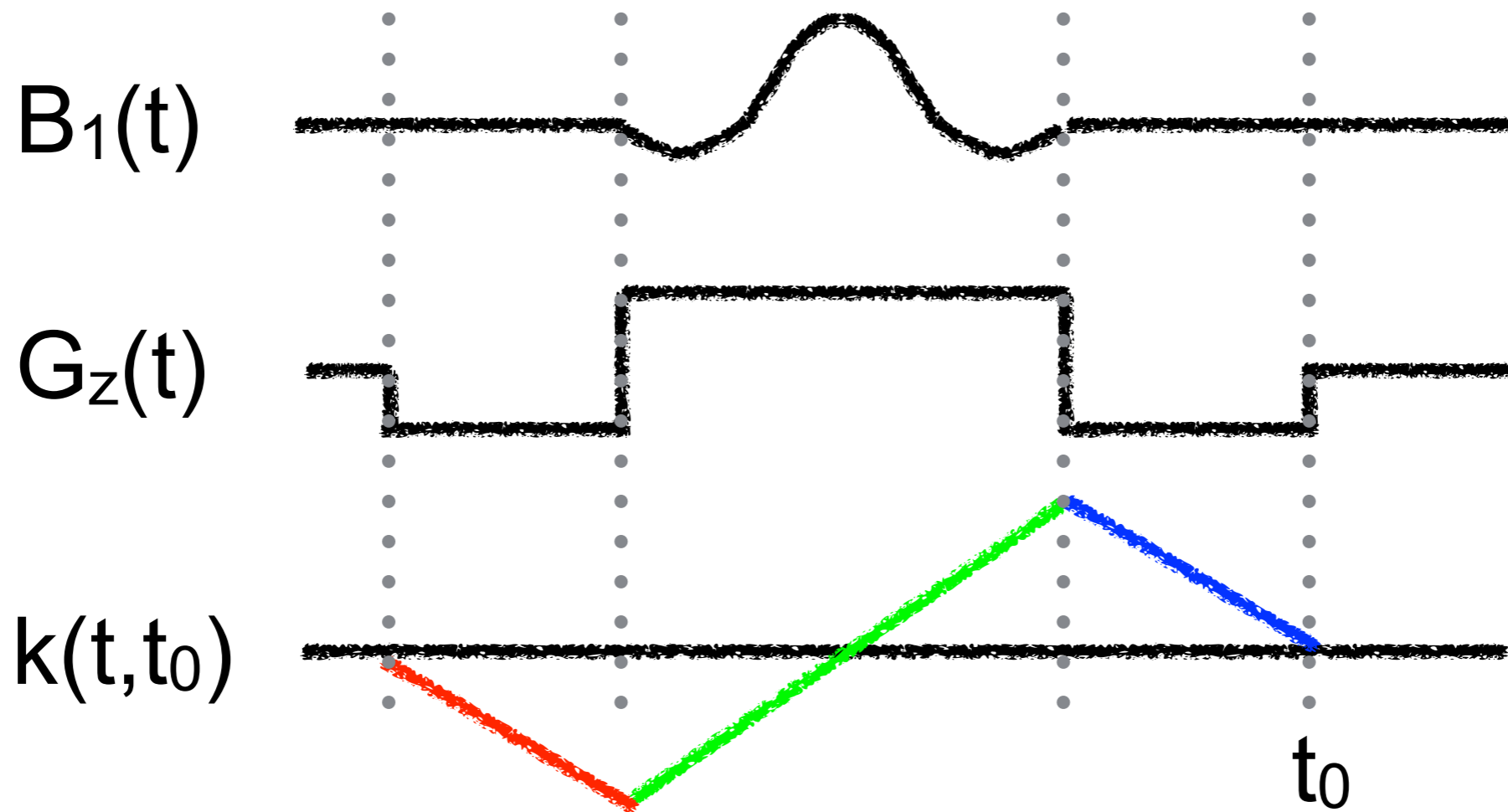

Other 1D Examples

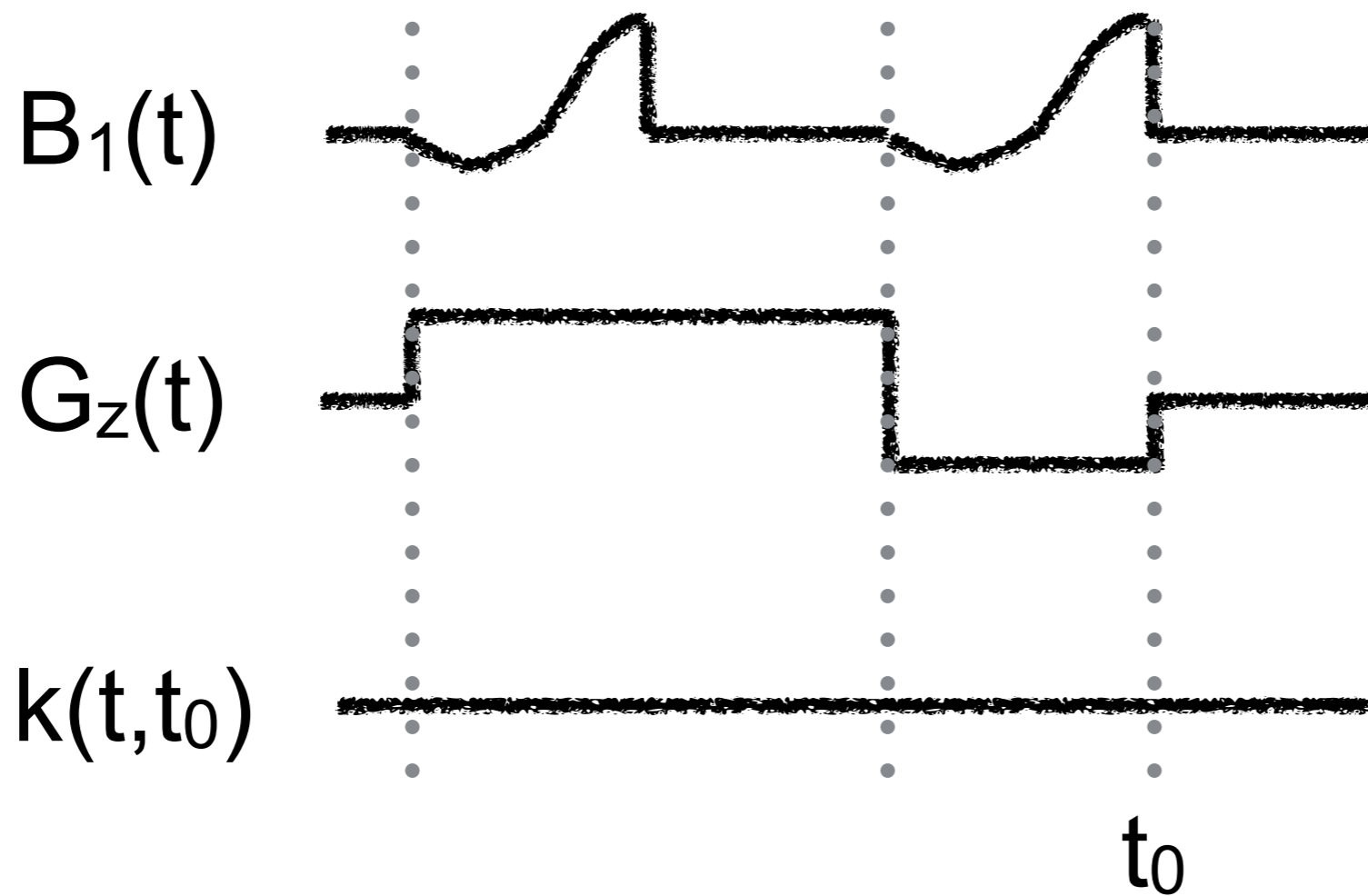

Other 1D Examples

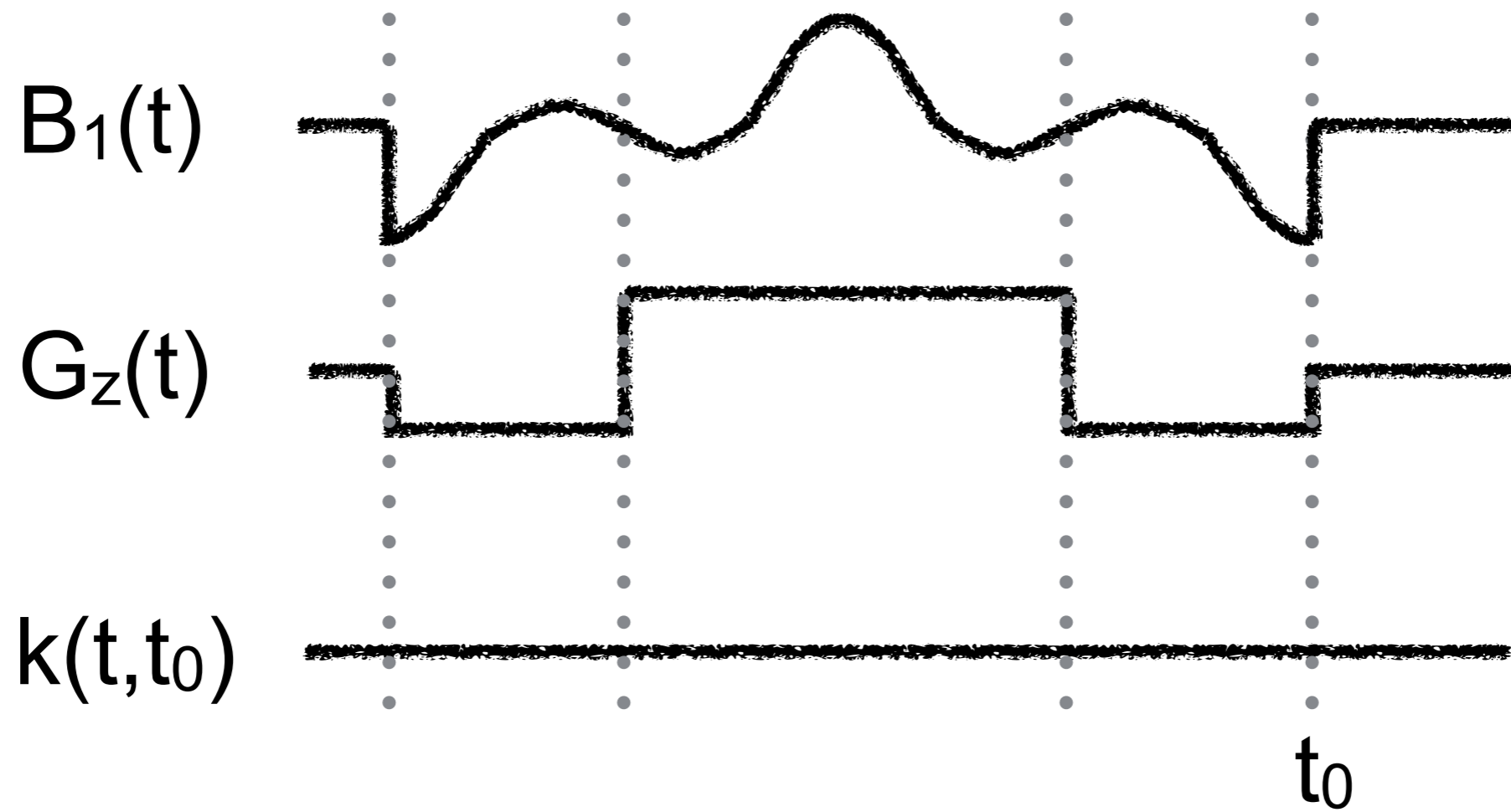

Multiple Excitations

- Most acquisition methods require several repetitions to make an image
 - e.g., 128 phase encodes
- Data is combined to reconstruct an image
- Same idea works for excitation!
 - Build up the excitation profile by traversing excitation k-space and depositing RF energy

Simple 1D Example

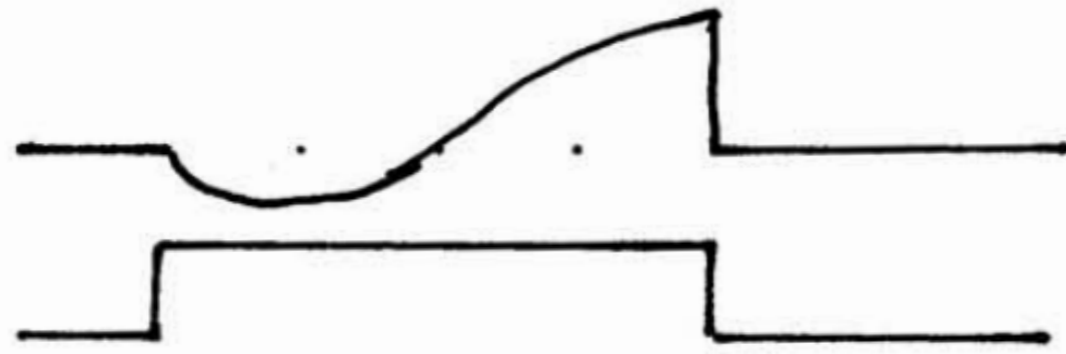

FIRST REPETITION

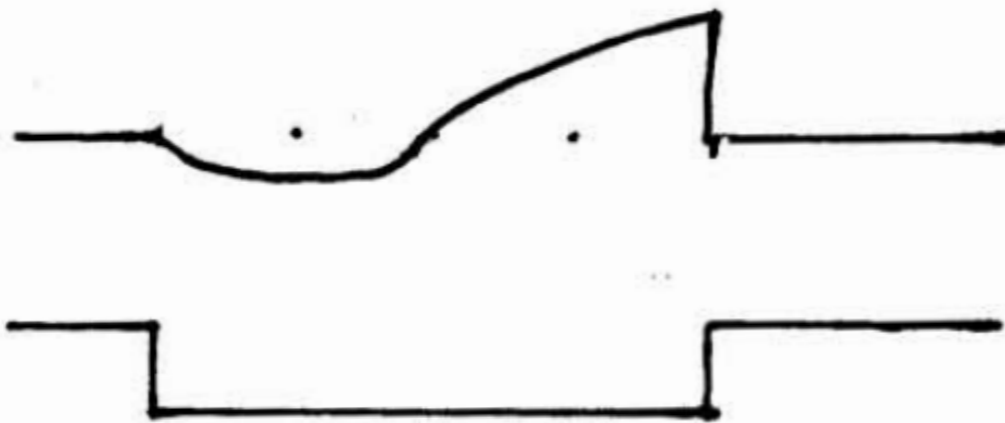

SECOND REPETITION

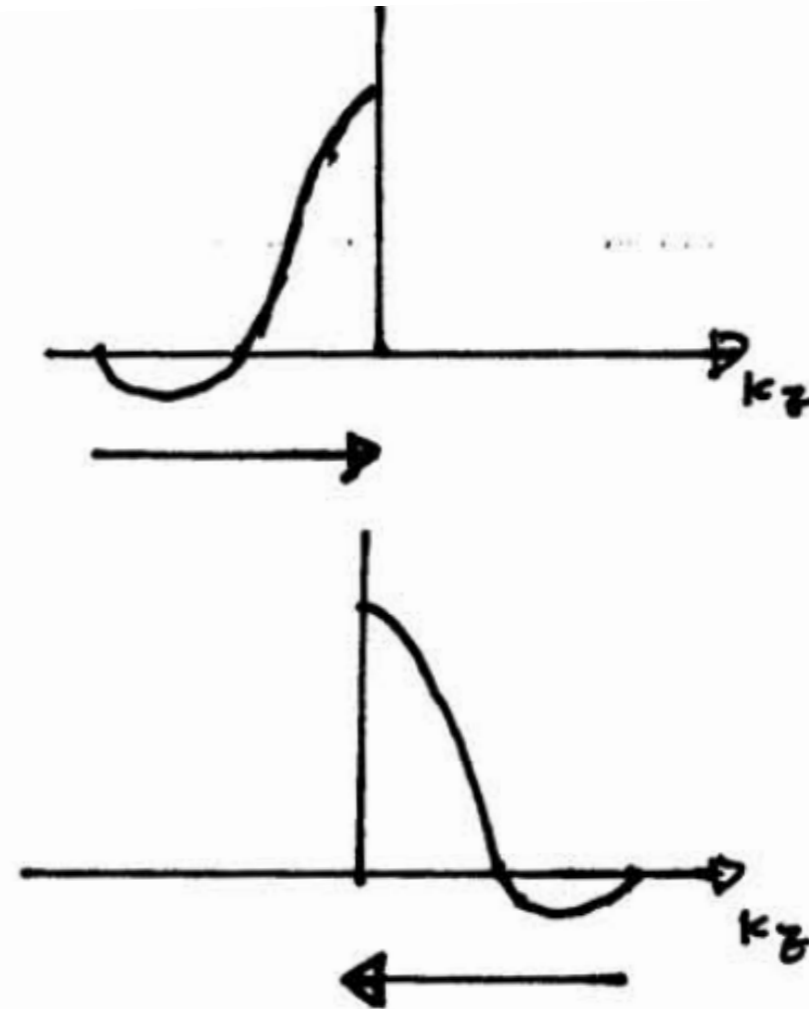

Sum the data from two acquisitions

Same profile as slice selective pulse, but zero echo time

What is Multi-Dimensional Excitation?

Multi-dimensional excitation occurs when using multi-dimensional RF pulses in MRI/NMR, i.e. 2D or 3D RF pulses

1D vs. N-D RF Pulses

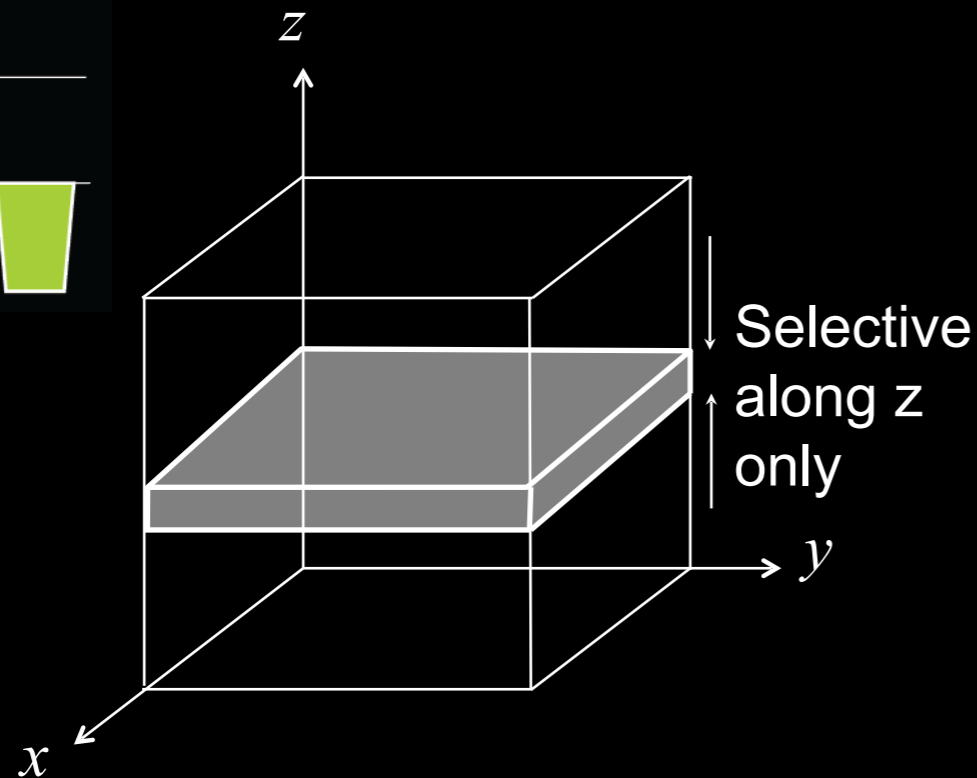

2D/N-D Pulse Design Requires:

- Specific B1 waveform
- Specific gradient waveforms

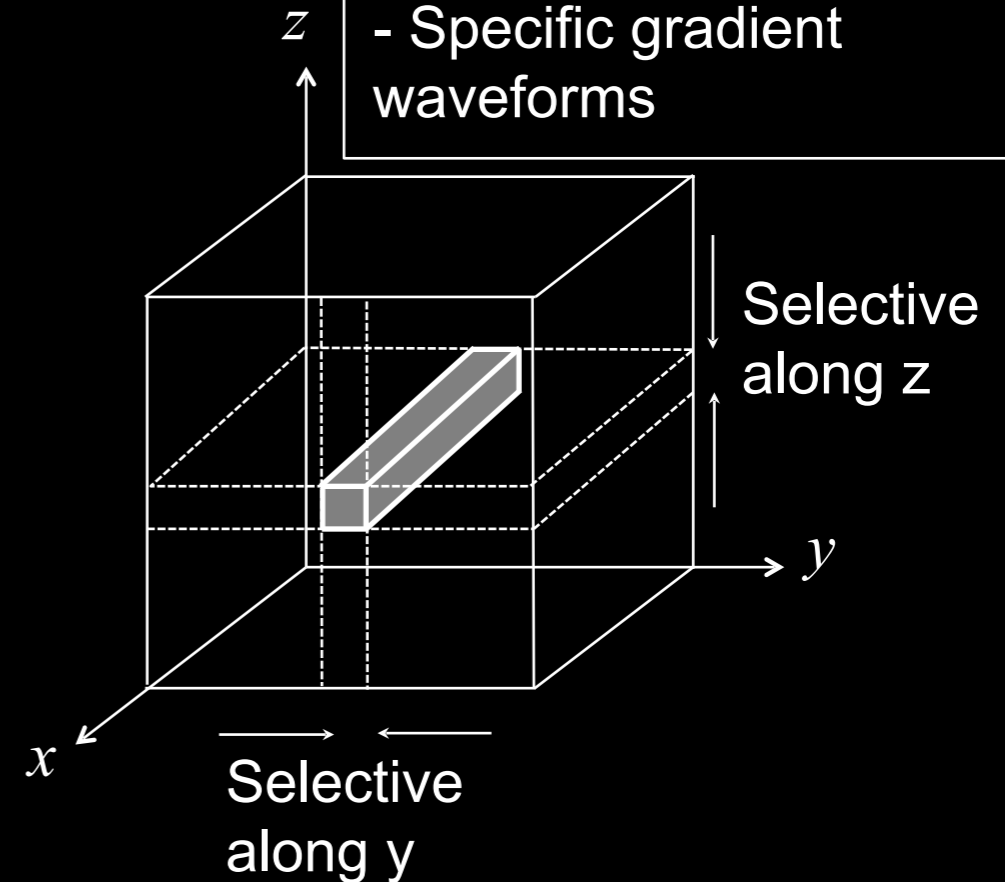

- 1D pulses are selective along 1 dimension, typically the slice select dimension
- 2D pulses are selective along 2 dimensions
 - So, a 2D pulse would select a long cylinder instead of a slice
 - The shape of the cross section depends on the 2D RF pulse

2D EPI Pulse Design

Designing EPI k-space Trajectory

- Ideally, an EPI trajectory scans a 2D raster in k-space

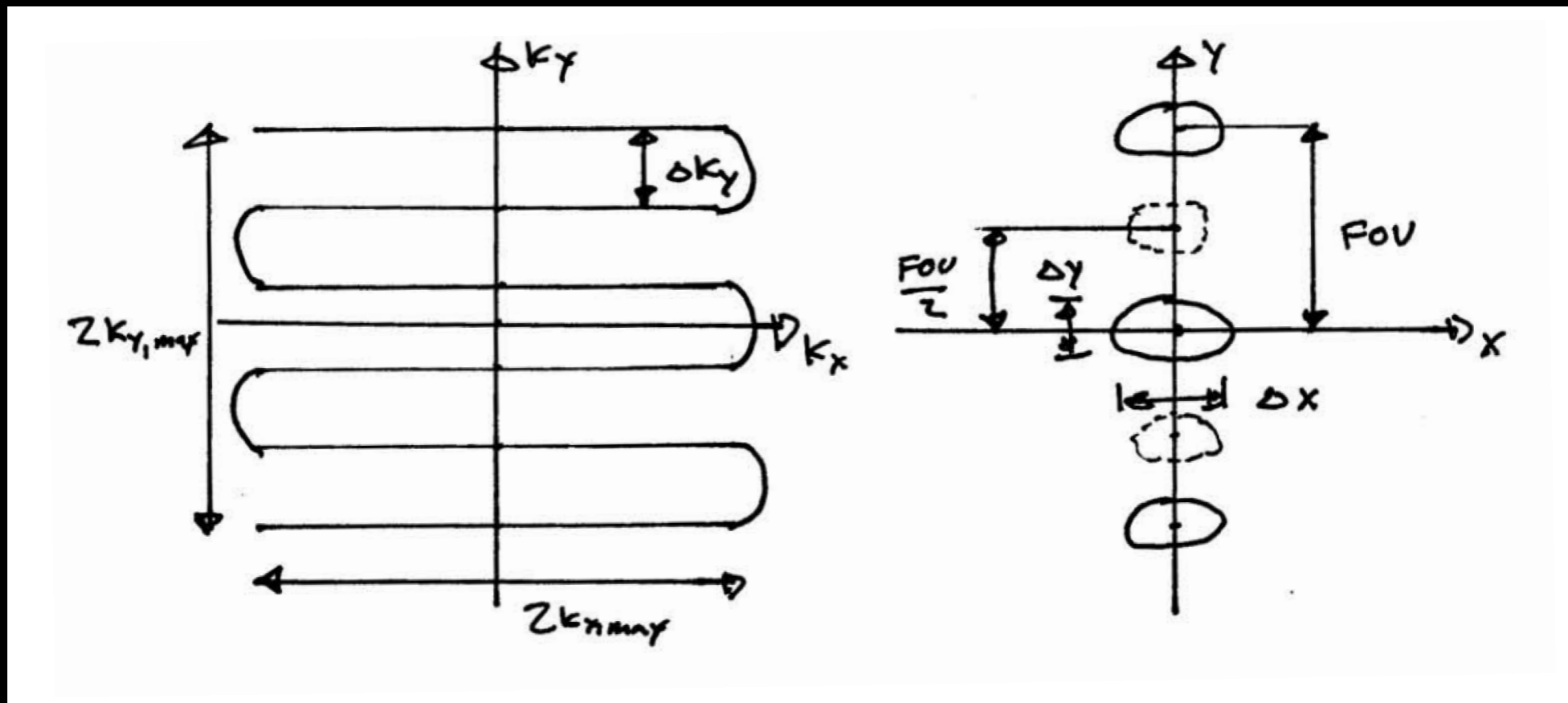

Resolution? / FOV?

Designing EPI k-space Trajectory

- Resolution: $\Delta x = \frac{TBW}{2k_{x,max}}$ $\Delta y = \frac{TBW}{2k_{y,max}}$

- FOV = $1/\Delta k_y$ $\Delta k_y = \frac{2k_{y,max}}{L-1}$

- Ghost FOV = FOV/2

- Eddy currents & delays produce this

Designing EPI k-space Trajectory

- Refocusing gradients
 - Returns to origin at the end of pulse
 - (Consider trajectory in excitation k-space)

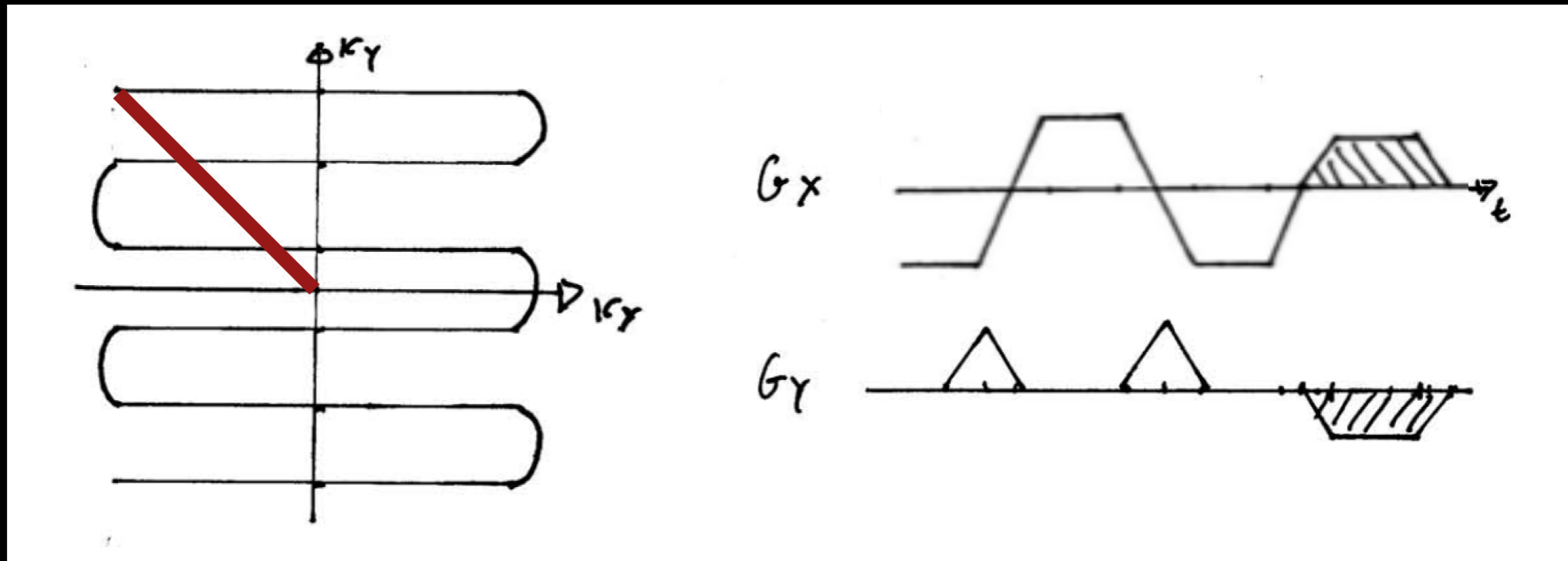

Designing EPI Gradients

- Designing readout lobes and blips
 - Flat-top only design

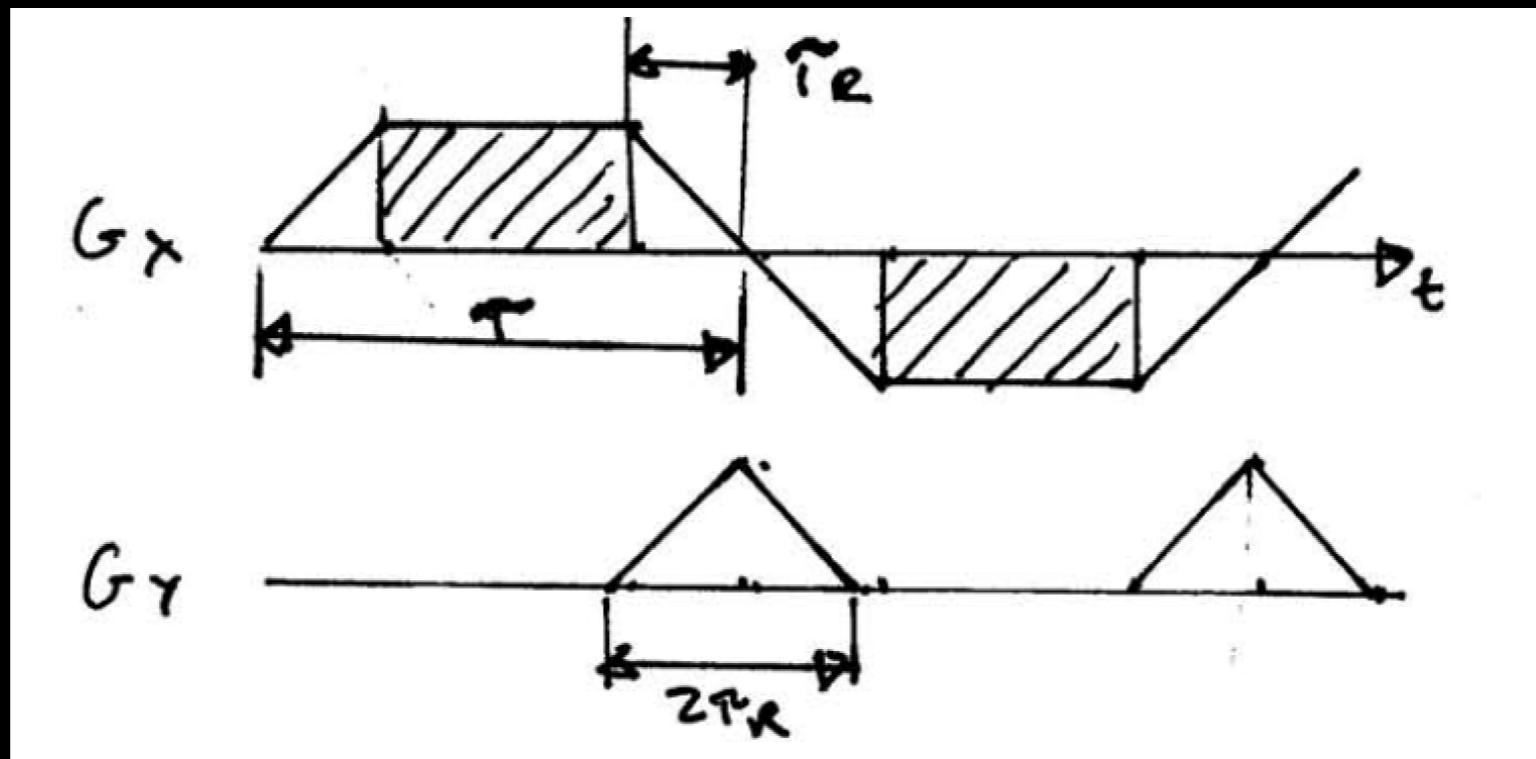

- RF only played during flat part (simpler)

To the board ...

Designing EPI Gradients

- Easy to get k-space coverage in k_y
- Hard to get k-space coverage in k_x
- We can get more k-space coverage by
 - making blips narrower
 - playing RF during part of ramps

Blipped EPI

- Rectilinear scan of k-space
- Most efficient EPI trajectory
- Common choice for spatial pulses
- Sensitive to eddy currents and gradient delays

Blipped EPI

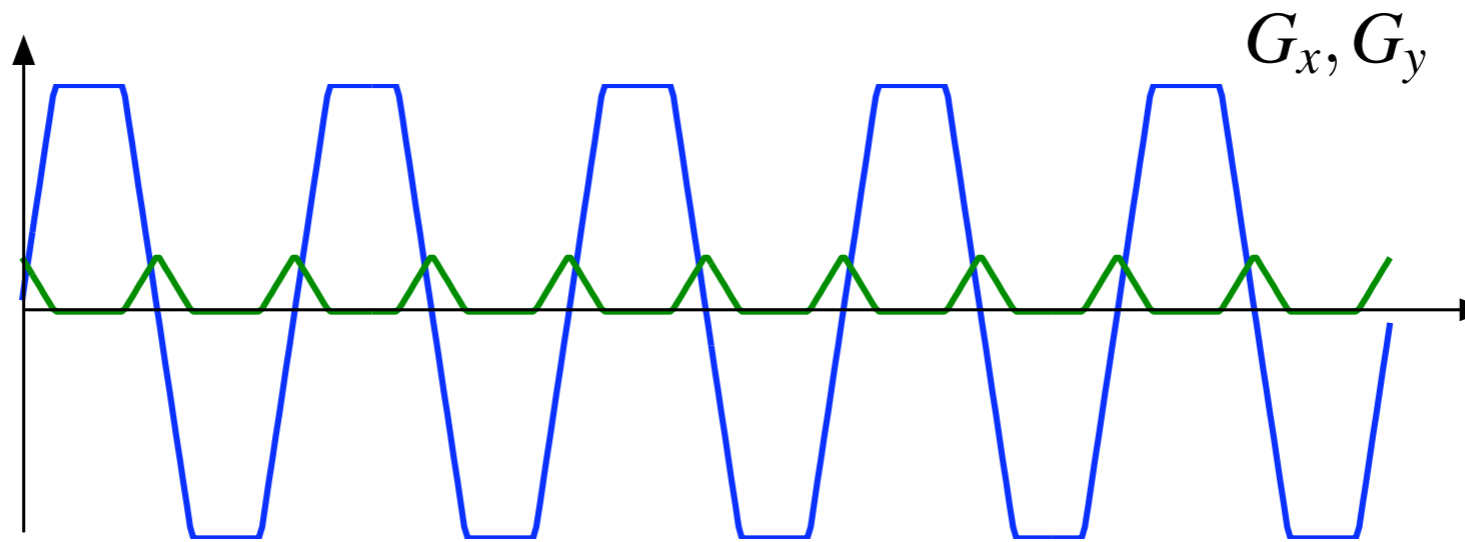

Gradient Waveforms

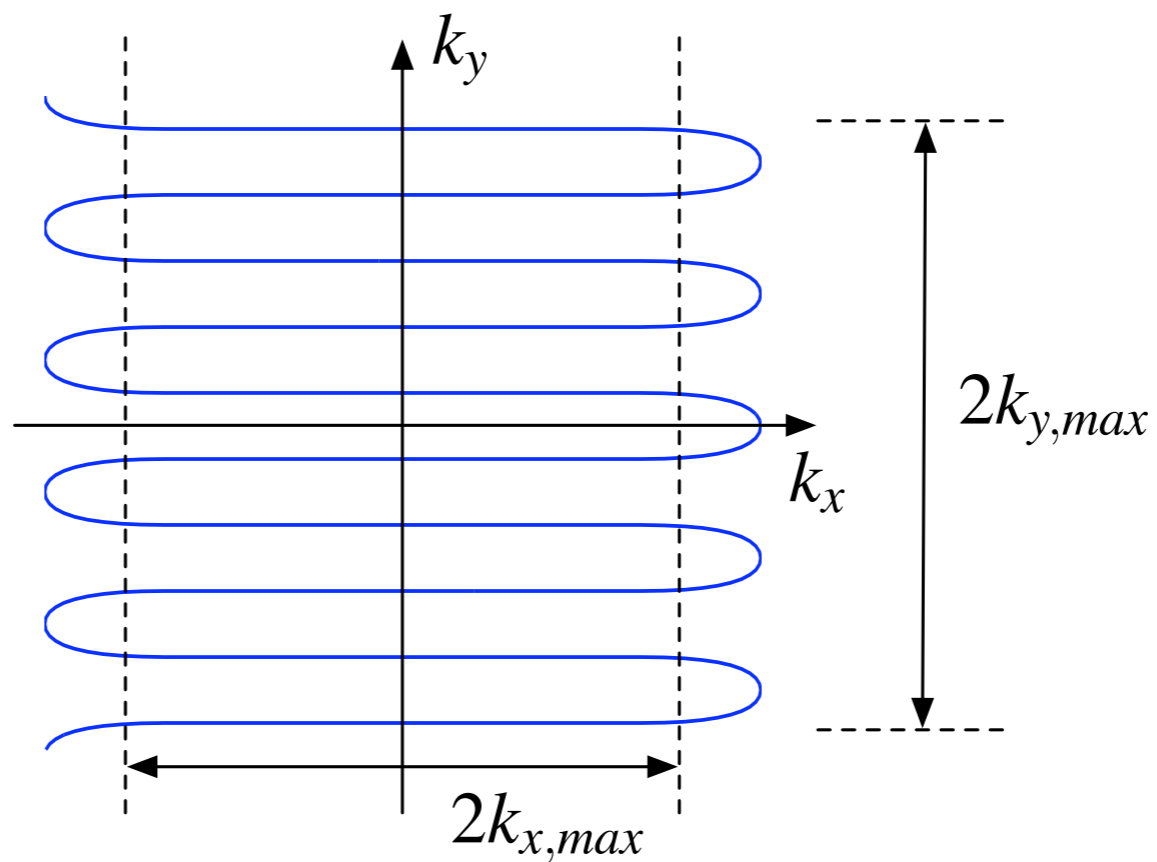

k-Space Trajectory

Continuous EPI

- Non-uniform k-space coverage
- Need to oversample to avoid side lobes
 - Less efficient than blipped
- Sensitive to eddy currents and gradient delays
 - Only choice for spectral-spatial pulses

Continuous EPI

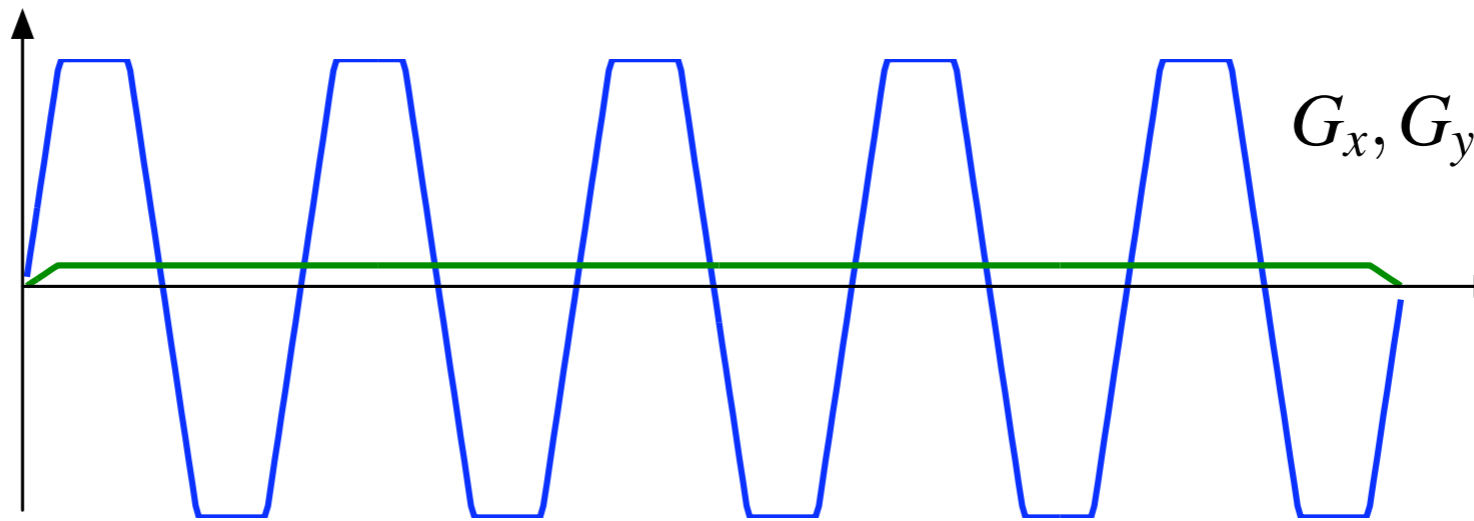

Gradient Waveforms

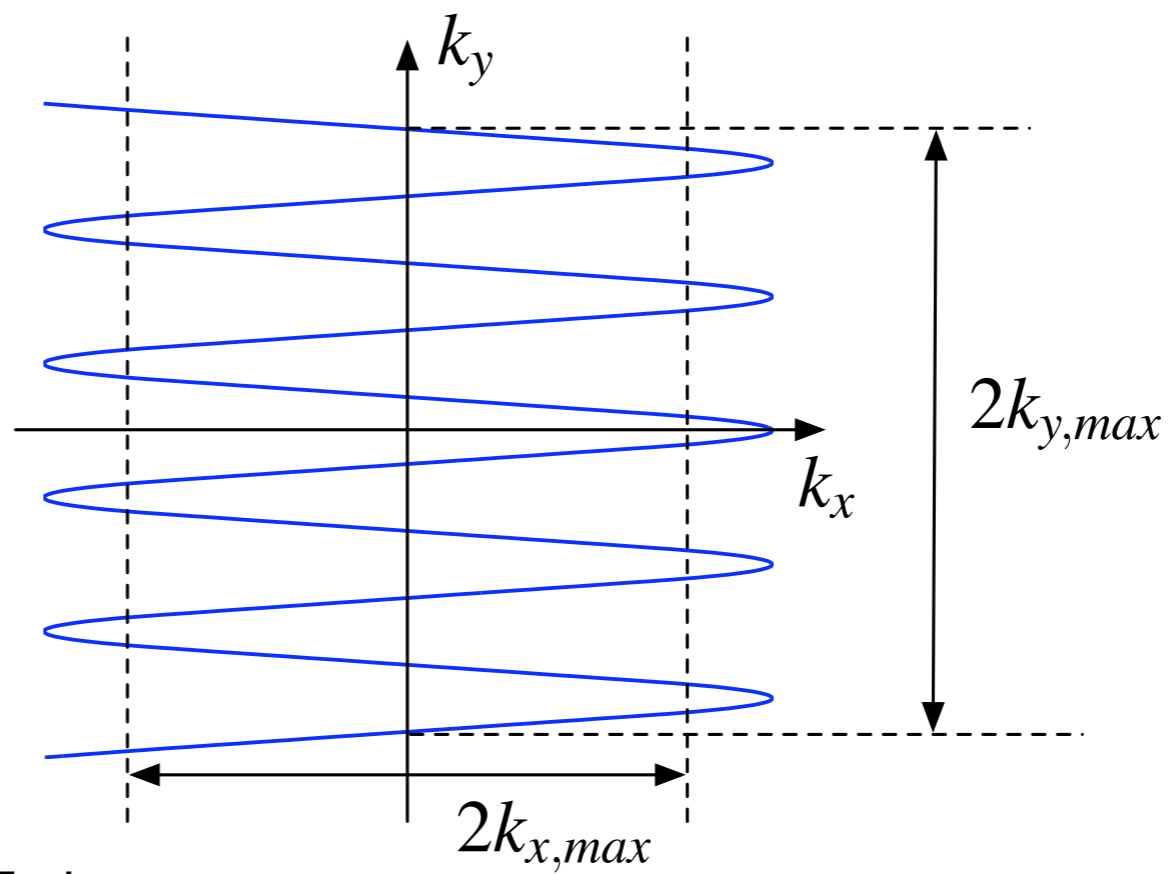

k -Space Trajectory

Flyback EPI

- Can be blipped or continuous
- Less efficient since retraces not used (depends on gradient system)
- Almost completely immune to eddy currents and gradient delays

Flyback EPI

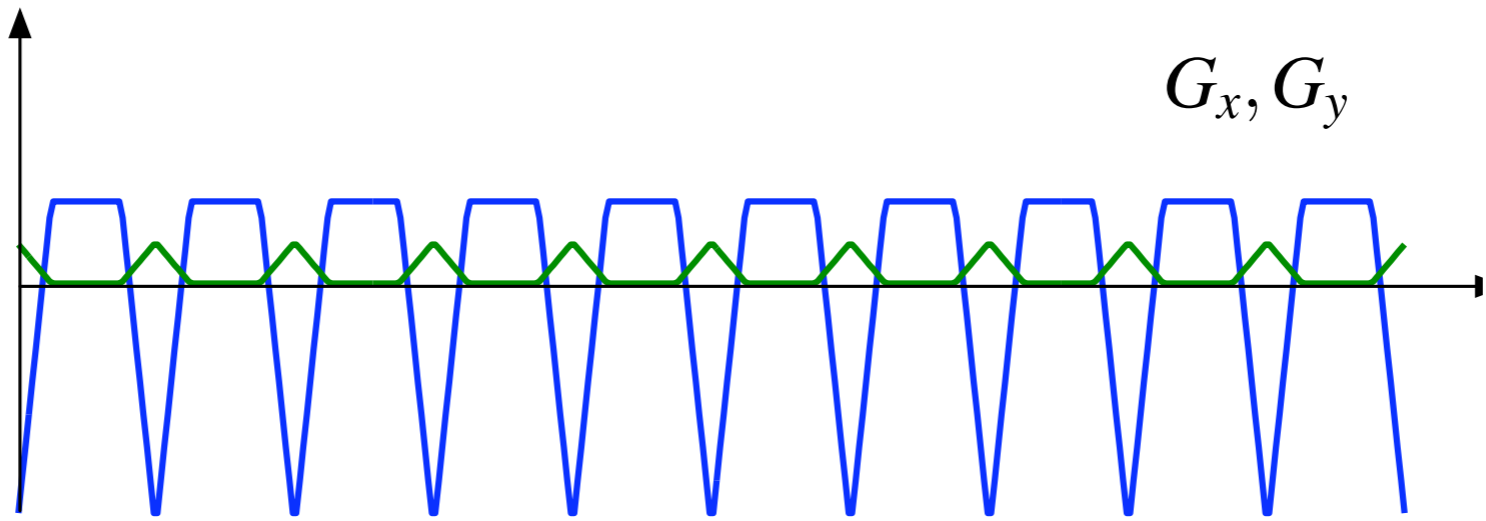

Gradient Waveforms

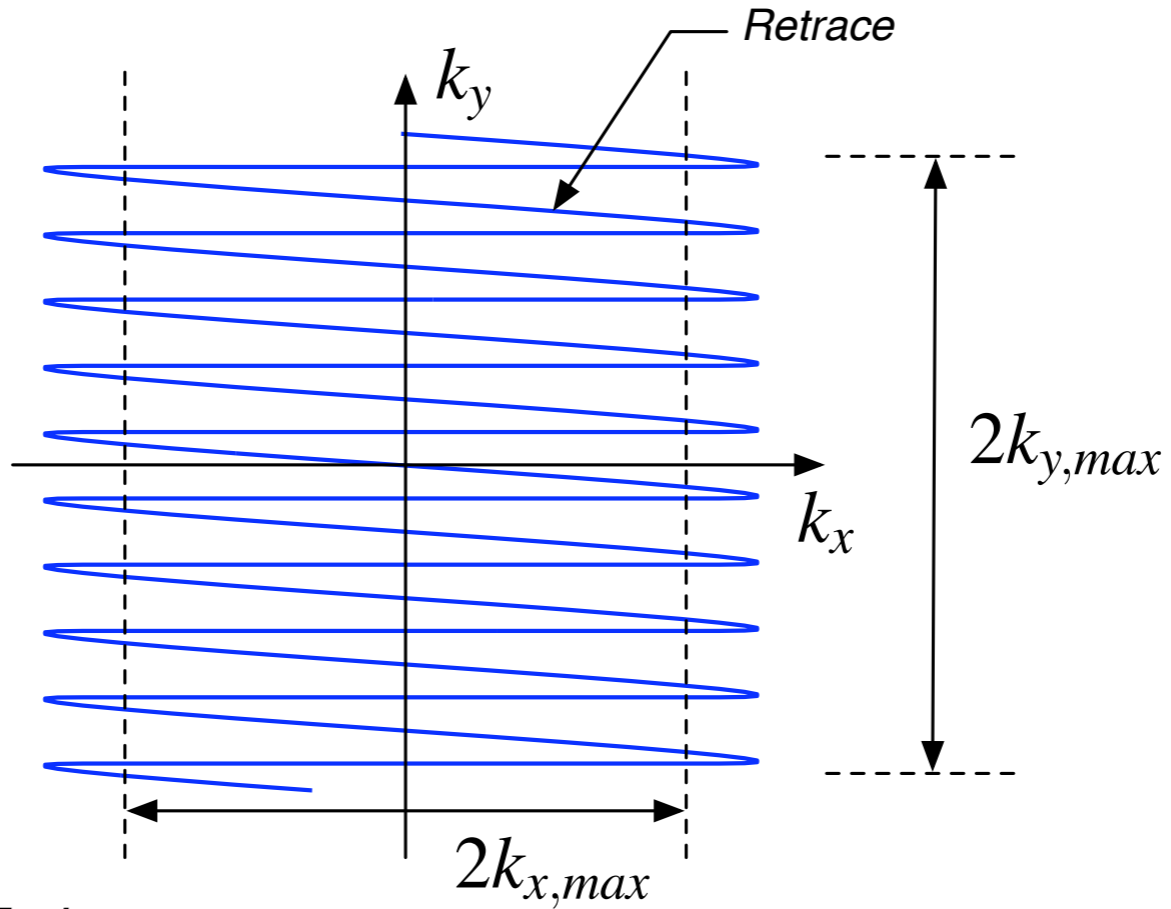

k-Space Trajectory

Designing 2D EPI Spatial Pulses

- Two major options
 - General approach, same as 2D spiral pulses
 - Separable, product design (easier)
- General approach
 - Choose EPI k-space trajectory
 - Design gradient waveforms
 - Design $W(k)$, k-space weighting
 - Design $B_1(t)$

Separable, Product Design

- Assume,

$$W(k_x, k_y) = A_F(k_x) \cdot A_S(k_y)$$

$A_S(k_y)$: weighting in the slow, blipped direction

$A_F(k_x)$: weighting in the fast oscillating direction

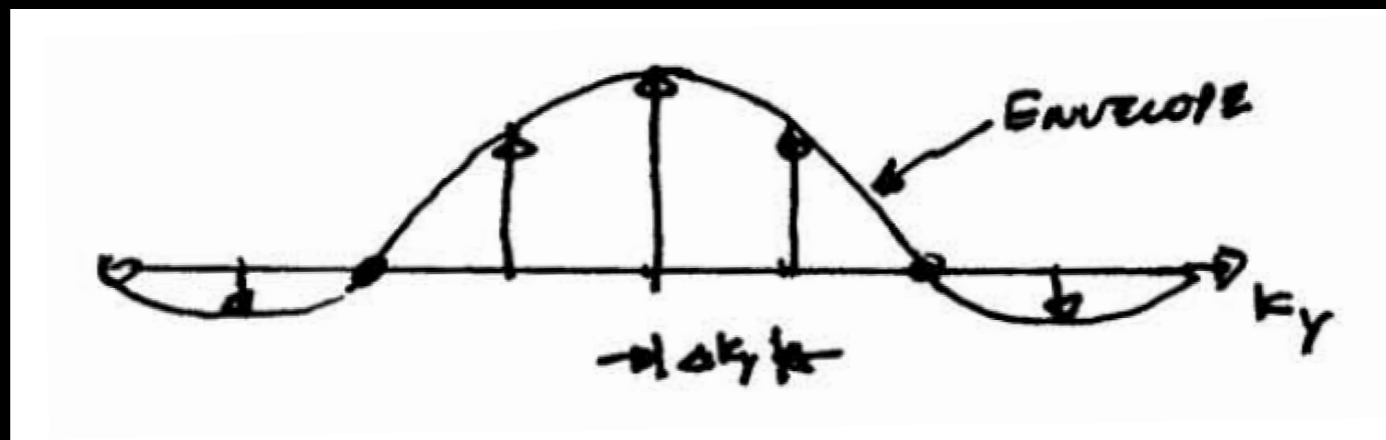

- Each impulse corresponds to a pulse in the fast direction, $A_F(k_x)$

Separable, Product Design

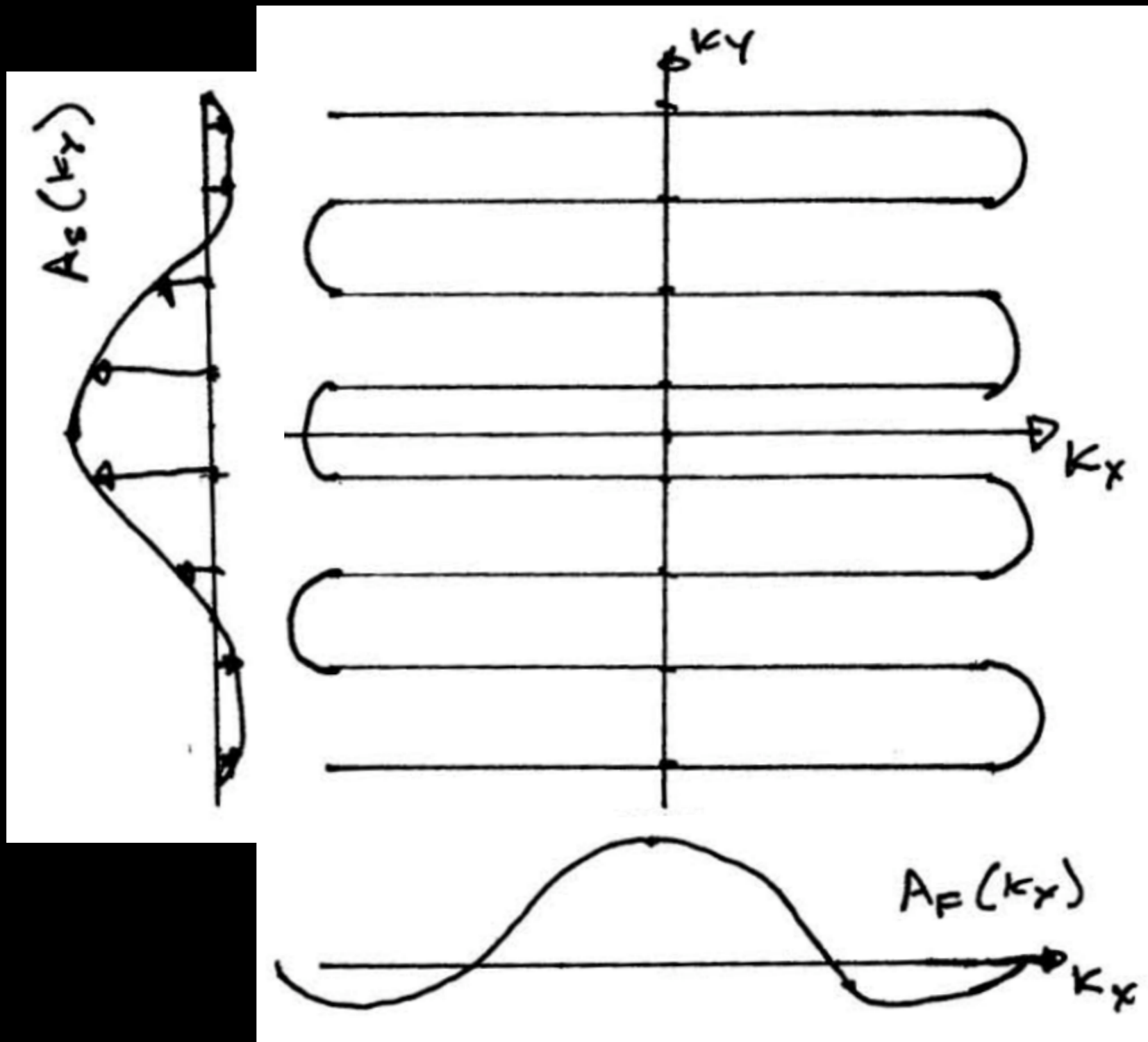

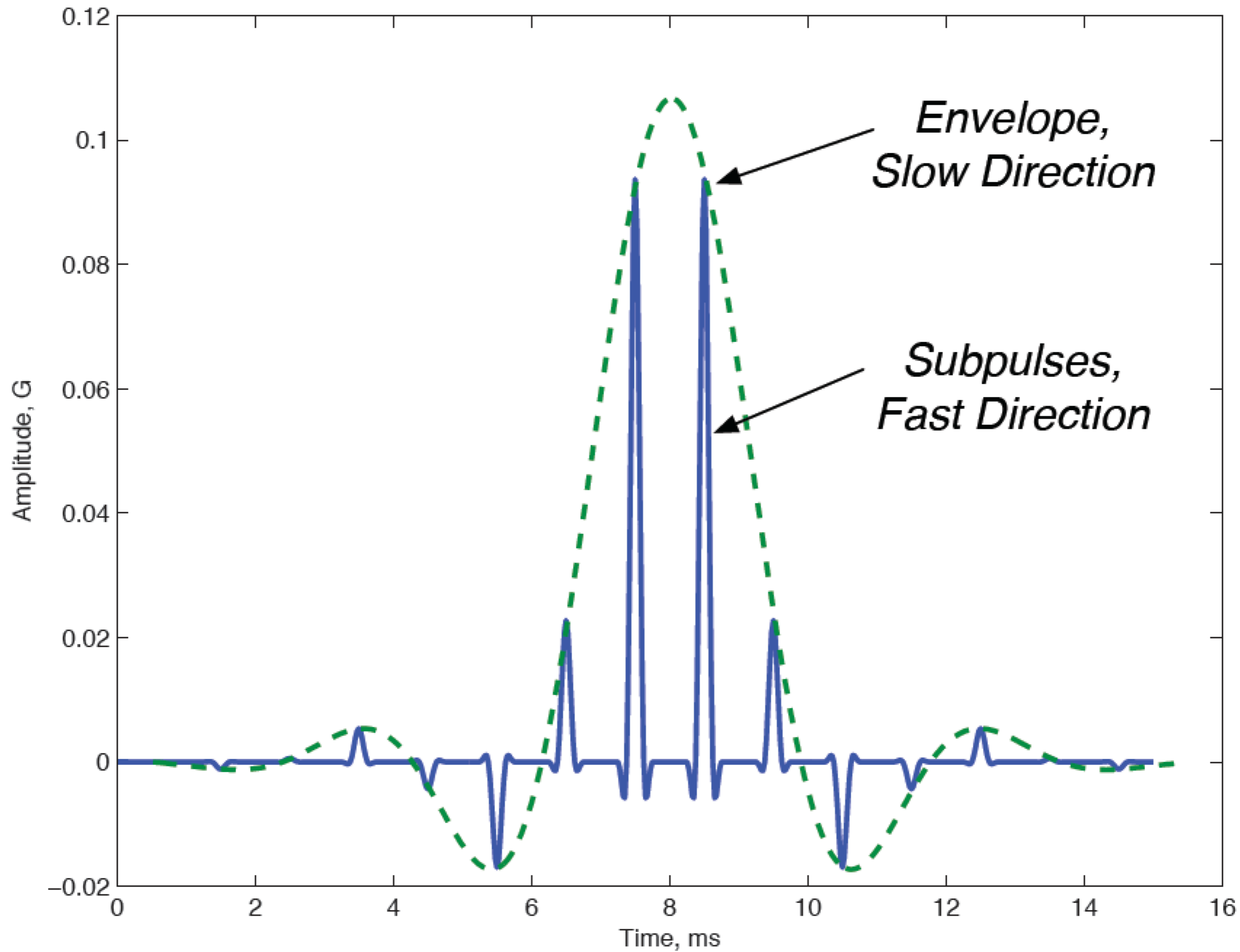

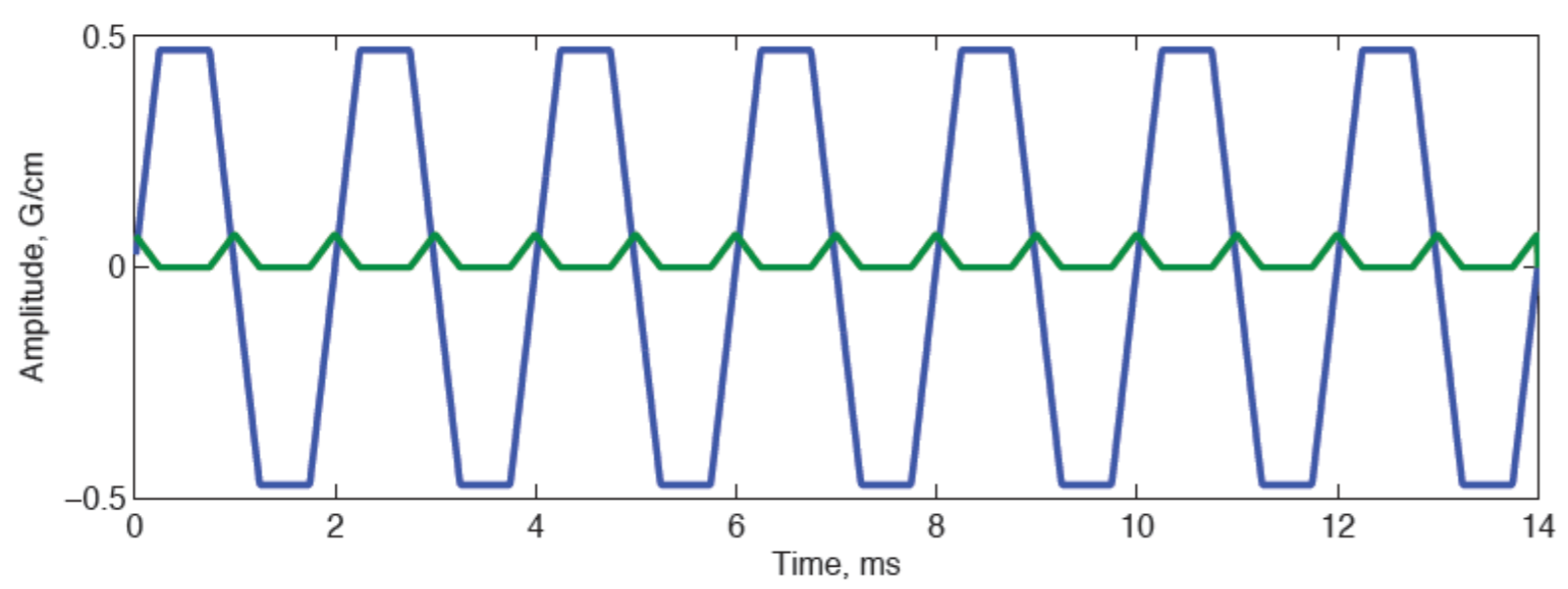
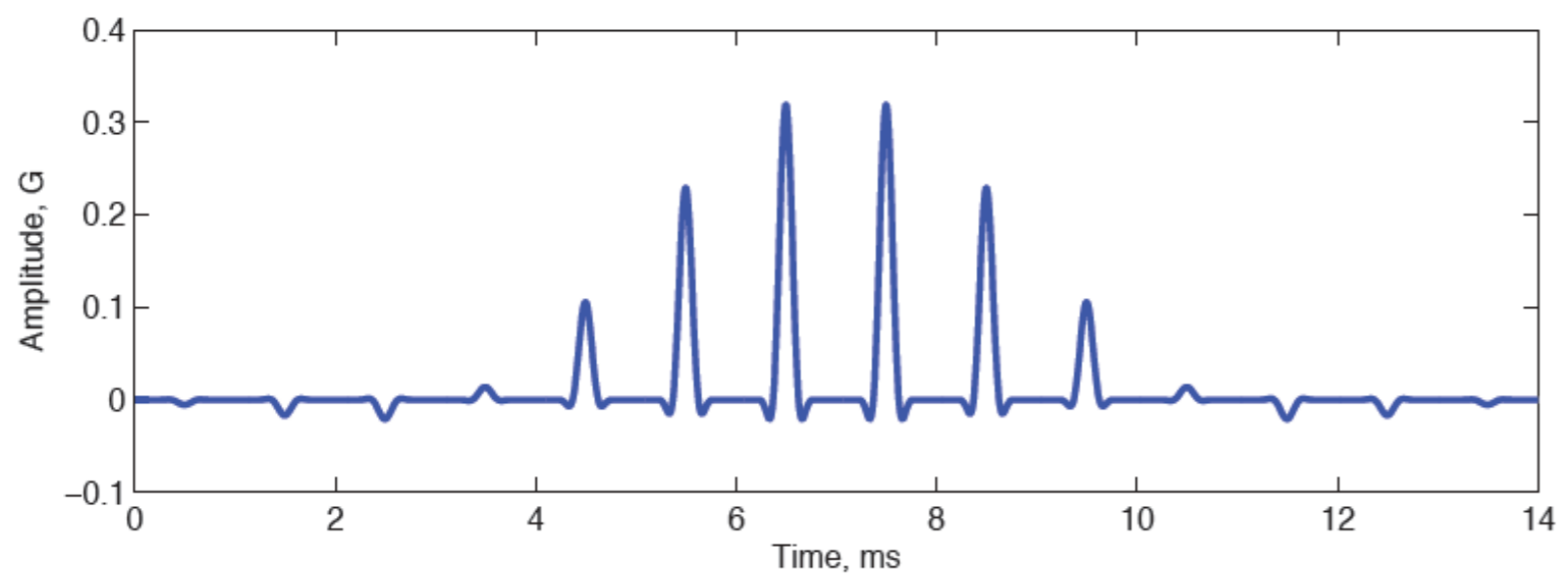

1 ms subpulses
14 subpulses
Flat top only (0.5 ms)
4 cm x 4 cm mainlobe
Sidelobes at +/- 13 cm

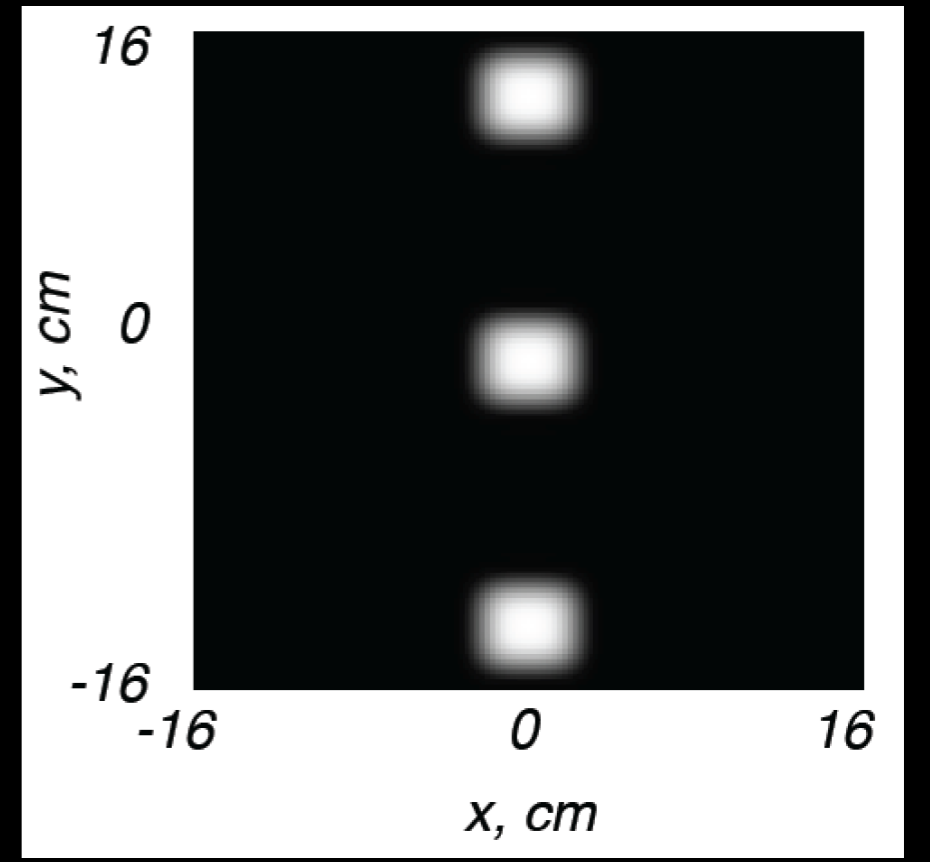

MATLAB Demo

Bloch Simulator

- <http://mrsrl.stanford.edu/~brian/blochsim/>

```
[mx,my,mz] = bloch(b1,gr,tp,t1,t2,df,dp,mode,mx,my,mz)
```

Bloch simulation of rotations due to B1, gradient and off-resonance, including relaxation effects. At each time point, the rotation matrix and decay matrix are calculated. Simulation can simulate the steady-state if the sequence is applied repeatedly, or the magnetization starting at m0.

INPUT:

b1 = (Mx1) RF pulse in G. Can be complex.
gr = (Mx1,2,or 3) 1,2 or 3-dimensional gradient in G/cm.
tp = (Mx1) time duration of each b1 and gr point, in seconds,
or 1x1 time step if constant for all points
or monotonically INCREASING endtime of each
interval..
t1 = T1 relaxation time in seconds.
t2 = T2 relaxation time in seconds.
df = (Nx1) Array of off-resonance frequencies (Hz)
dp = (Px1,2,or 3) Array of spatial positions (cm).
Width should match width of gr.
mode= Bitmask mode:
Bit 0: 0-Simulate from start or M0, 1-Steady State
Bit 1: 1-Record m at time points. 0-just end time.

Windowed Sinc RF Pulse

```
%% Design of Windowed Sinc RF Pulses
```

```
tbw = 4;
```

```
samples = 512;
```

```
rf = wsinc(tbw, samples);
```

```
function h = wsinc(tbw, ns)
```

```
% rf = wsinc(tbw, ns)
```

```
%
```

```
%   tbw   --   time bandwidth product
```

```
%   ns    --   number of samples
```

```
%   h     --   windowed sinc function, normalized so that sum(h) = 1
```

```
xm = (ns-1)/2;
```

```
x = [-xm:xm]/xm;
```

```
h = sinc(x*tbw/2) .* (0.54+0.46*cos(pi*x));
```

```
h = h/sum(h);
```

RF Pulse Scaling

```
%% Plot RF Amplitude
```

```
rf = (pi/2)*wsinc(tbw,samples);
```

```
pulseduration = 1; %ms
```

```
rfs = rfscalerf(rf, pulseduration); % Scaled to Gauss
```

$$\theta = \int_0^{\tau} \gamma B_1(s) ds$$

$$\theta_i = \gamma B_1(t_i) \Delta t$$

$$B_1(t_i) = \frac{1}{\gamma \Delta t} \theta_i$$

RF Pulse Scaling

```
%% Plot RF Amplitude
```

```
rf = (pi/2)*wsinc(tbw,samples);
```

```
pulseduration = 1; %ms
```

```
rfs = rfscaleg(rf, pulseduration); % Scaled to Gauss
```

```
function rfs = rfscaleg(rf,t) 
```

```
% rfs = rfscaleg(rf,t)
```

```
%
```

```
% rf -- rf waveform, scaled so sum(rf) = flip angle
```

```
% t -- duration of RF pulse in ms
```

```
% rfs -- rf waveform scaled to Gauss
```

```
%
```

```
gamma = 2*pi*4.257; % kHz*rad/G
```

```
dt = t/length(rf);
```

```
rfs = rf/(gamma*dt);
```

Bloch Simulation

```
%% Simulate Slice Profile
tbw = 4;
samples = 512;

rf = (pi/2)*wsinc(tbw,samples);
pulseduration = 1; %ms

rfs = rfscalg(rf, pulseduration); % Scaled to Gauss
b1 = [rfs zeros(1,samples/2)]; % in Gauss
g = [ones(1,samples) -ones(1,samples/2)]; % in G/cm

x = (-4:.1:4); % in cm
f = (-250:5:250); % in Hz
dt = pulseduration/samples/1e3;
t = (1:length(b1))*dt; % in usec

% Bloch Simulation
[mx,my,mz] = bloch(b1,g,t,1,.2,f,x,0);
mxy=mx+1i*my;
```

Bloch Simulation

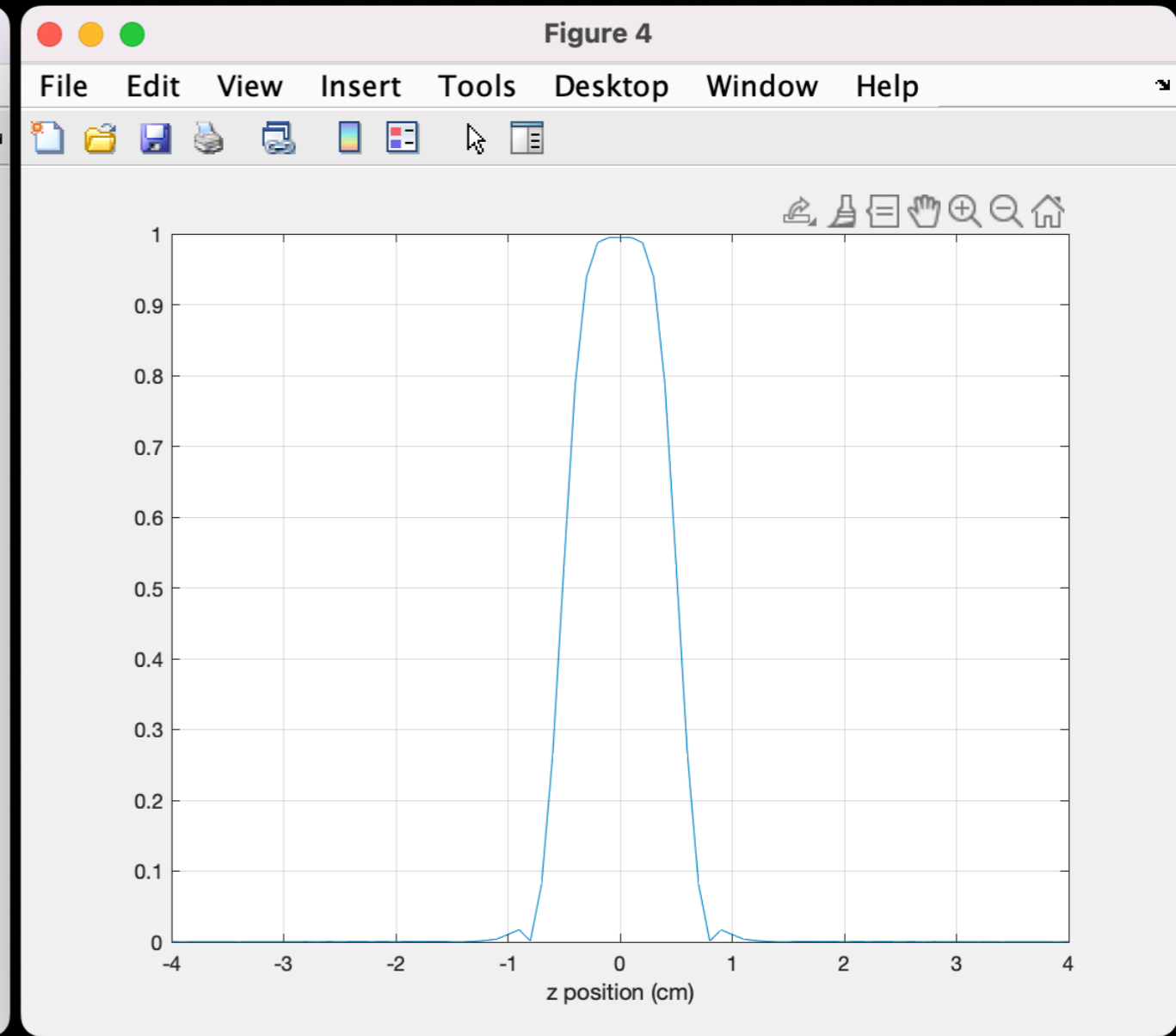
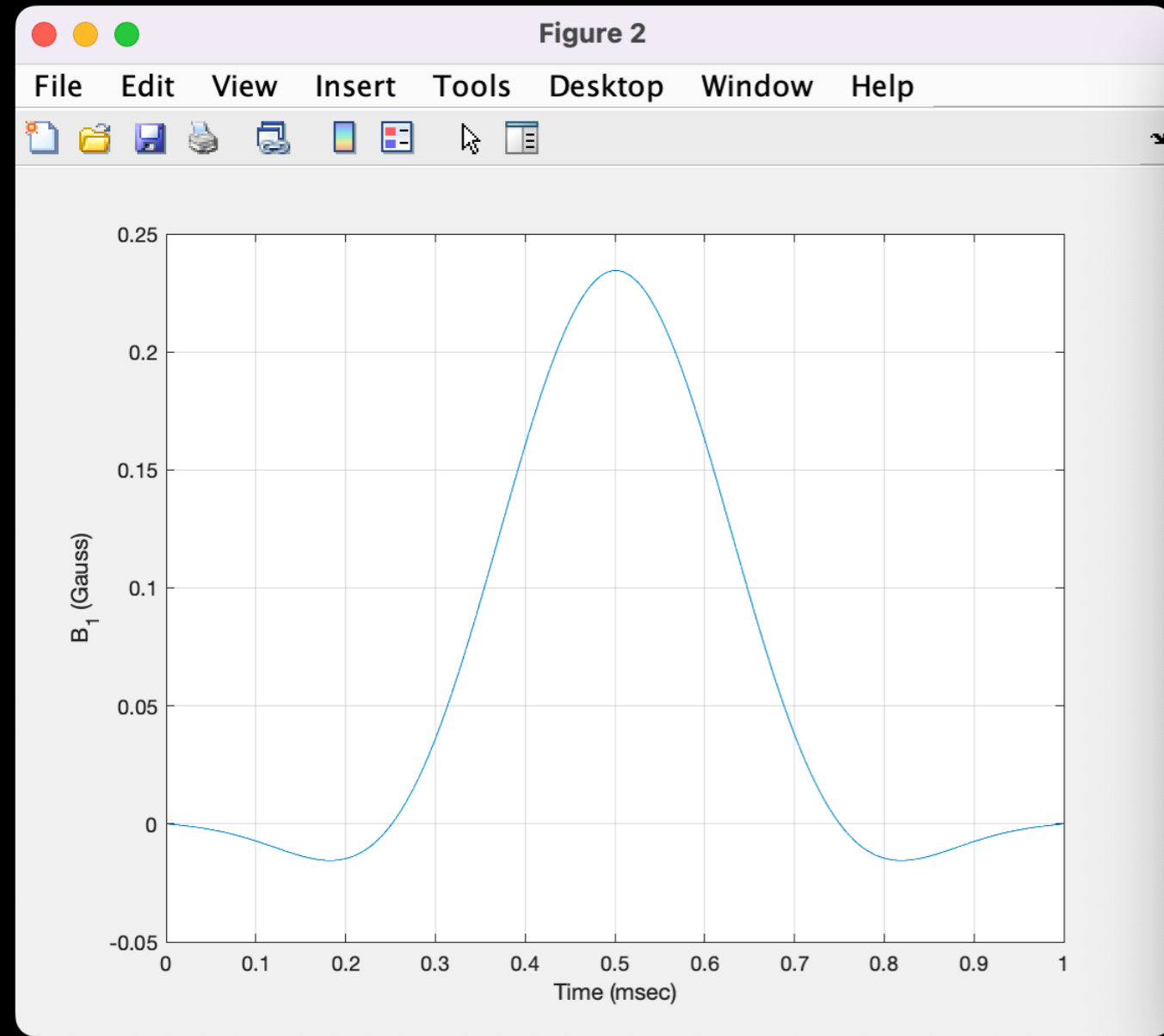

Thank You!

- Further reading
 - Read “Spatial-Spectral Pulses” p.153-163
- Acknowledgments
 - John Pauly’s EE469B (RF Pulse Design for MRI)
 - Shams Rashid
 - Kyung Sung

Holden H. Wu, PhD
HoldenWu@mednet.ucla.edu
<https://mrrl.ucla.edu/wulab>