

# Quantitative Cardiovascular Flow Imaging

Mike Loecher, Ph.D.

Magnetic Resonance Research Labs



David Geffen  
School of Medicine

**UCLA**  
*Radiology*

# Encoding Motion

- **Coherent Motion**
  - Coherent at a scale  $\geq$ pixel
  - Spin (tissue) displacement and velocity
  - Example: Phase Contrast MRI (PC-MRI)
- **Incoherent Motion**
  - Incoherent at a scale  $<$ pixel
  - Spin perfusion and diffusion
  - Example: Diffusion Weighted MRI (DWI)

# PC-MRI Overview

# PC-MRI

Encode velocity into image phase

# Phase Contrast MRI

- **PC-MRI can quantify blood flow:**
  - Peak velocity [cm/s]
  - Transvalvular forward flow [mL]
    - Regurgitant volumes [mL]
  - Pulmonary-Systemic Flow Ratio
    - $Q_P/Q_S$
  - Right-Left Lung Flow Ratio
    - $Q_{RPA}/Q_{LPA}$

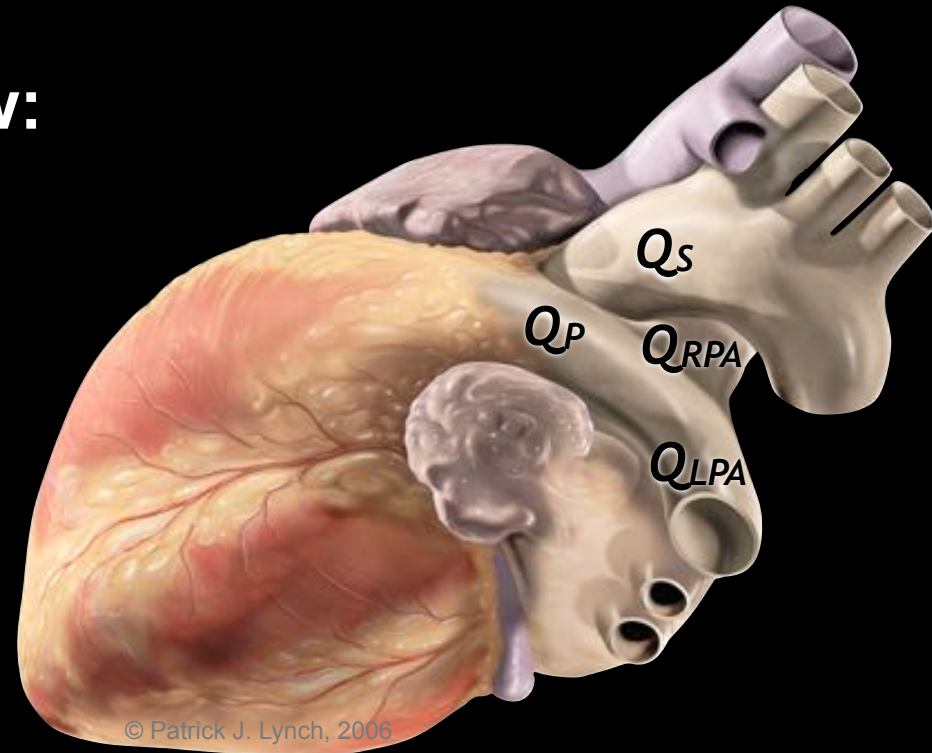

***What is the peak aortic velocity?***

***What is the right/left lung flow ratio?***

***Is the pulmonary to systemic flow ratio ( $Q_p/Q_s$ ) normal?***

# SIGNIFICANCE

- **The evaluation of CHD patients is enhanced by accurate quantification of blood flow:**
  - Peak velocity
  - Transvalvular forward flow
  - Regurgitant volumes
  - $Q_p/Q_s$  and Right/Left lung flow
- **CHD patients require frequent monitoring of cardiac functional status**
  - Lifetime of radiological exams
  - Elevated cumulative exposure to ionizing radiation

# SIGNIFICANCE

- **Catheterization**
  - **Disadvantages:**
    - **Ionizing radiation**
    - **Invasive**
    - **Indirect quantification of flow**
- **Echocardiography**
  - **Disadvantages:**
    - **Limited acoustic windows**
    - **Vessel angulation relative to the transducer**
    - **Complex cardiovascular anatomy in CHD patients**

# SIGNIFICANCE

- **PC-MRI is useful for measuring flow in CHD patients**
  - **Non-invasive**
  - **Direct quantification of velocity & flow**
  - **Reduced lifetime radiation exposure**
- **Higher accuracy and clinical confidence in PC-MRI**
  - **More effective management of patients with CHD**



# Phase Contrast Applications

- **Quantify blood flow**
  - Peak velocity & volume of flow,
  - Shear stress
- **Measure CSF flow**
- **Cardiac motion estimation**

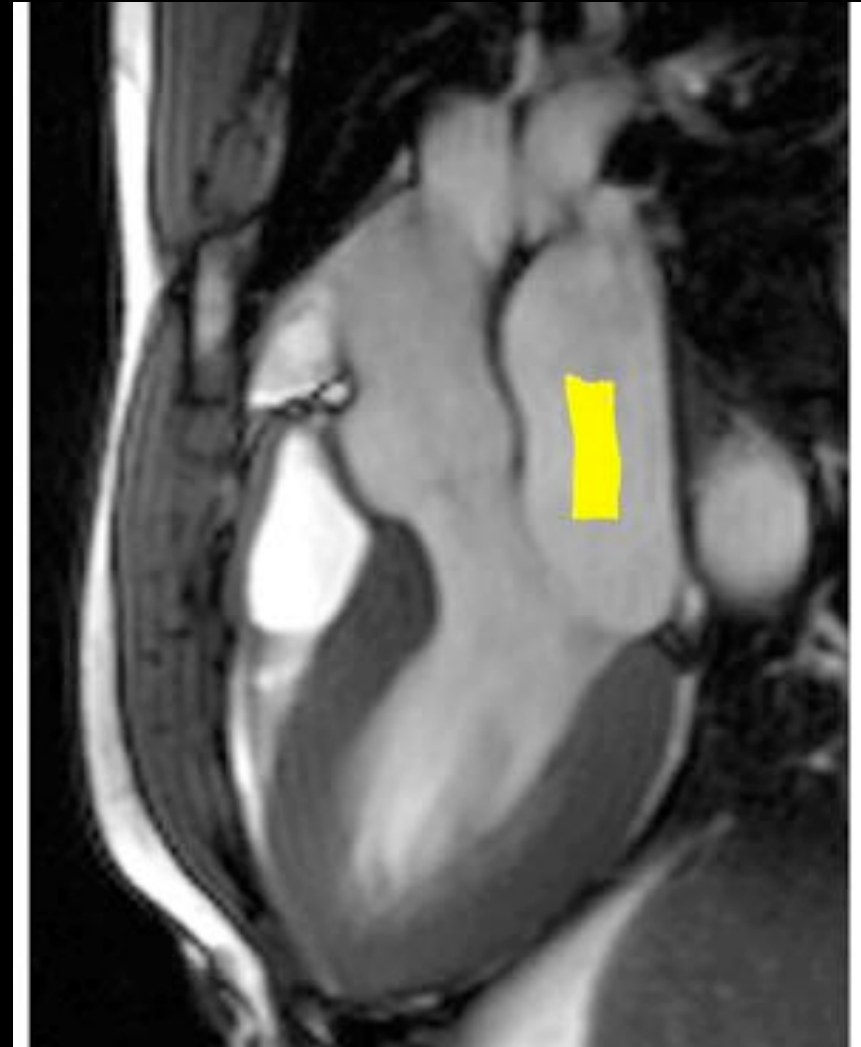

# Phase Contrast

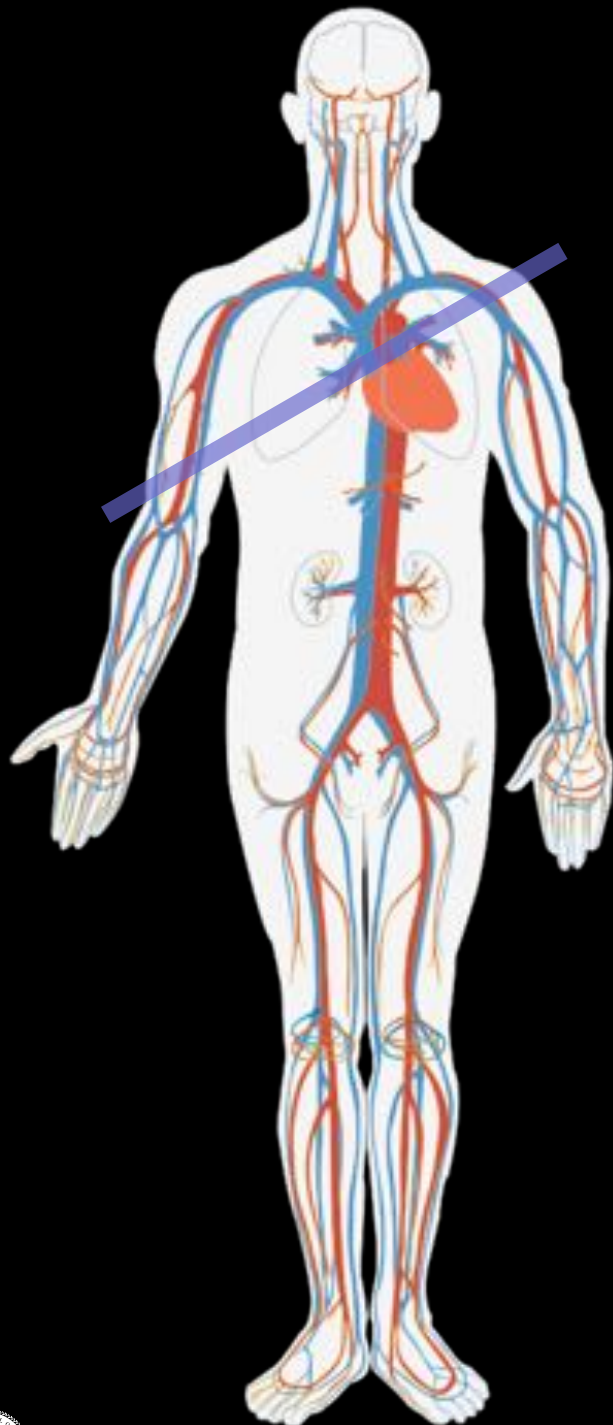

Magnitude Image

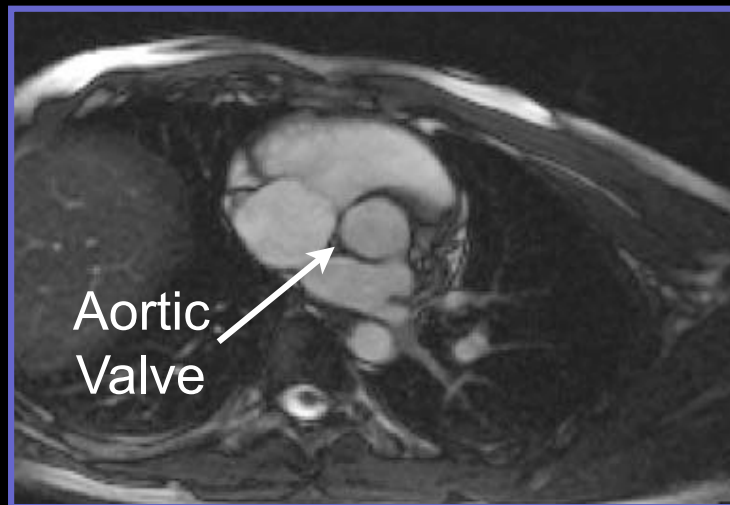

Phase Image

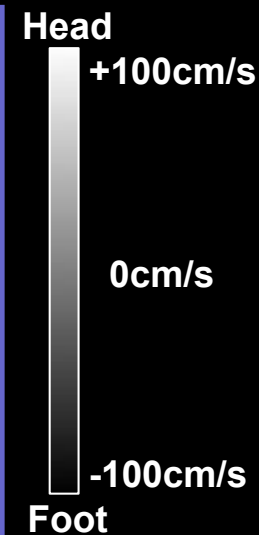
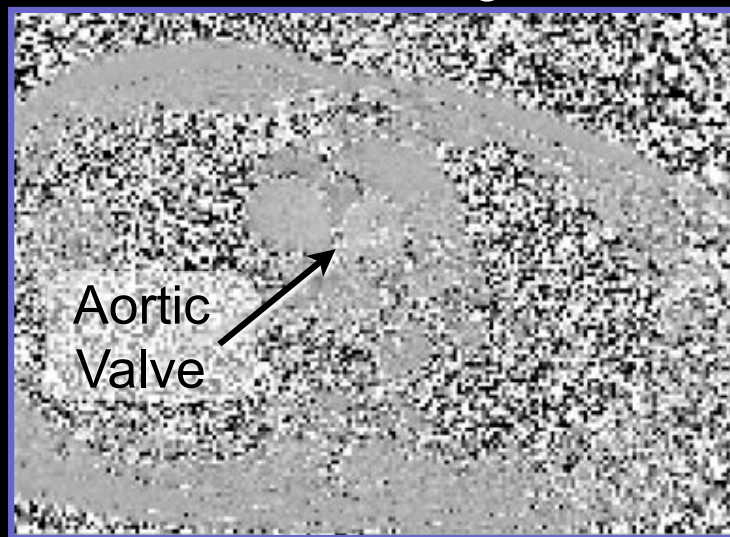

# Phase Contrast Analysis

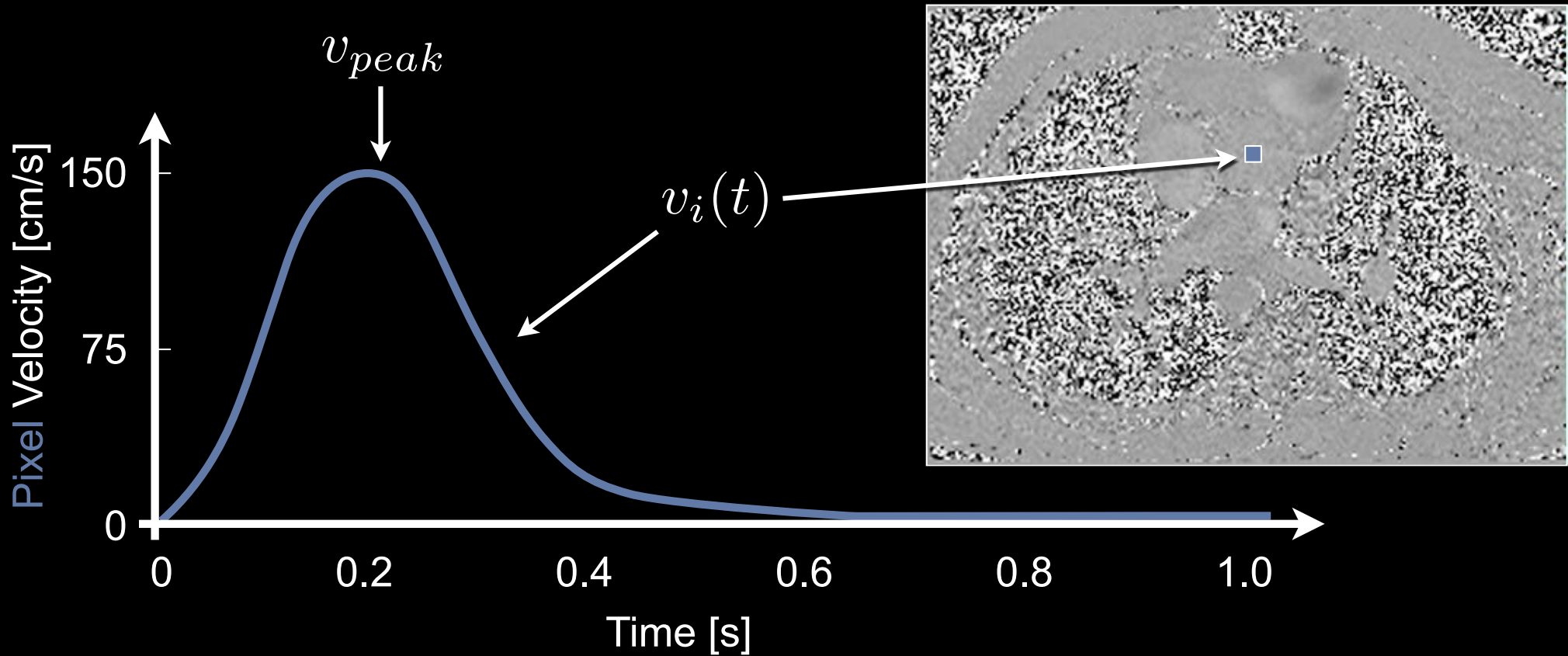

$$\vec{v}_i(t) \cdot \vec{A}_i(t)$$

$$[\text{cm/s}] \quad [\text{cm}^2]$$

Pixel Flow Rate

$$[\text{mL/s}]$$

# Phase Contrast Analysis

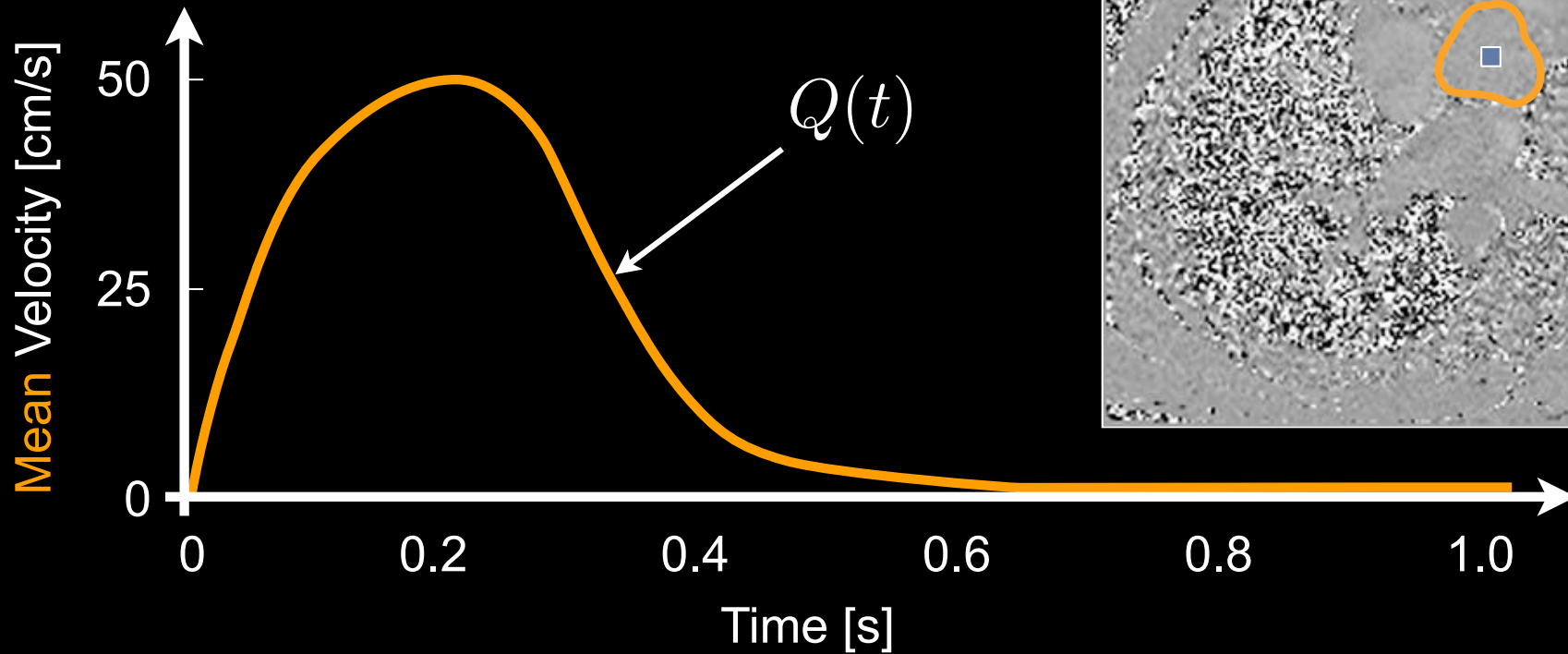

$$\dot{V}(t) = Q(t) = \sum_{i=1}^{n_{ROI}} \vec{v}_i(t) \cdot \vec{A}_i(t)$$

Volume Flow Rate [mL/s]

# Phase Contrast Analysis

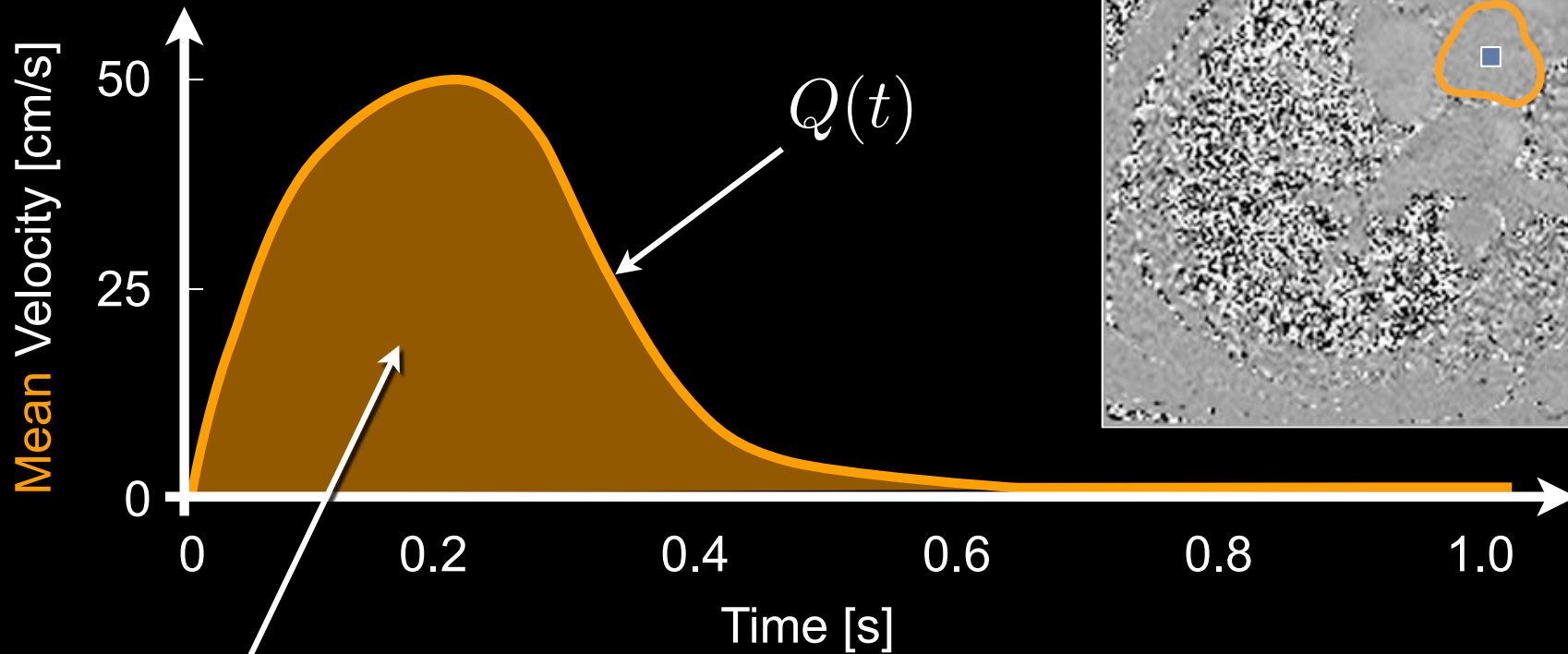

$$Q = \int \left( \sum_{i=1}^{n_{ROI}} \vec{v}_i(t) \cdot \vec{A}_i(t) \right) dt \quad \text{Forward Flow [mL]}$$

How do we acquire cardiac movies?

# Conventional Segmented Imaging

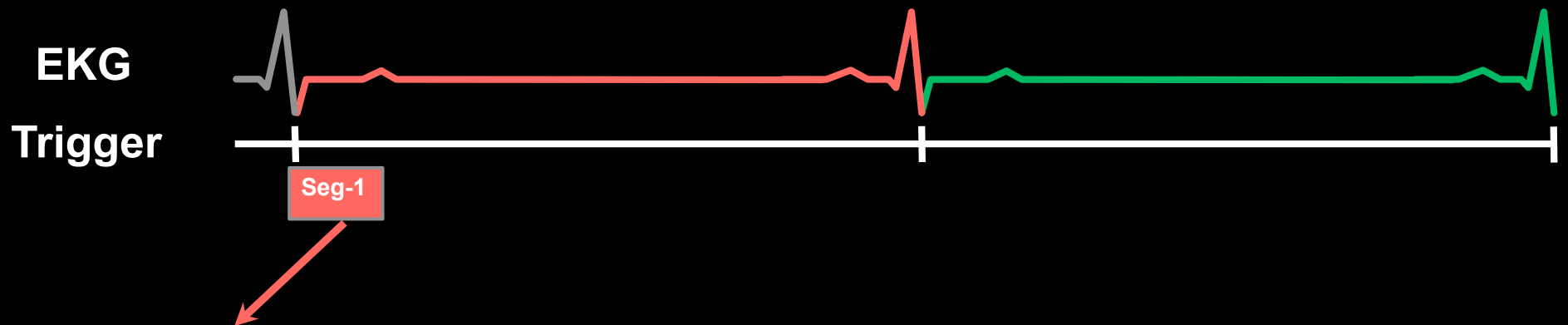

$$t_{\text{Segment}} = TR \cdot N_{k_y} = 8\text{ms} \cdot 6 = 48\text{ms}$$

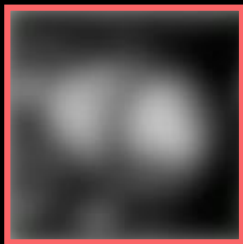

# Conventional Segmented Imaging

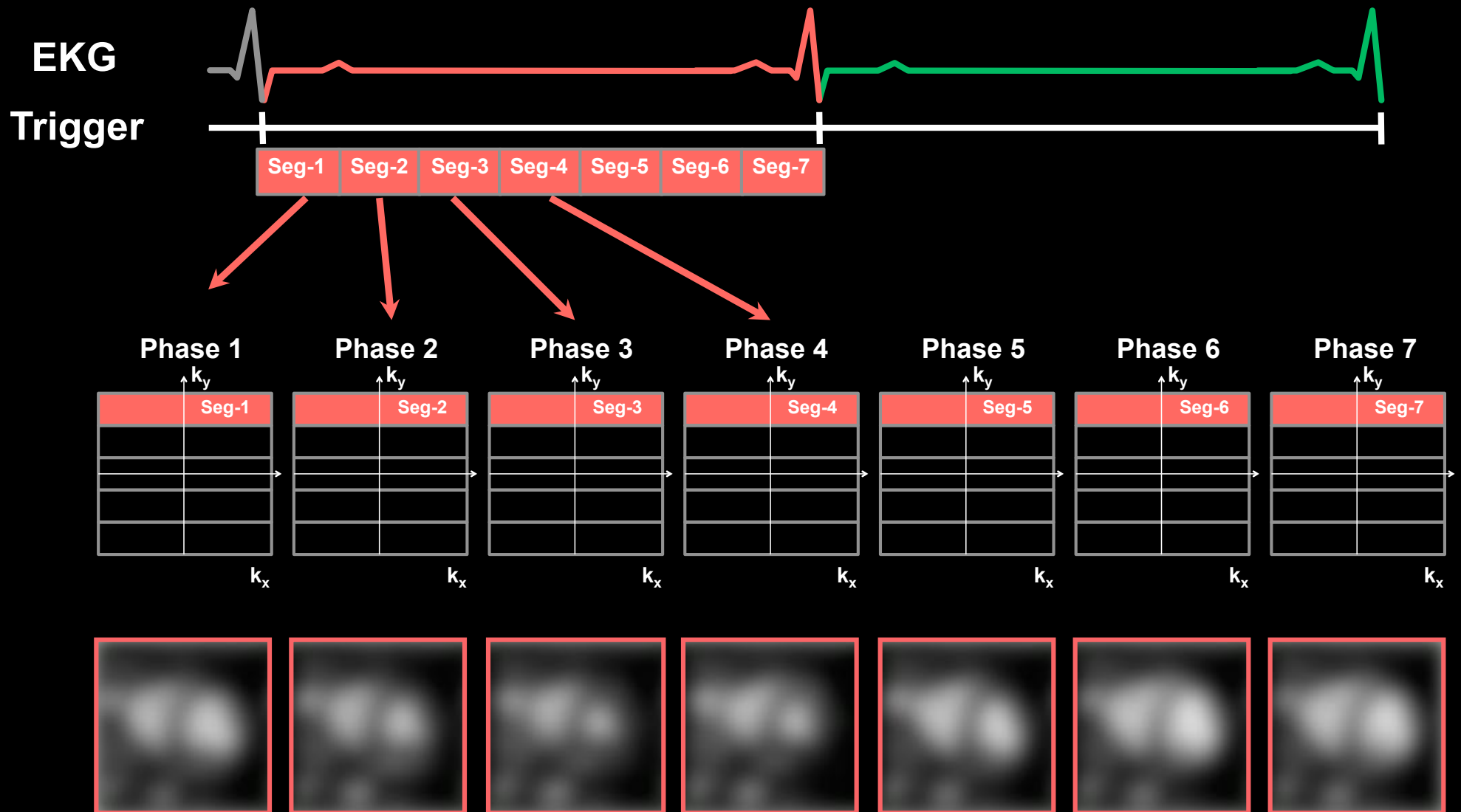



# Conventional Segmented Imaging

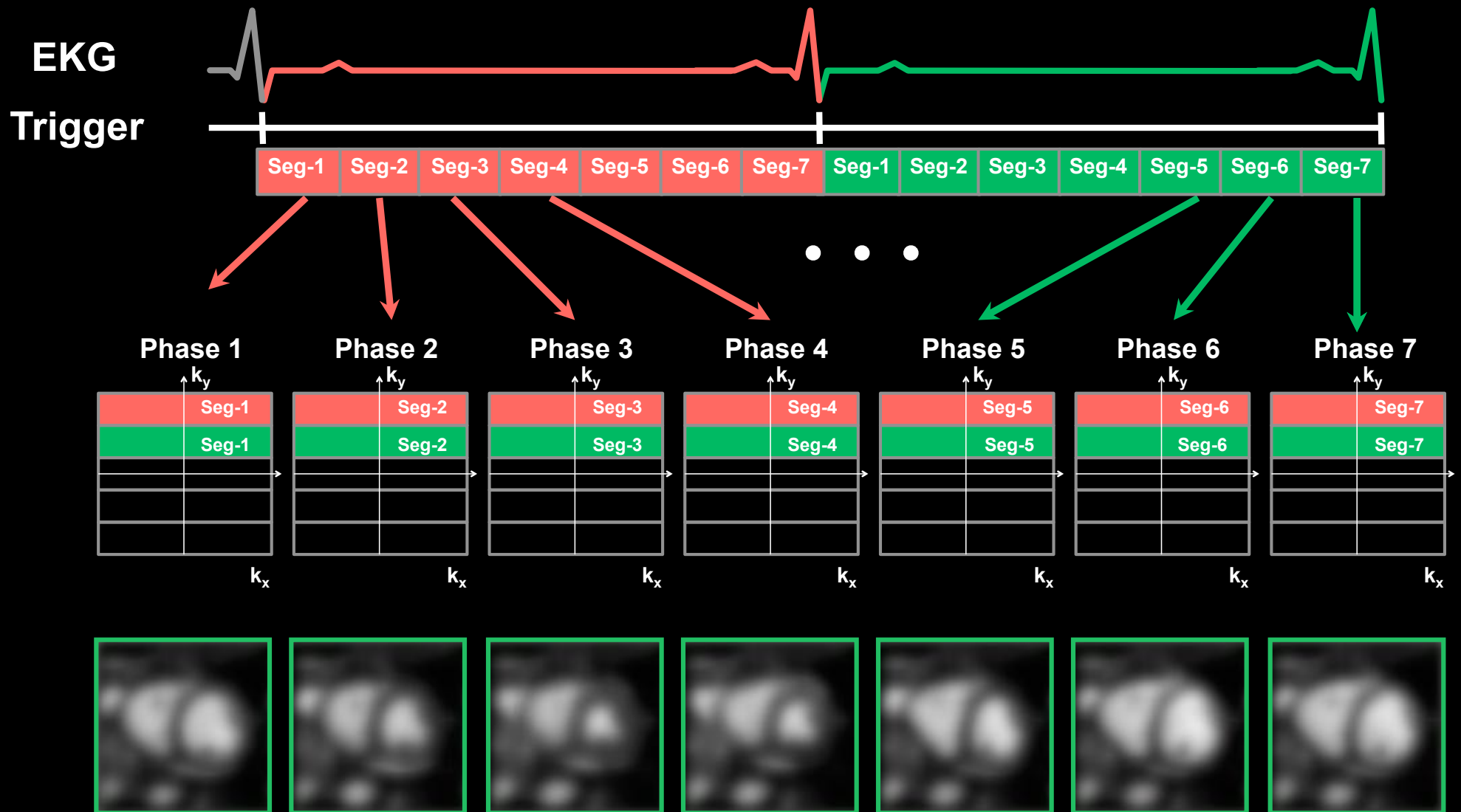

# Conventional Segmented Imaging

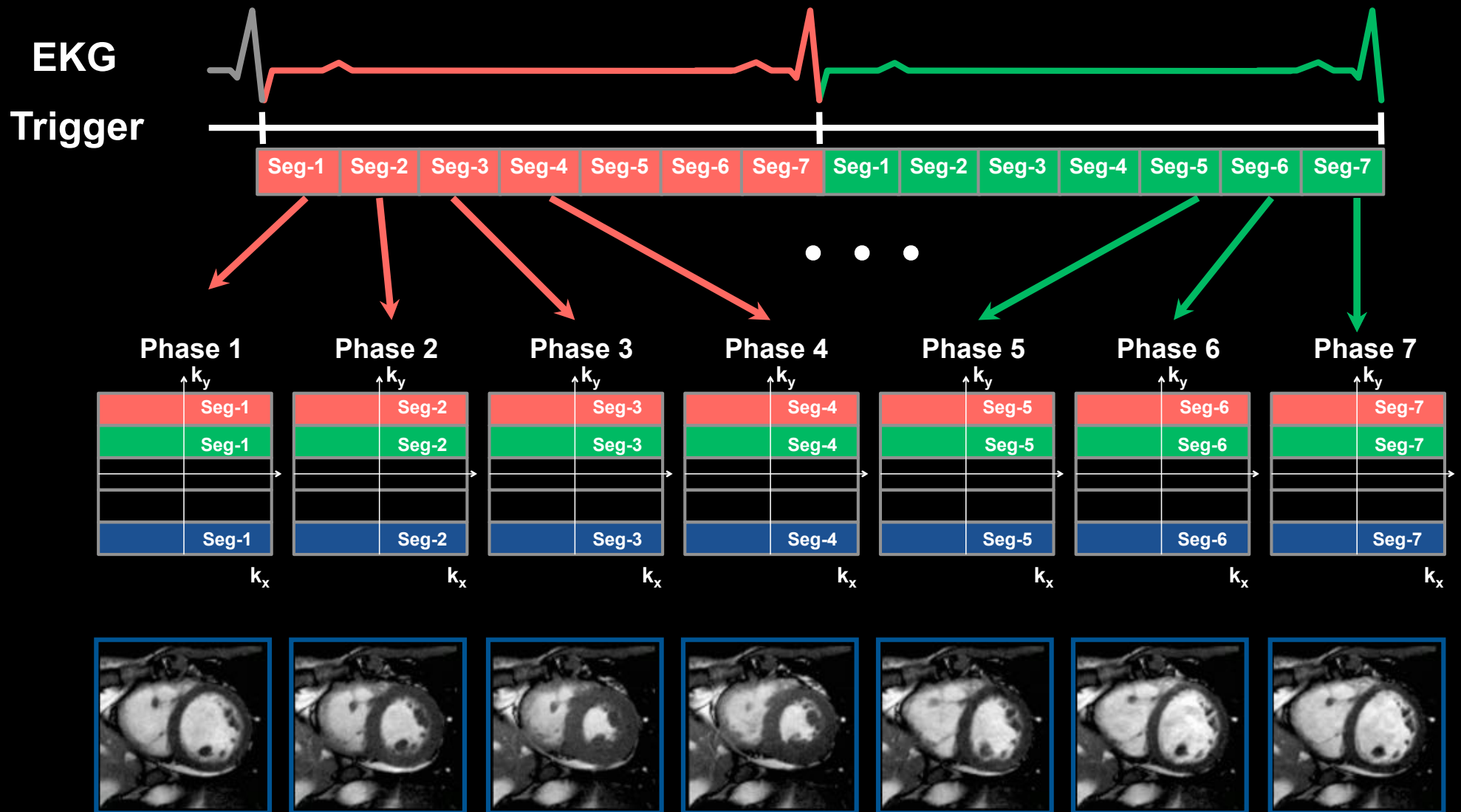

# The Principle of Velocity Encoding

# *k*-space Signal

$$S(\vec{k}) = \int M_{xy}(\vec{r}, 0) e^{-i2\pi\vec{k}\cdot\vec{r}} d\vec{r}$$

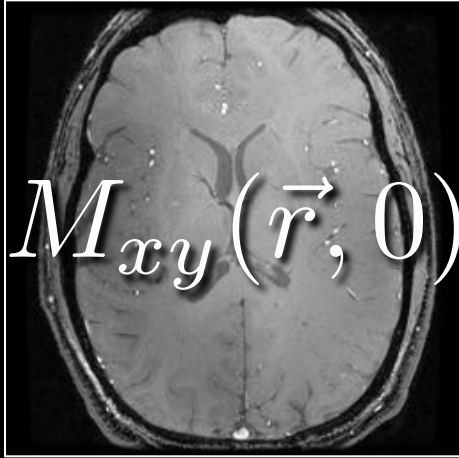
 *object*

 *fourier sample*



$$I(x) = \Delta k \sum_{n=-\infty}^{\infty} S[n] e^{i2\pi n \Delta k x}, \quad |x| < \frac{1}{\Delta k}$$



# Phase from many things...

$\phi_{CS}$	Chemical Shift [1]	Can be minimized.
$\phi_{Sus}$	Susceptibility [2]	Can be corrected.
$\phi_{\delta B_0}$	Inhomogeneity [2]	Can be corrected.
$\phi_{Maxwell}$	Maxwell terms [3]	Can be corrected.
$\phi_{Eddy}$	Eddy currents [4]	Can be minimized.
$\phi_{velocity}$	Applied gradients [5]	Encode velocity!

$$\phi = \phi_{off} + \phi_{velocity}$$

# How do gradients encode velocity?

- Phase arises from a gradient according to:

$$\phi_{\vec{G}}(\vec{r}, t) = \gamma \int \vec{G}(t) \cdot \vec{r}(t) dt$$

- Stronger and longer gradients produce more phase

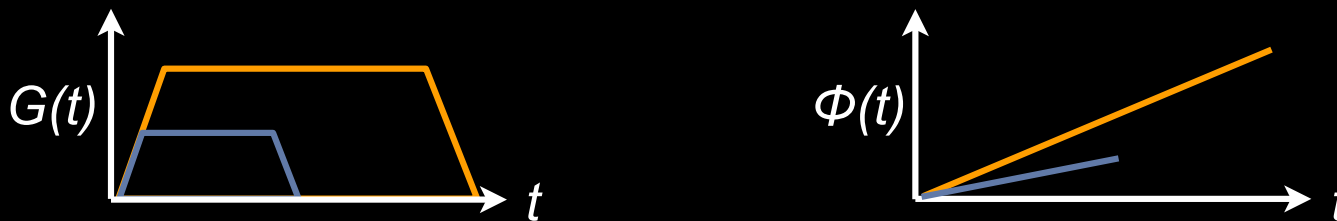

- Spin's position history

$$\vec{r}(t) = \underbrace{\vec{r}_0}_{\text{Initial Position}} + \underbrace{\vec{v}_0 t}_{\text{Initial Velocity}} + \underbrace{\frac{1}{2} \vec{a}_0 t^2}_{\text{Initial Acceleration}} + \dots$$

- Taylor series expansion...

To The Board...



# Chapter 11

## Magnetic Field Gradients

### 11.1 Phase From A Gradient

Gradients can be functions of time as can the position of a spin. The Larmor frequency for a spin in the presence of superposed  $B_0$  and gradient fields in the Laboratory frame is:

$$\omega(t) = \gamma[B_0 + \vec{G}(t) \cdot \vec{r}(t)] \quad (11.1.1)$$

Similarly, in the rotating frame we find:

$$\omega(t) = \gamma\vec{G}(t) \cdot \vec{r}(t) \quad (11.1.2)$$

The phase accorded to the bulk magnetization in the presence of a magnetic field gradient is:

$$\phi_G(\vec{r}, t)|_{t_0}^{t_1} = \int_{t_0}^{t_1} \omega(t) dt = \gamma \int_{t_0}^{t_1} \vec{G}(t) \cdot \vec{r}(t) dt \quad (11.1.3)$$

In general, the position of a spin as a function of time can be written as a Taylor series expansion where we assume orders of motion higher than acceleration are negligible:

$$\vec{r}(t) = \vec{r}_0 + \vec{v}_0 t + \frac{1}{2} \vec{a}_0 t^2 + \dots \quad (11.1.4)$$

When Eqn. 11.1.4 is substituted into Eqn. 11.1.3 it becomes apparent that the phase imparted on the bulk magnetization by a gradient is:

$$\phi_G(\vec{r}, t)|_{t_0}^{t_1} = \gamma \int_{t_0}^{t_1} \vec{G}(t) \cdot (\vec{r}_0 + \vec{v}_0 t + \frac{1}{2} \vec{a}_0 t^2) dt \quad (11.1.5)$$

Therein the dependence on terms of an order higher than acceleration ( $\vec{a}_0$ ) have been dropped and it is apparent that there exists a series of terms of the form  $\vec{G}(t)t^n$ , which accords with the definition of the gradient moments ( $\vec{M}_n$ ):

$$\vec{M}_n = \frac{\gamma}{n!} \int_{t_0}^{t_1} \vec{G}(t) t^n dt \quad (11.1.6)$$

Consequently Eqn. 11.1.5 can be written using Eqn. 11.1.6 as follows:

$$\phi_G(\vec{r}, t)|_{t_0}^{t_1} = \sum_{n=0} \vec{M}_n \frac{d^n \vec{r}}{dt^n} \quad (11.1.7)$$

# No Compensation

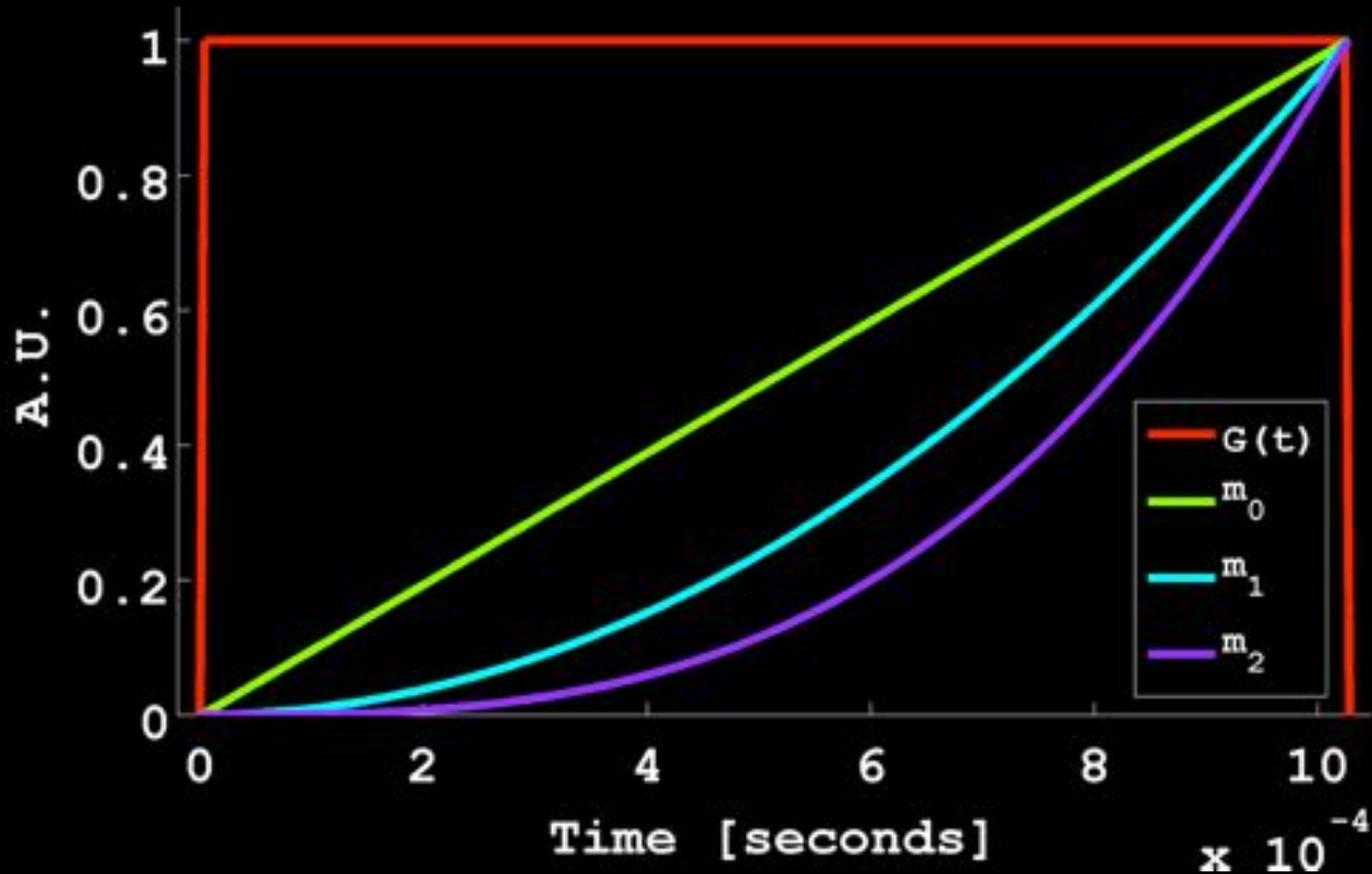

$$\phi_G = \gamma \left[ \vec{M}_0 \cdot \vec{r}_0 + \vec{M}_1 \cdot \vec{v}_0 + \frac{1}{2} \vec{M}_2 \cdot \vec{a}_0 \dots \right]$$

Spin phase ( $\phi_G$ ) accumulates from position, velocity, and acceleration.

# Position Compensation

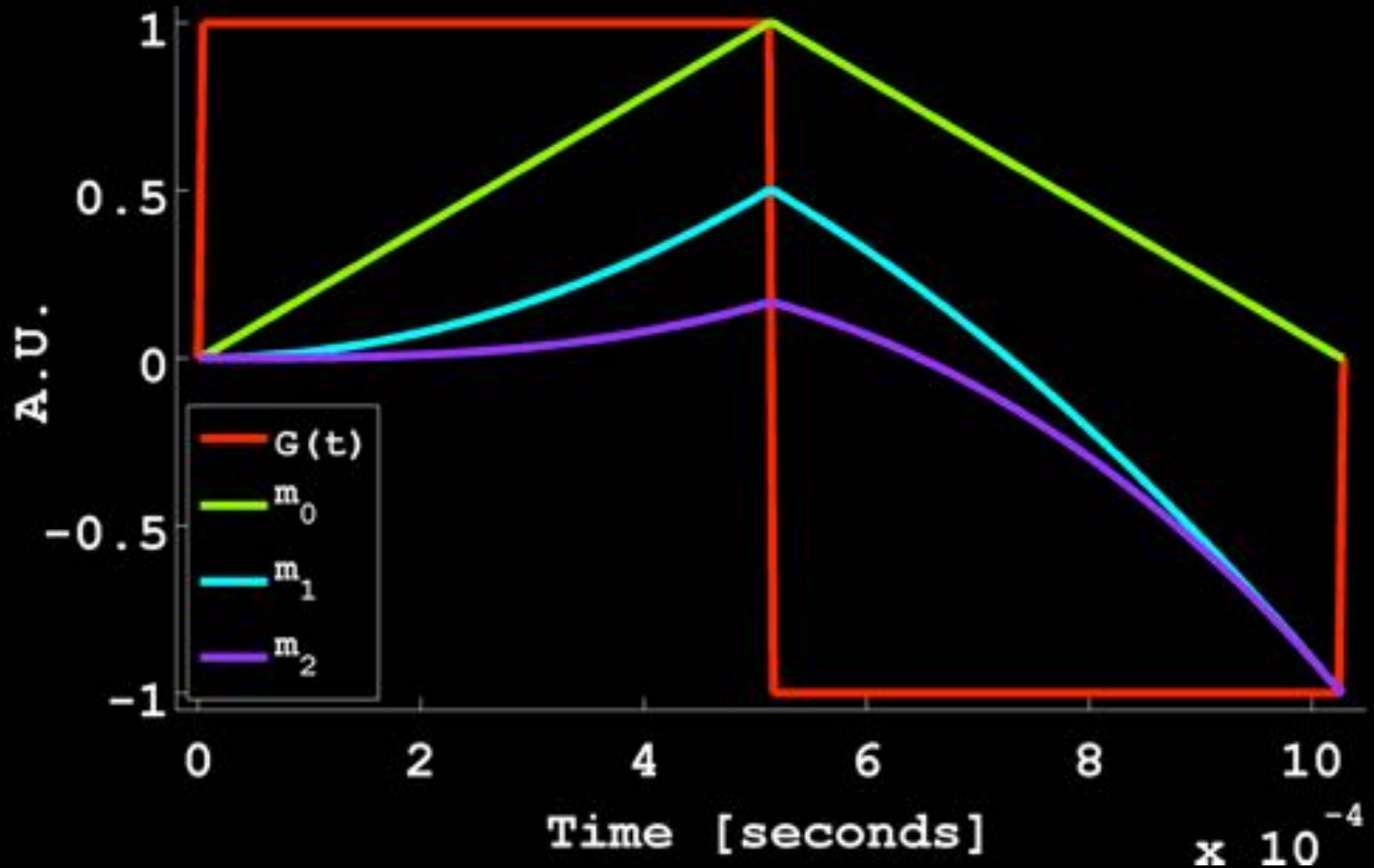

$$\phi_G = \gamma \left[ \vec{M}_1 \cdot \vec{v}_0 + \frac{1}{2} \vec{M}_2 \cdot \vec{a}_0 \dots \right]$$

Spin phase ( $\phi_G$ ) accumulates from velocity and acceleration.

# Velocity Compensation

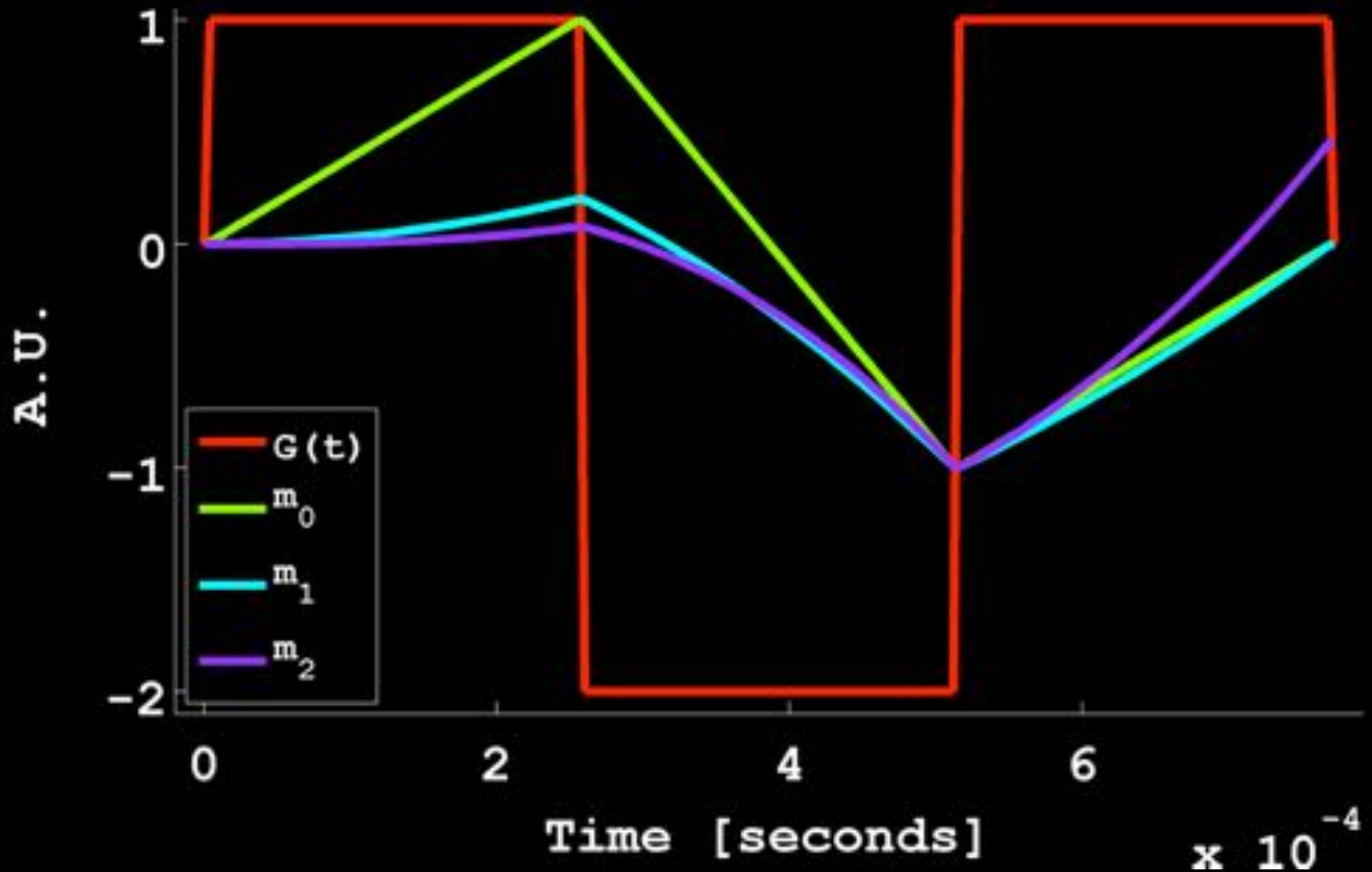

$$\phi_G = \gamma \left[ \frac{1}{2} \vec{M}_2 \cdot \vec{a}_{0\dots} \right]$$

Spin phase ( $\phi_G$ ) accumulates from acceleration.

# How do gradients encode velocity?

- Taken together

$$\phi_G(\vec{r}, t) = \gamma \int \vec{G}(t) \cdot \left[ \vec{r}_0 + \vec{v}_0 t + \frac{1}{2} \vec{a}_0 t^2 \right] dt$$

- For 2D **through-plane** velocity measurements:

$$\phi = \underbrace{\phi_{off}}_{\text{Off-resonance}} + \underbrace{\gamma M_{0,z} \cdot r_{0,z}}_{\text{Position Encoding}} + \underbrace{\gamma M_{1,z} \cdot v_{0,z}}_{\text{Velocity Encoding}}$$

$$M_{0,z} = \int_0^{\tau} G_z(t) dt$$

$$M_{1,z} = \int_0^{\tau} G_z(t) t dt$$

**Design  $M_0$  to be zero.**

**Design  $M_1$  to control  
velocity sensitivity.**

# Flow Encoded

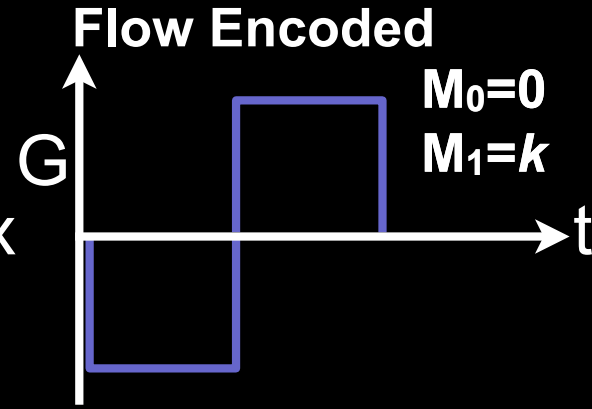
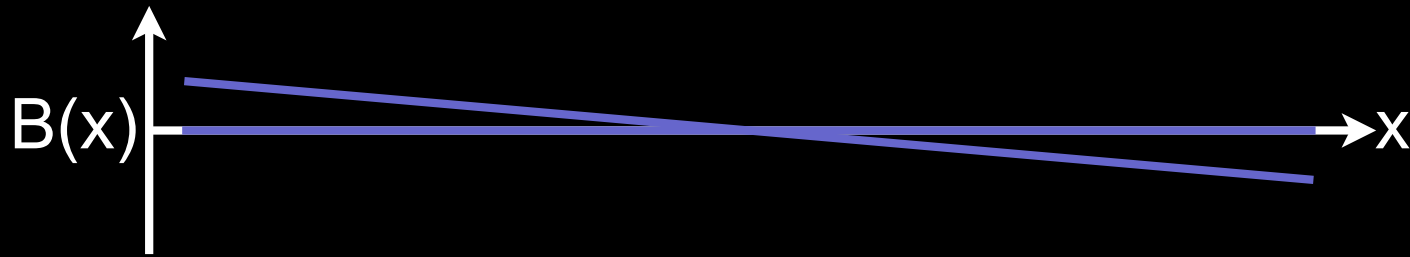

Stationary Tissue

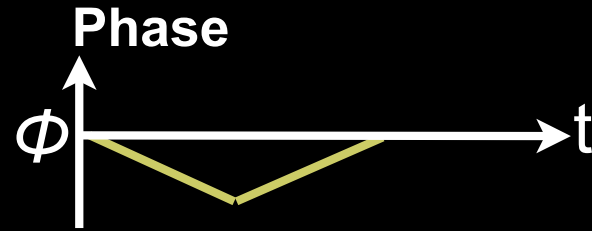
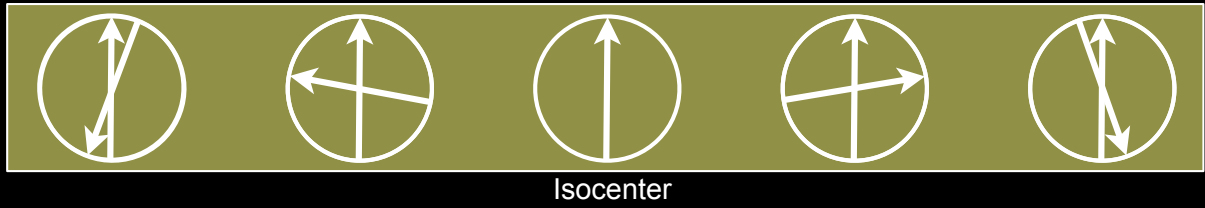

Flowing Blood

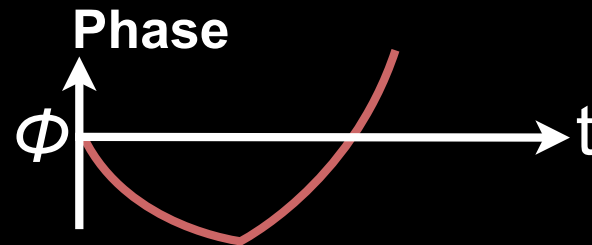
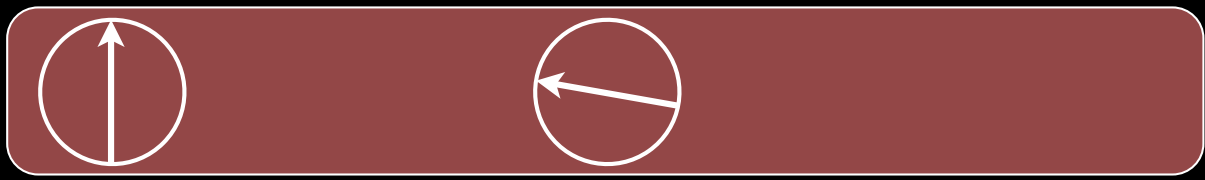

$$\phi_{FE} = \phi_{off} + \gamma \left[ \vec{M}_1 \cdot \vec{v}_0 \right]$$

Spin phase ( $\phi_{FE}$ ) accumulates from off-resonance **and** velocity.

# Theory – Flow Encoding

Magnitude

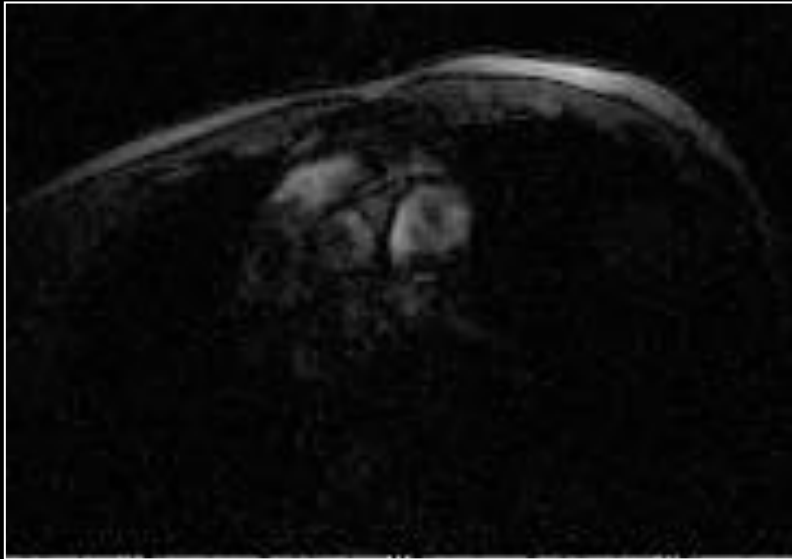

Phase

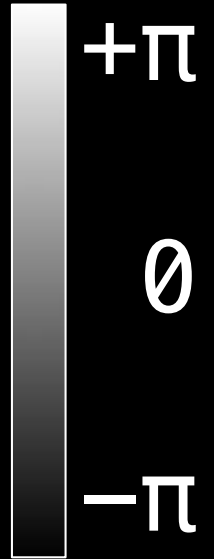

$$\phi_{FE} = \phi_{off} + \gamma M_{1,z} \cdot v_z$$



# Flow Compensation

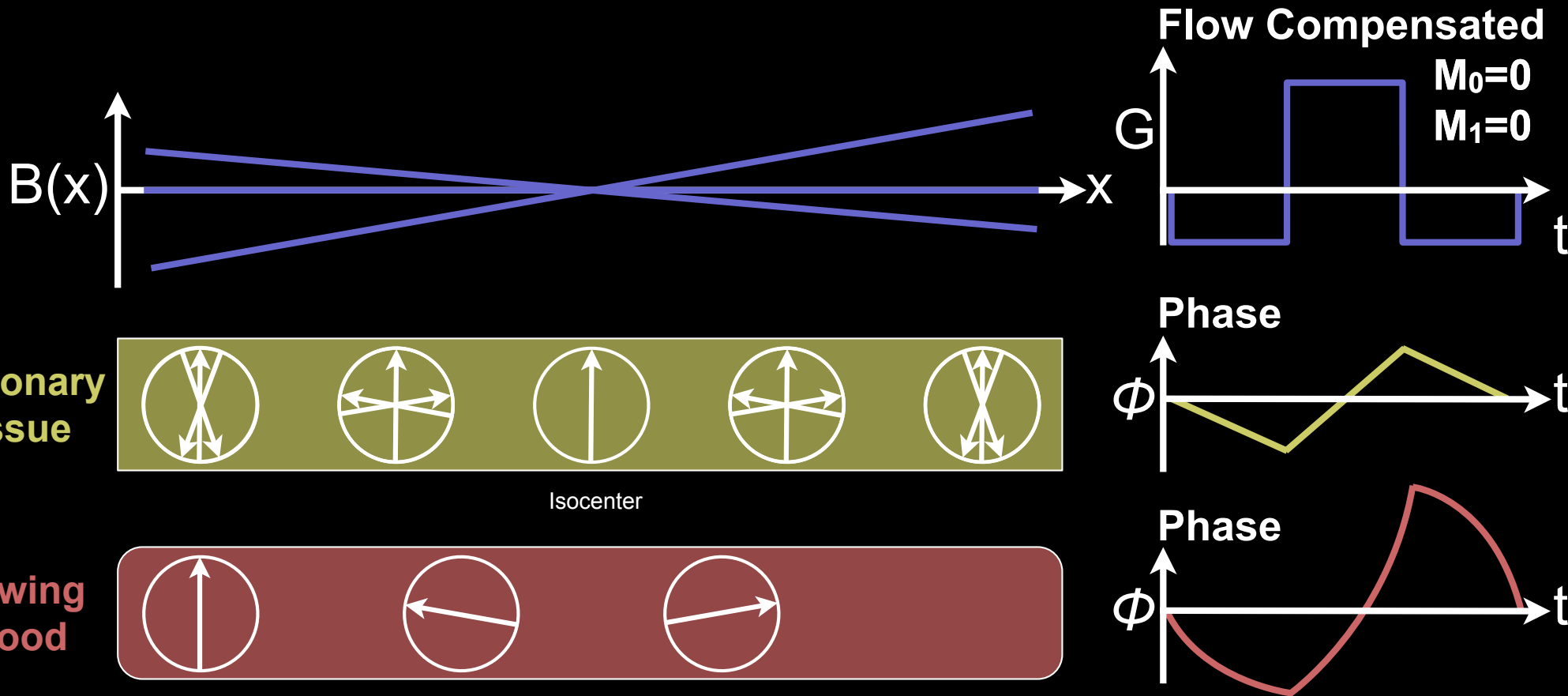

$$\phi_{FC} = \phi_{off}$$

Spin phase ( $\phi_{FC}$ ) **only** accumulates from **off resonance**.

# Theory – Flow Compensation

Magnitude

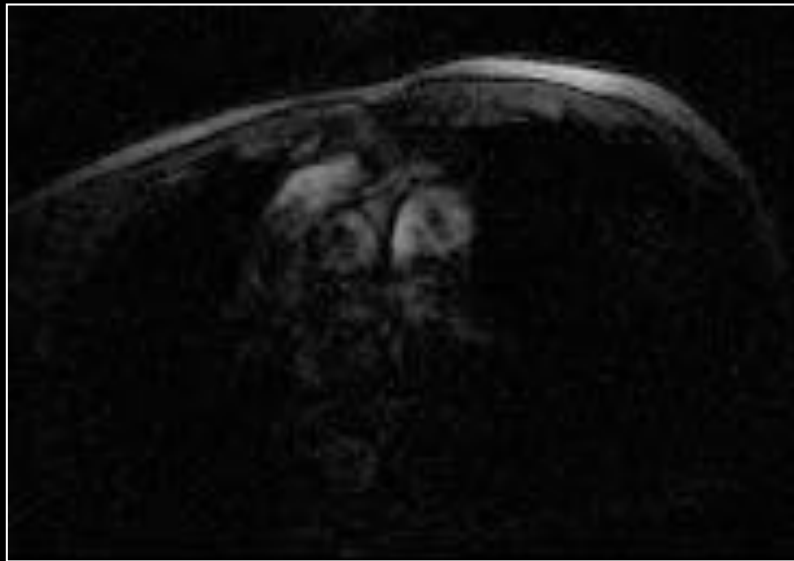

Phase

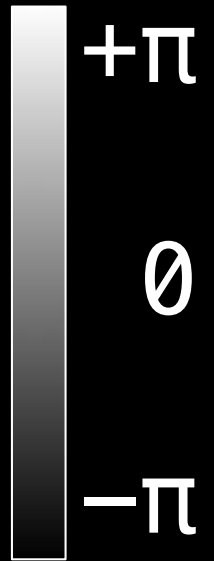
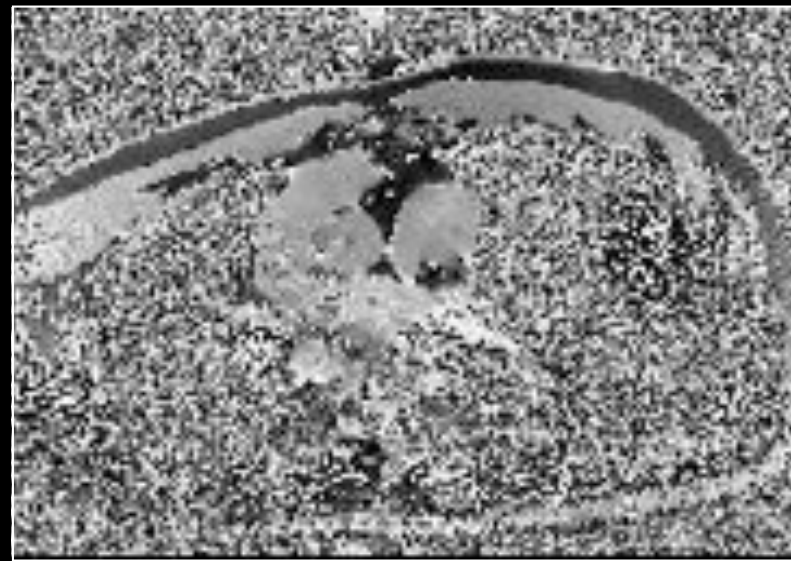

$$\phi_{FC} = \phi_{off}$$

# Theory - Echo Combining

FC

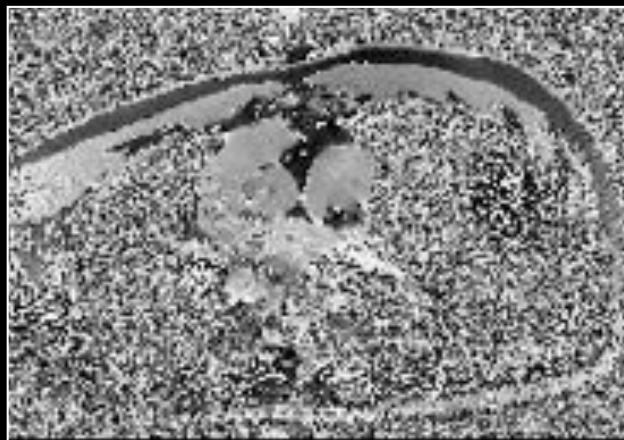

$$\phi_{FC} = \phi_{off}$$

FE

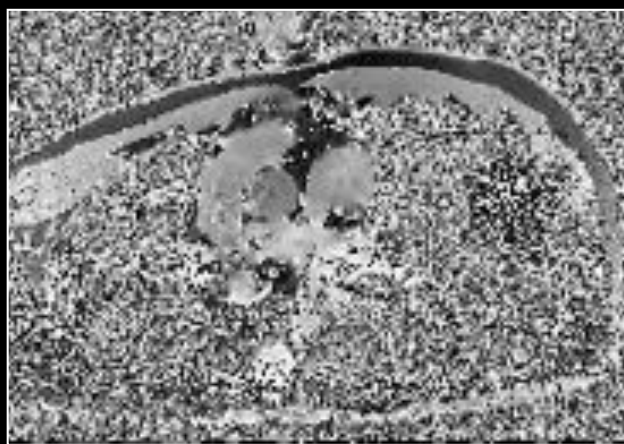

$$\phi_{FE} = \phi_{off} + \gamma M_{1,z} \cdot v_z$$

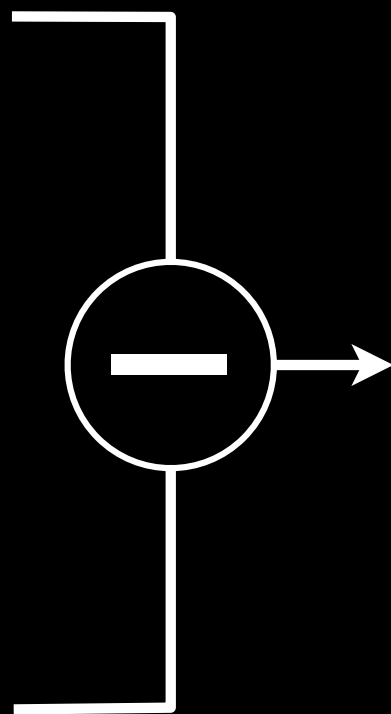

Velocity Map

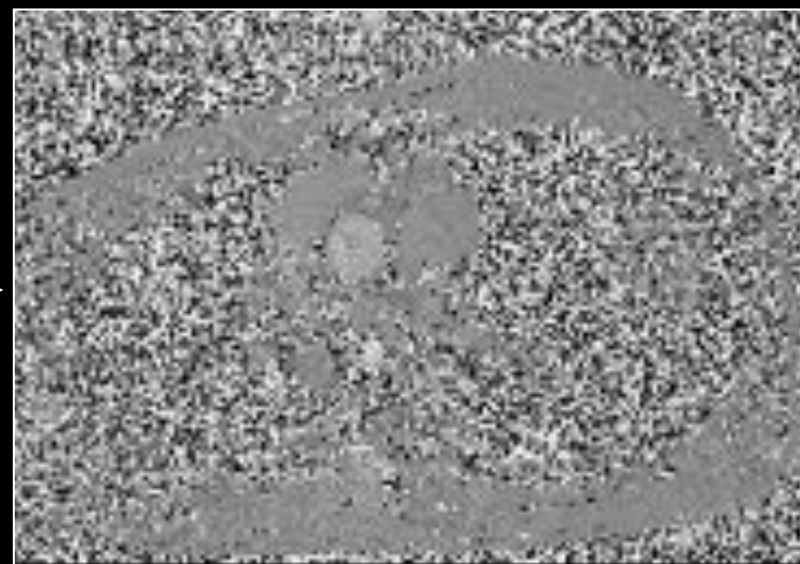

$$\Delta\phi = \gamma v_z \underbrace{\Delta M_{1,z}}$$

Bi-polar Encoding  
Uses Two Non-Zero  $M_{1s}$

# Do we phase difference the data? Not exactly....

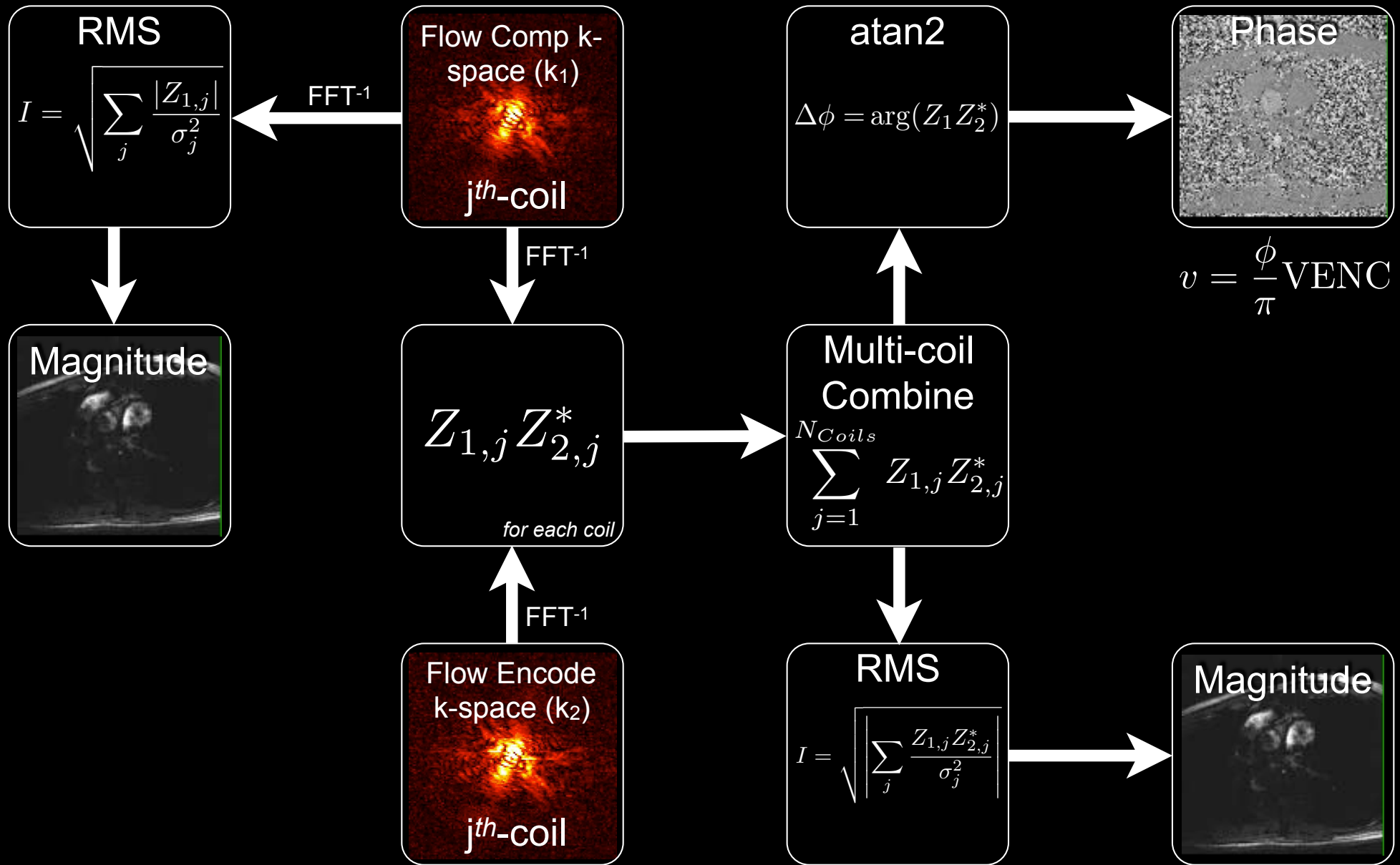

# Velocity Sensitivity

$$\Delta\phi = \gamma v_z \Delta M_{1,z}$$



$$VENC = \frac{\pi}{\gamma |\Delta M_{1,z}|}$$

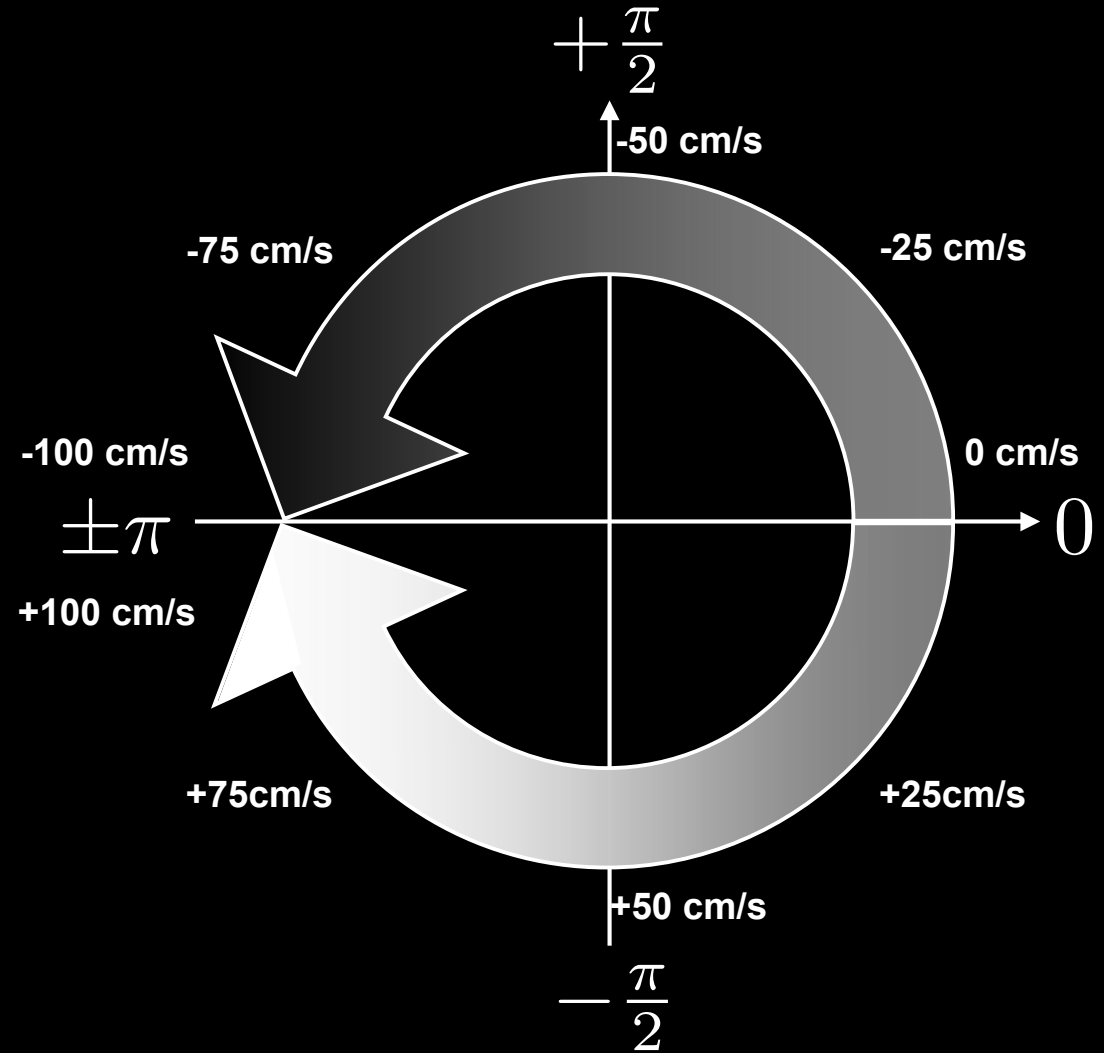

- Phase images can be reconstructed on  $[-\pi, +\pi]$ 
  - **VENC** defines the velocity that produces a phase shift of  $\pm\pi$

# Phase Wrapping

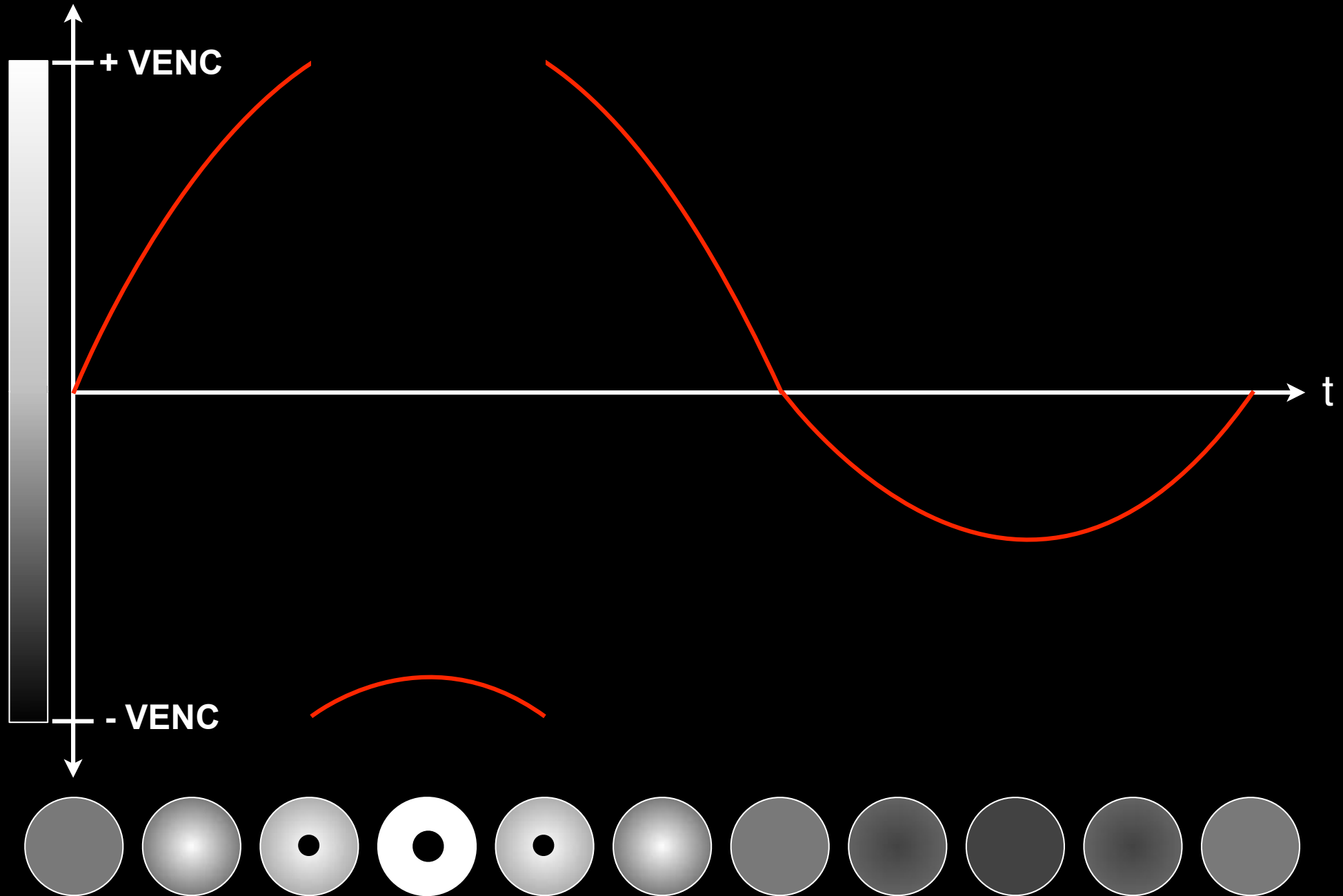

# Phase Un-Wrapping

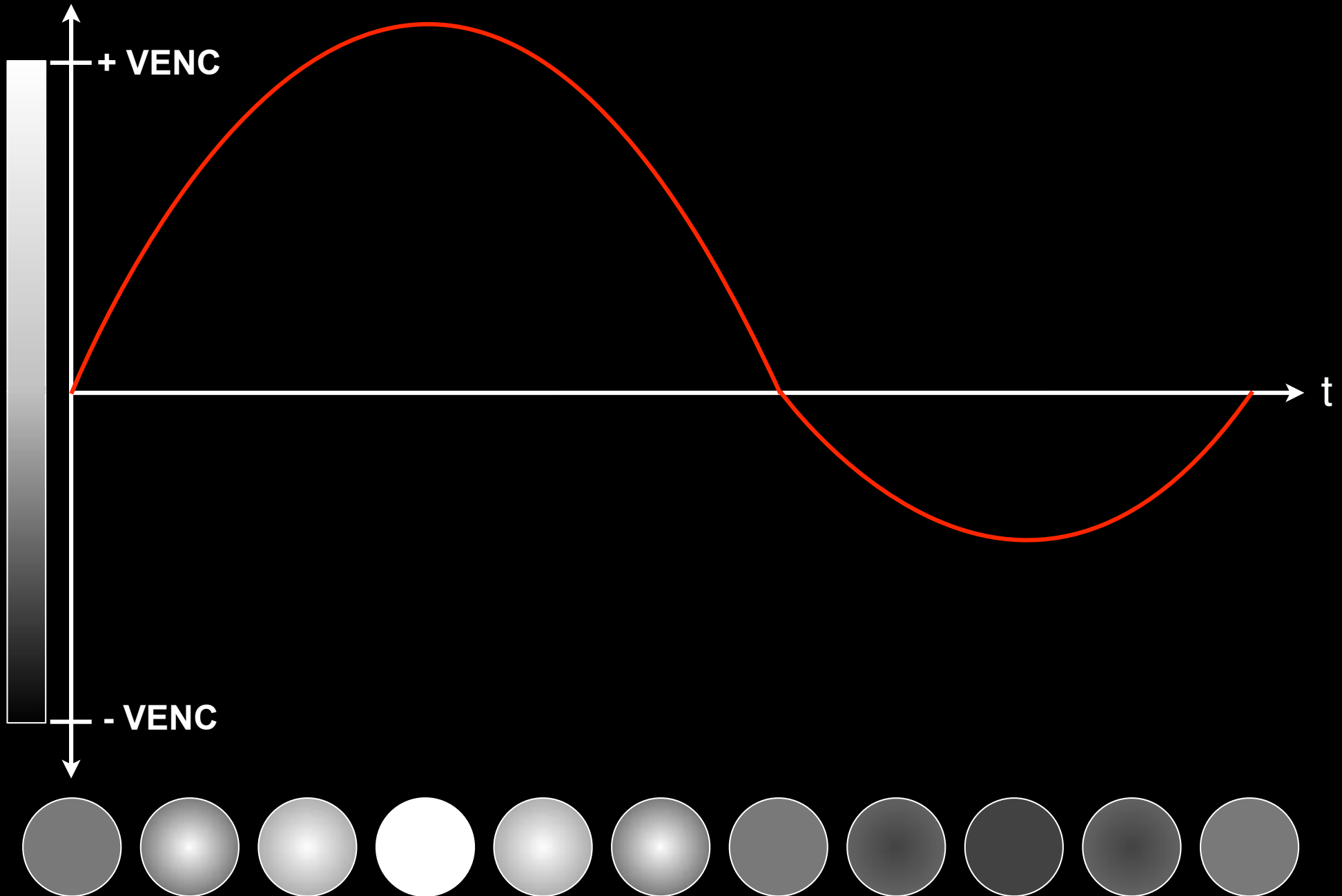

# Phase Contrast

$$\text{VENC} = \frac{\pi}{|\gamma \Delta M_1|}$$

- **VENC typically has units of [cm/s]**
- **HIGH VENC**
  - Low sensitivity
  - Smaller gradient waveform
  - “Unlikely” to phase wrap
- **LOW VENC**
  - High sensitivity
  - Larger gradient waveforms
  - “Likely” to phase wrap



# Phase Wrapping

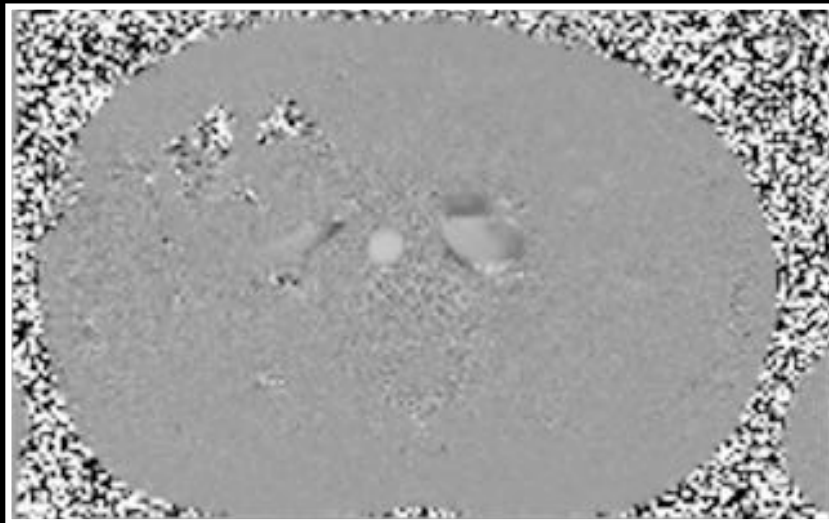
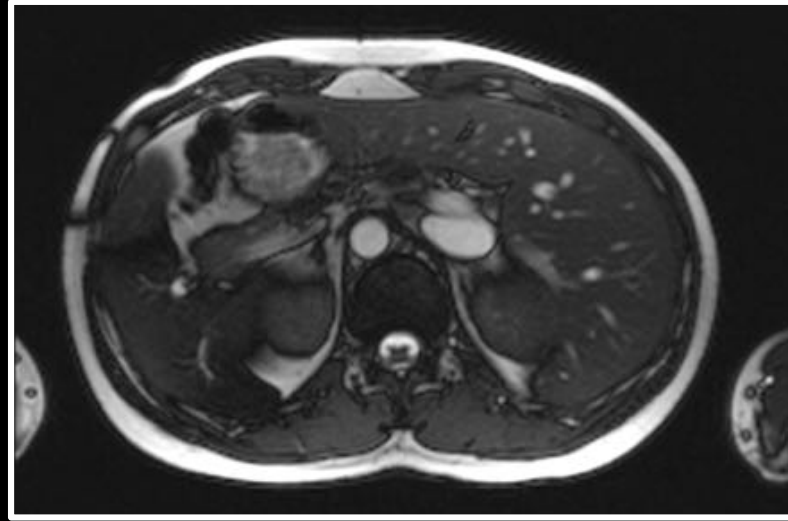

Phase Wrapping - VENC Too Low

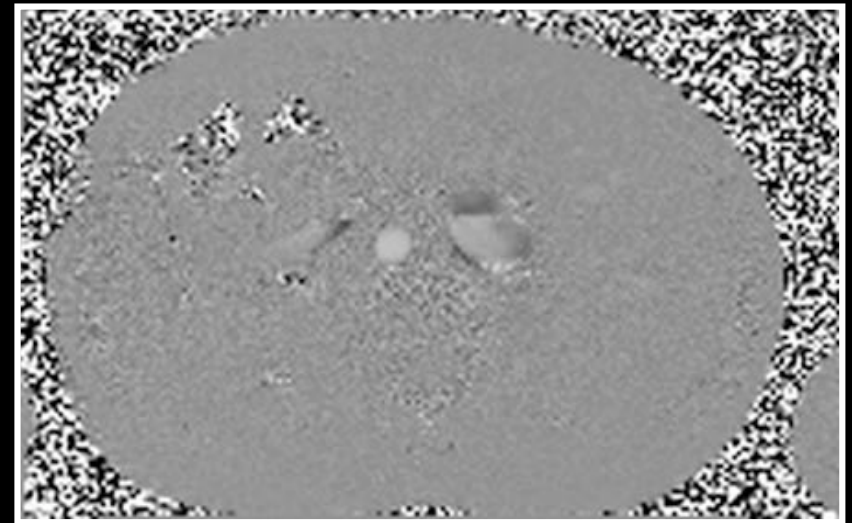

No Phase Wrapping – VENC Just Right

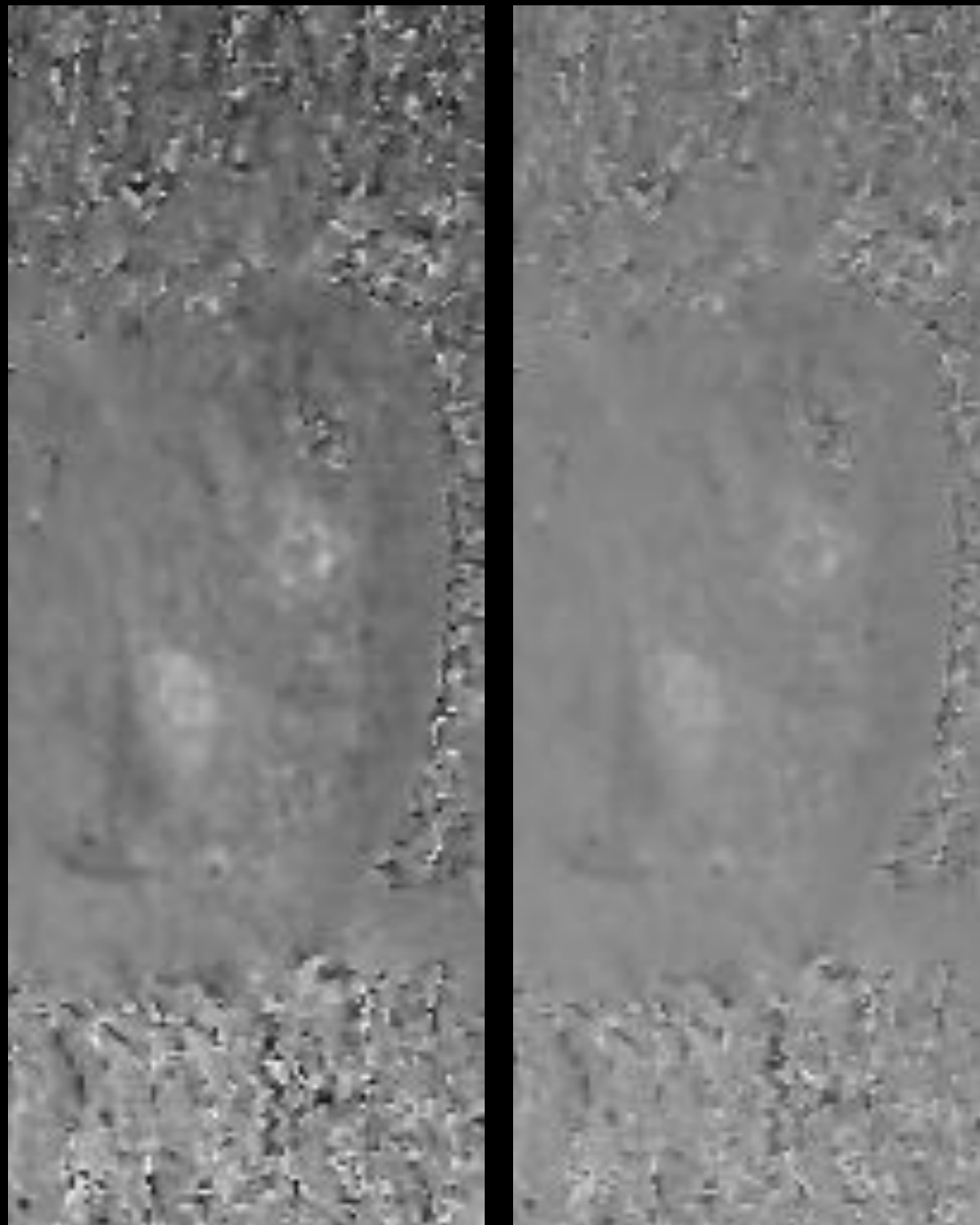

How do we build the sequence?

# Spoiled GRE Sequence

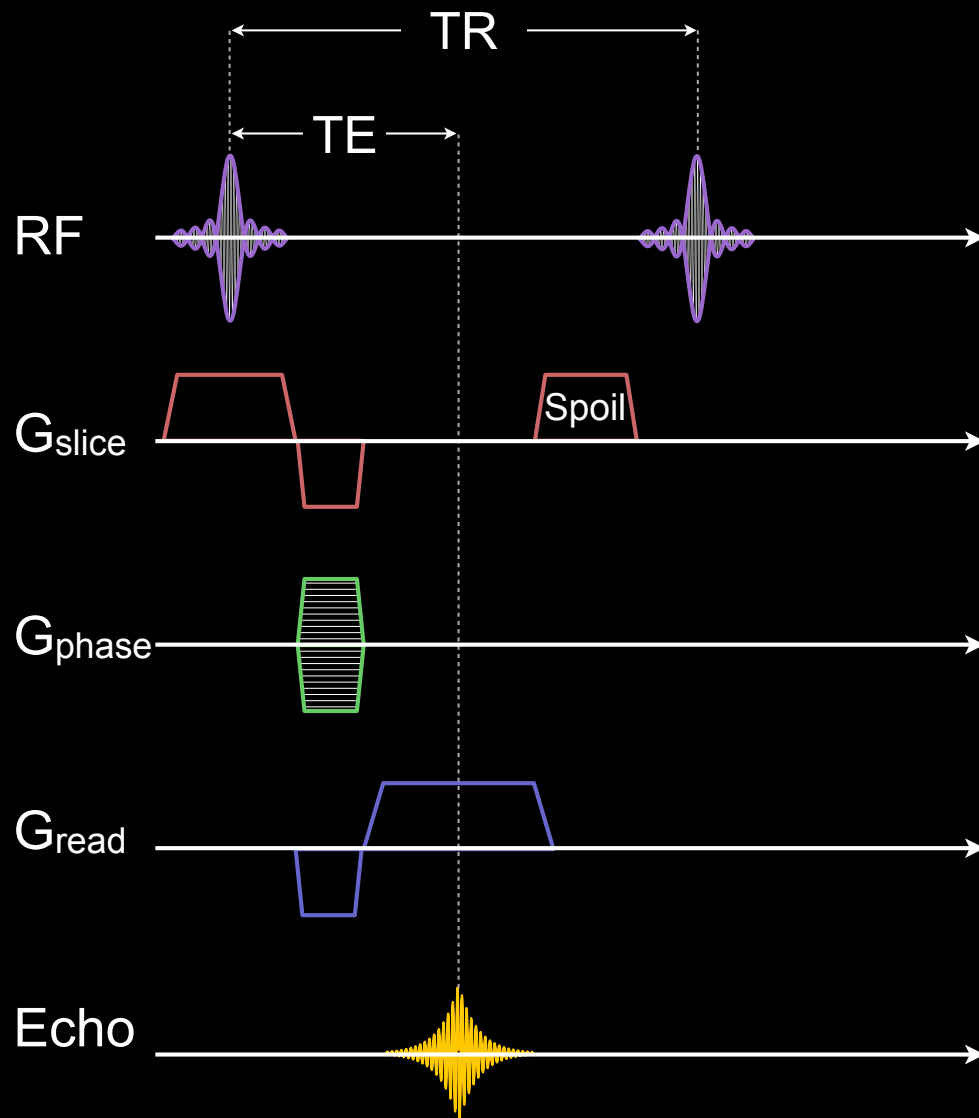

# Flow Compensated Echo

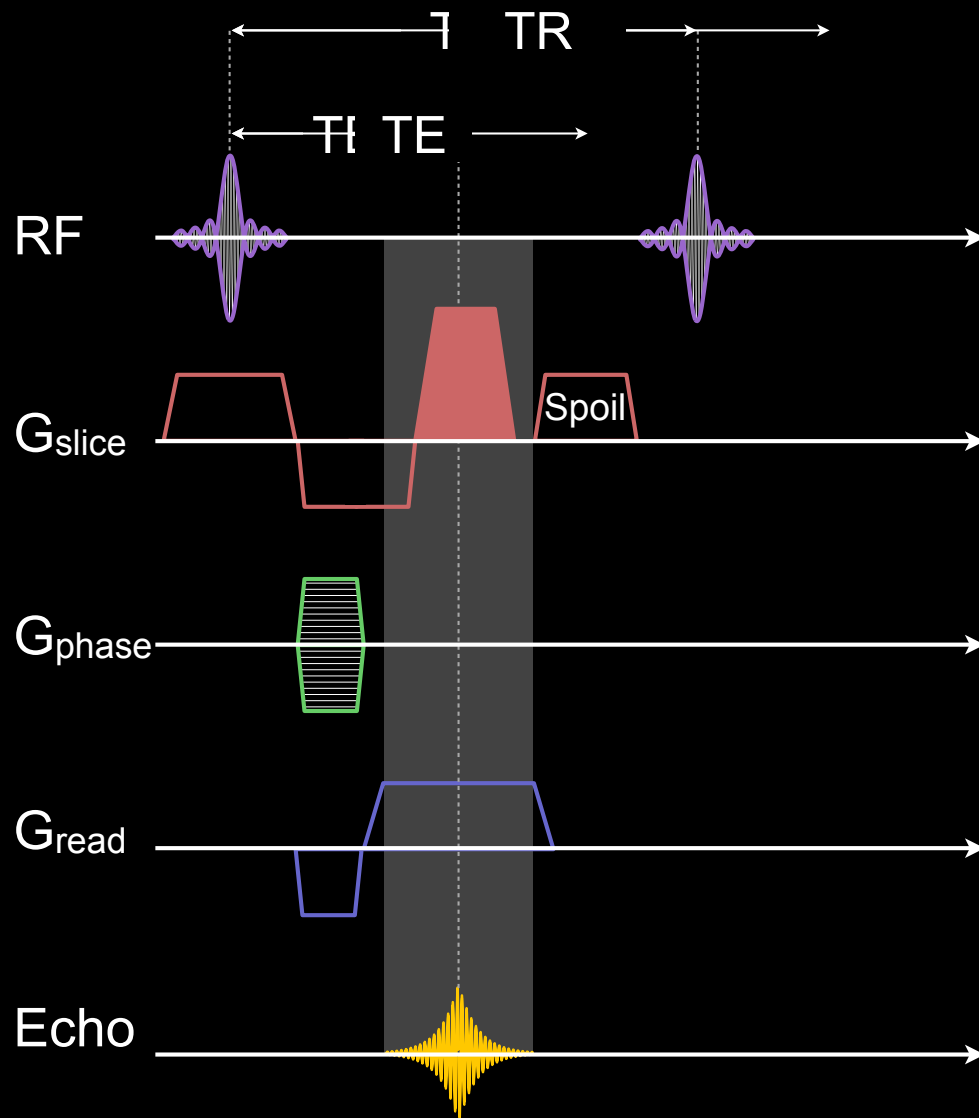

$M_0=0 @ TE$   
 $M_1=0 @ TE$

The TR in PCMRI is 5-15% longer.

# Flow Compensated Echo

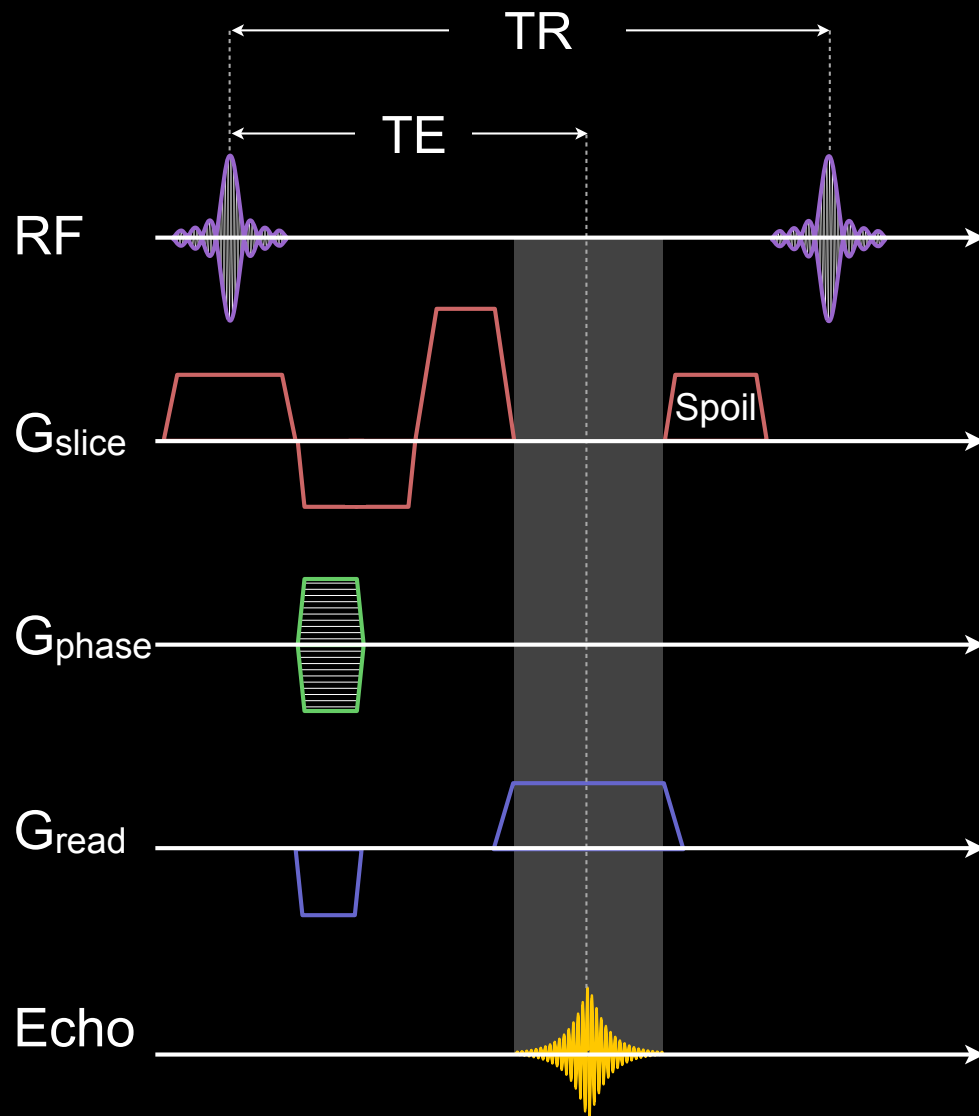

$M_0=0$  @ TE  
 $M_1=0$  @ TE

# Flow Encoded Echo

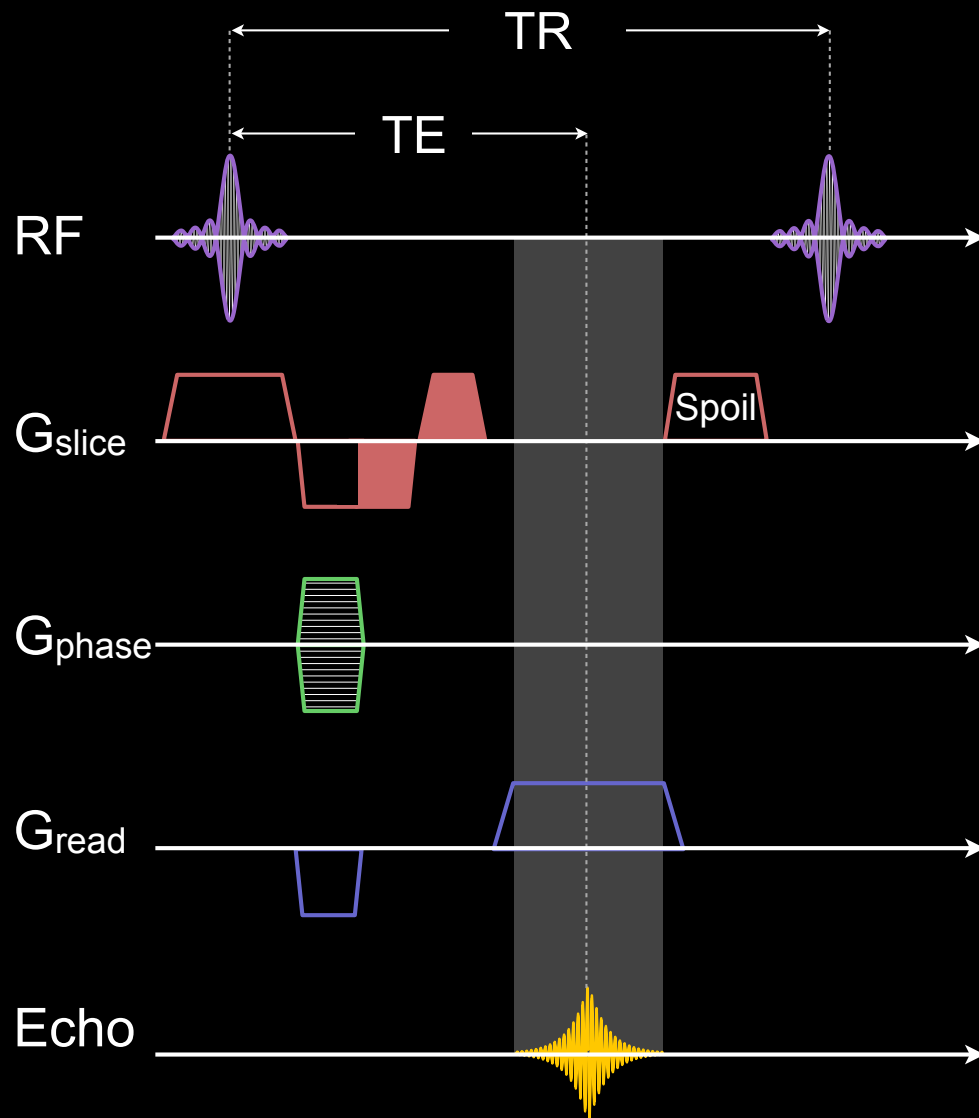

$$M_0 = 0 @ TE$$
$$M_1 \propto 1/VENC @ TE$$

# PC-MRI Sequence

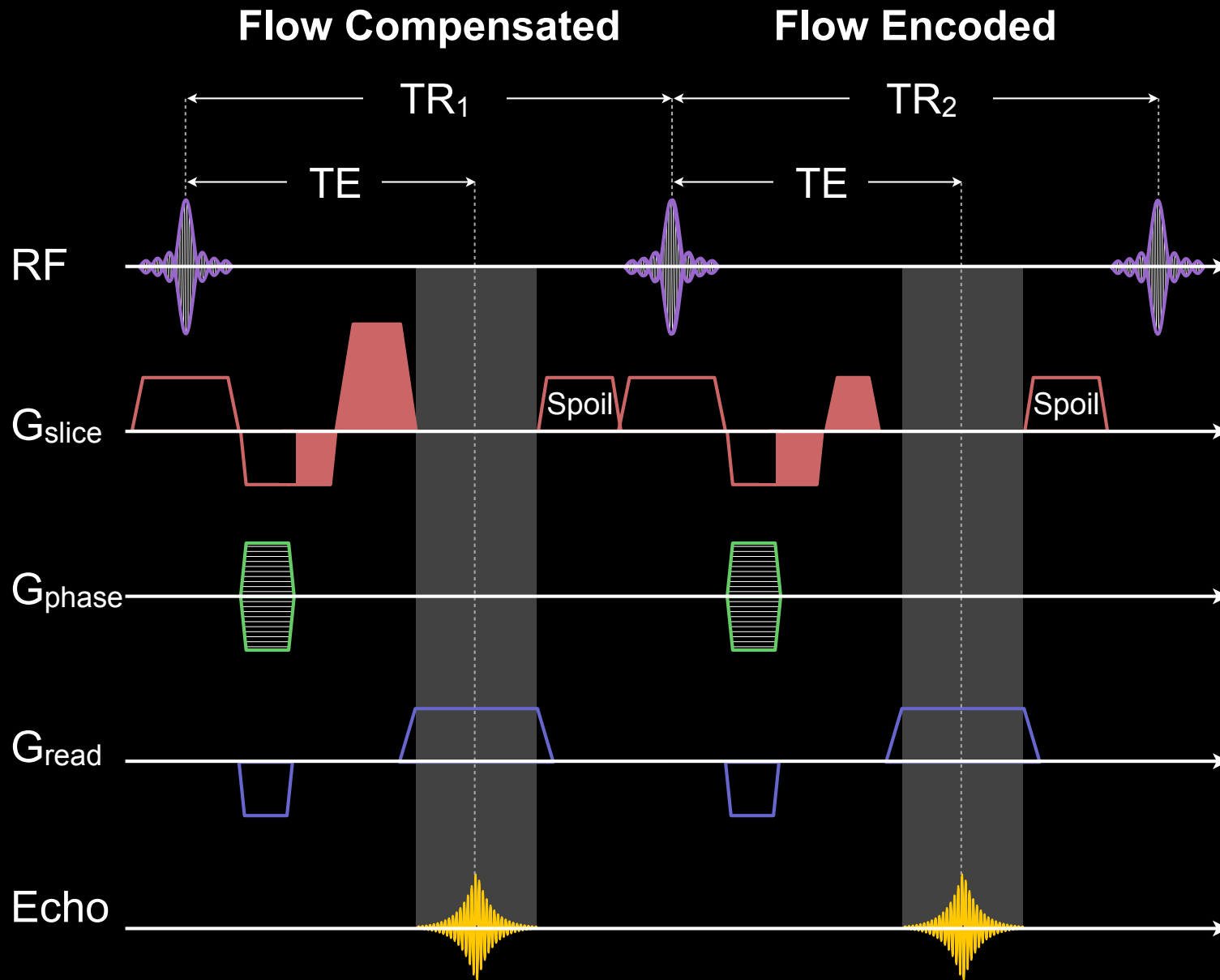

Need to acquire two echoes, therefore temporal resolution decreased.



# PC-MRI Sequence

- **The TE & TR are extended to accommodate:**
  - Flow compensation
  - Flow encoding
- **Two TRs are needed to measure phase**
  - Corrects for background off-resonance
  - Requires twice as much scan time

# Eddy Currents

# Phase from many things...

$\phi_{CS}$	Chemical Shift [1]	Can be minimized.
$\phi_{Sus}$	Susceptibility [2]	Can be corrected.
$\phi_{\delta B_0}$	Inhomogeneity [2]	Can be corrected.
$\phi_{Maxwell}$	Maxwell terms [3]	Can be corrected.
$\phi_{Eddy}$	Eddy currents [4]	Can be minimized.
$\phi_{velocity}$	Applied gradients [5]	Encode velocity!

$$\phi = \phi_{off} + \phi_{velocity}$$

What velocity should I measure  
in a stationary phantom?

# 1.5T Avanto - VENC=100cm/s

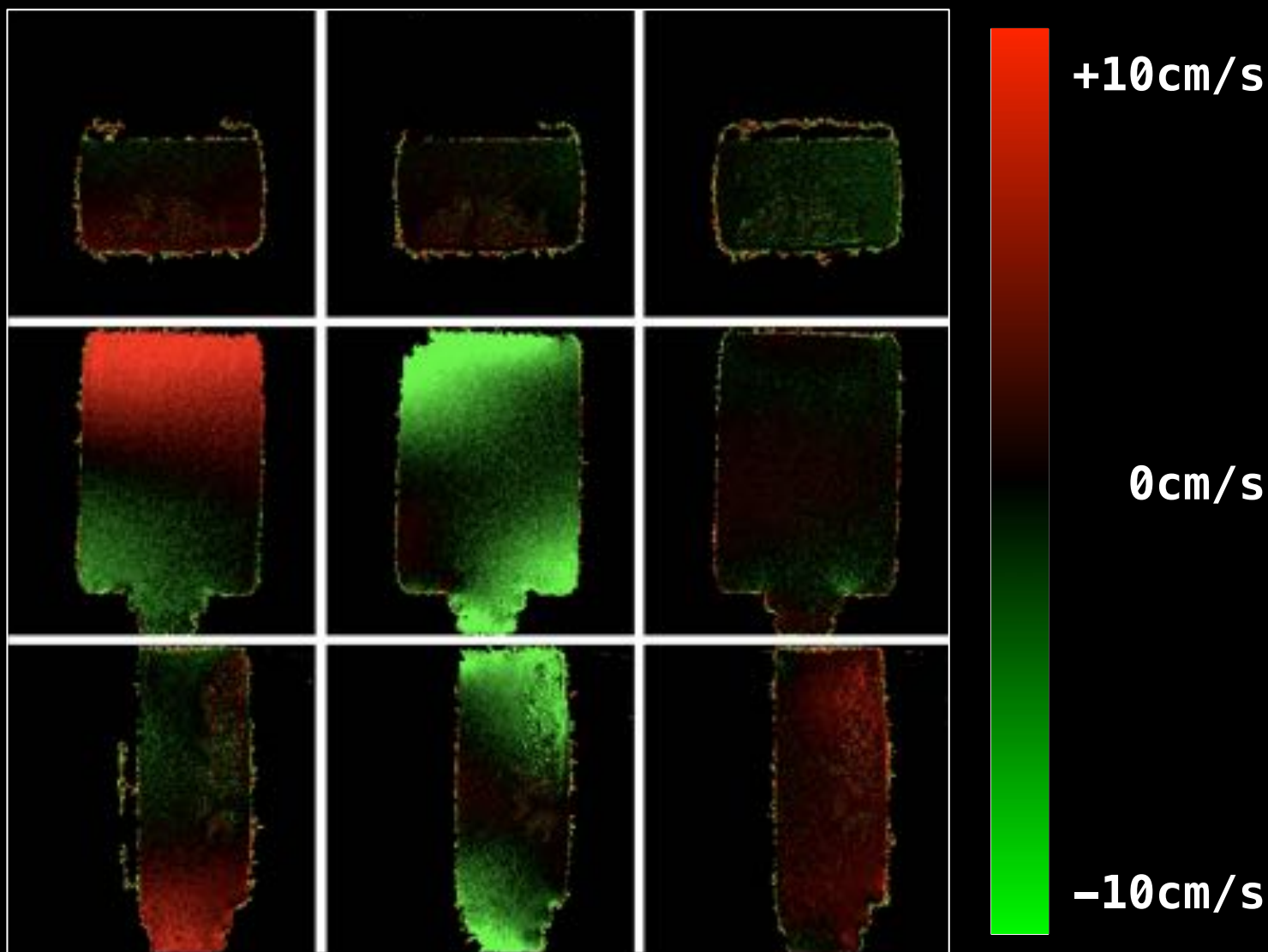

# 1.5T Avanto - VENC=150cm/s

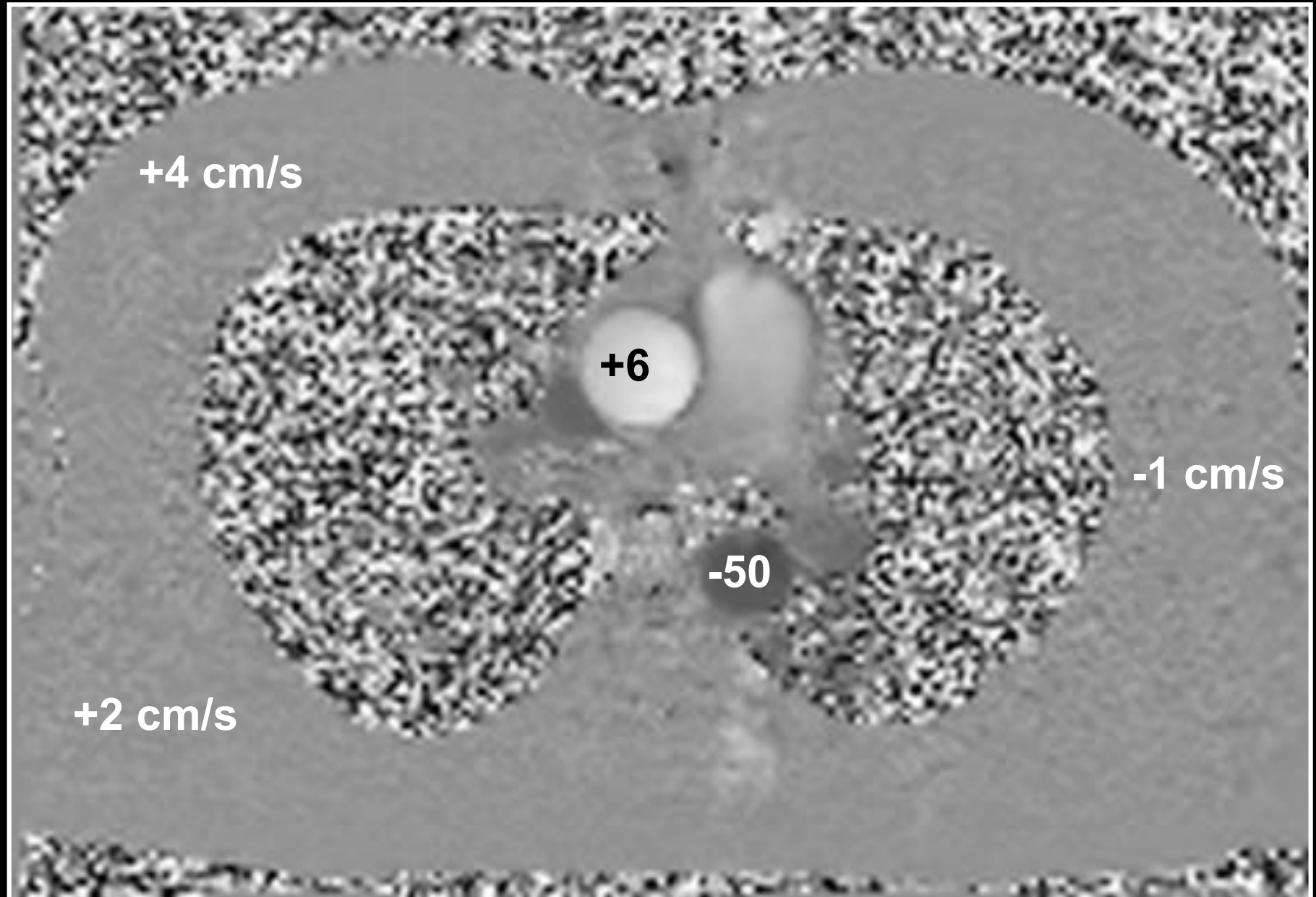

What is the problem?

# Aortic Velocity

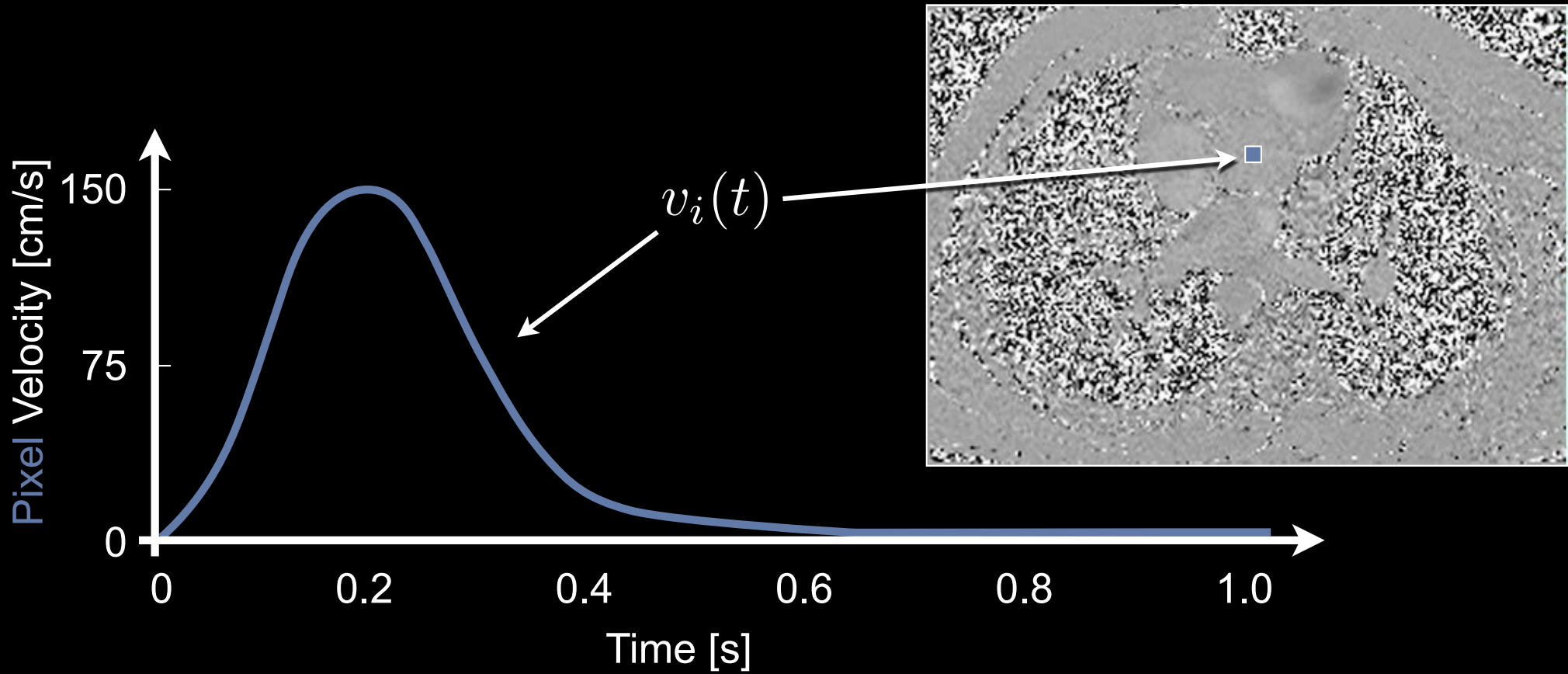



# Aortic Velocity

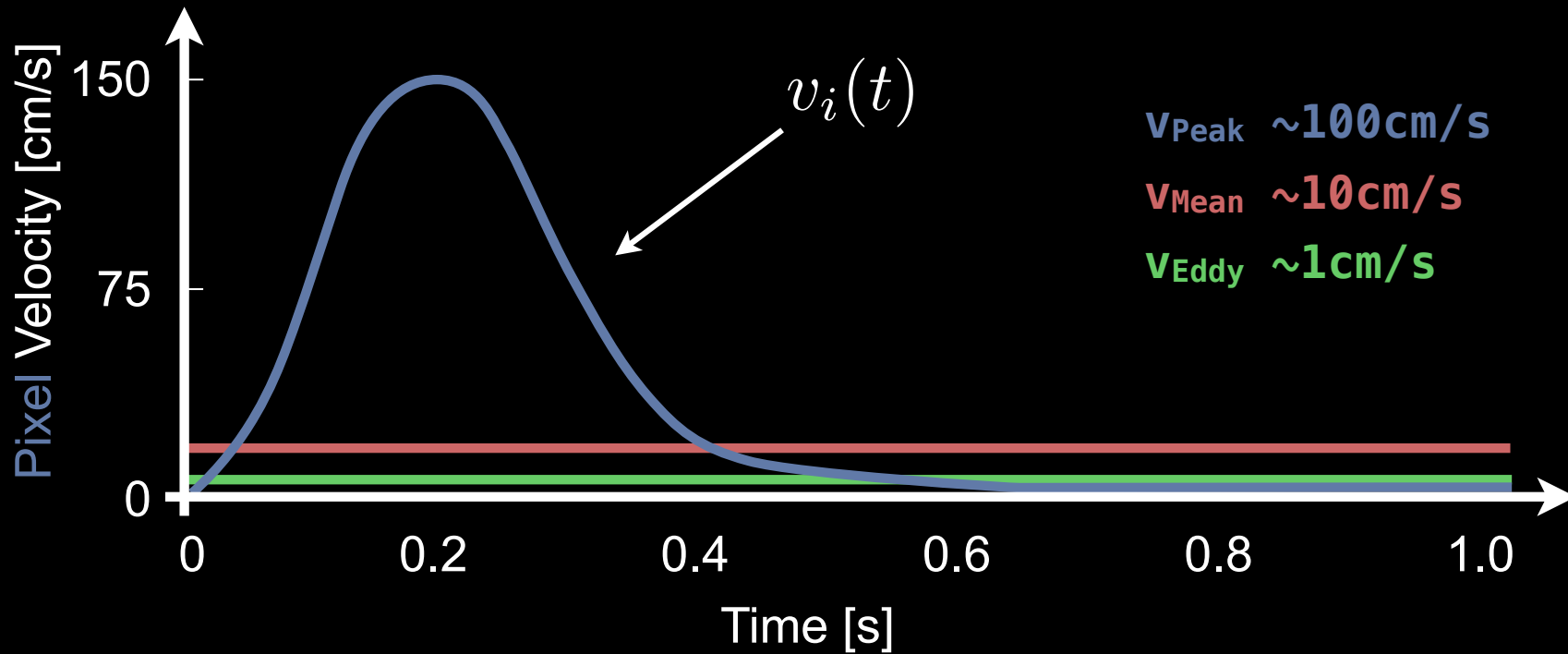

# Aortic Velocity

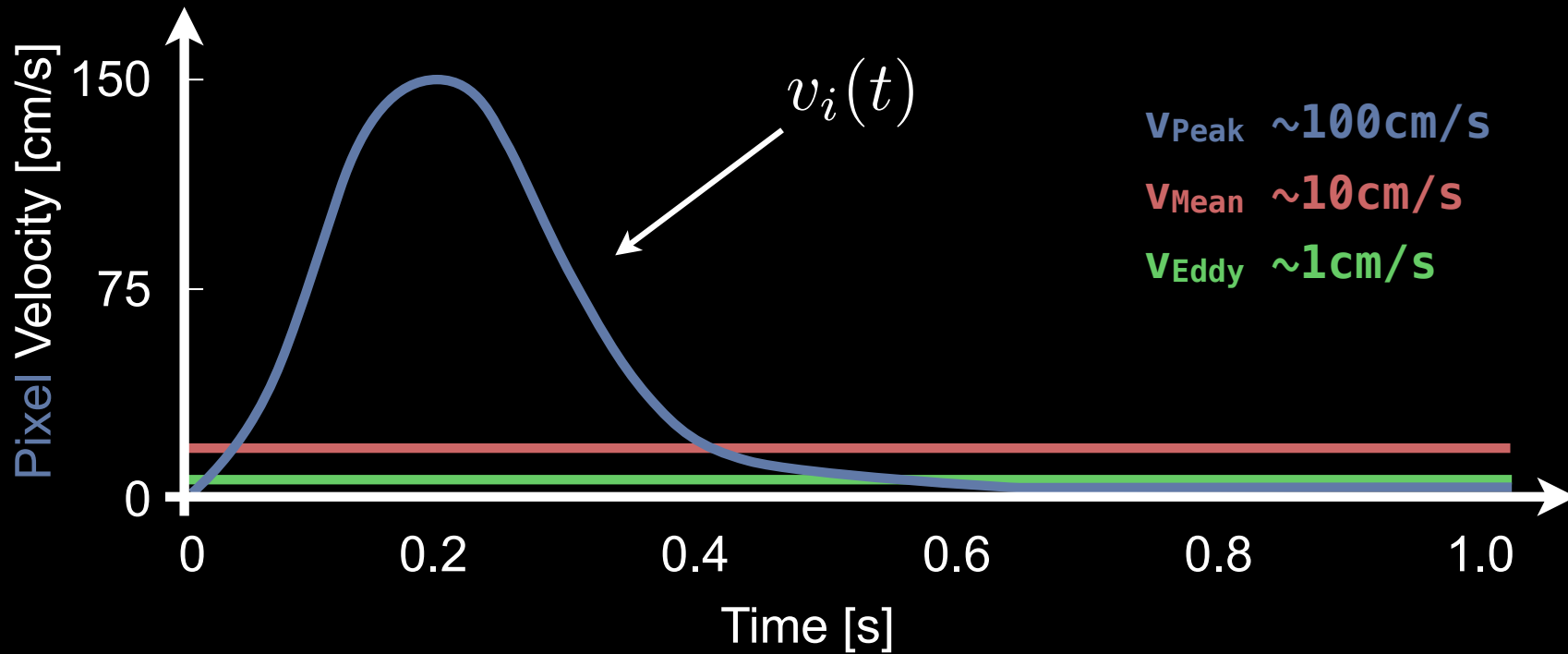

$$Q = \int \left[ \sum_{i=1}^{n_{ROI}} (\vec{v}_i(t) + v_{eddy}) \cdot \vec{A}_i(t) \right] dt \quad \text{Forward Flow [mL]}$$

Adds up over space.

Integrates over time.

# Eddy Current Artifacts: Phase Contrast

$$\begin{aligned}\phi_1 &= \phi_{v_1} + \phi_{off_1} + \phi_{e_1} \\ \phi_2 &= \phi_{v_2} + \phi_{off_2} + \phi_{e_2}\end{aligned}$$

$$\phi_{off_1} = \phi_{off_2} \dots \text{but } \phi_{e_1} = -\phi_{e_2}$$

$$\delta\phi = \phi_{v_1} - \phi_{v_2} + 2\phi_e$$

# Eddy Current Origins: Hardware

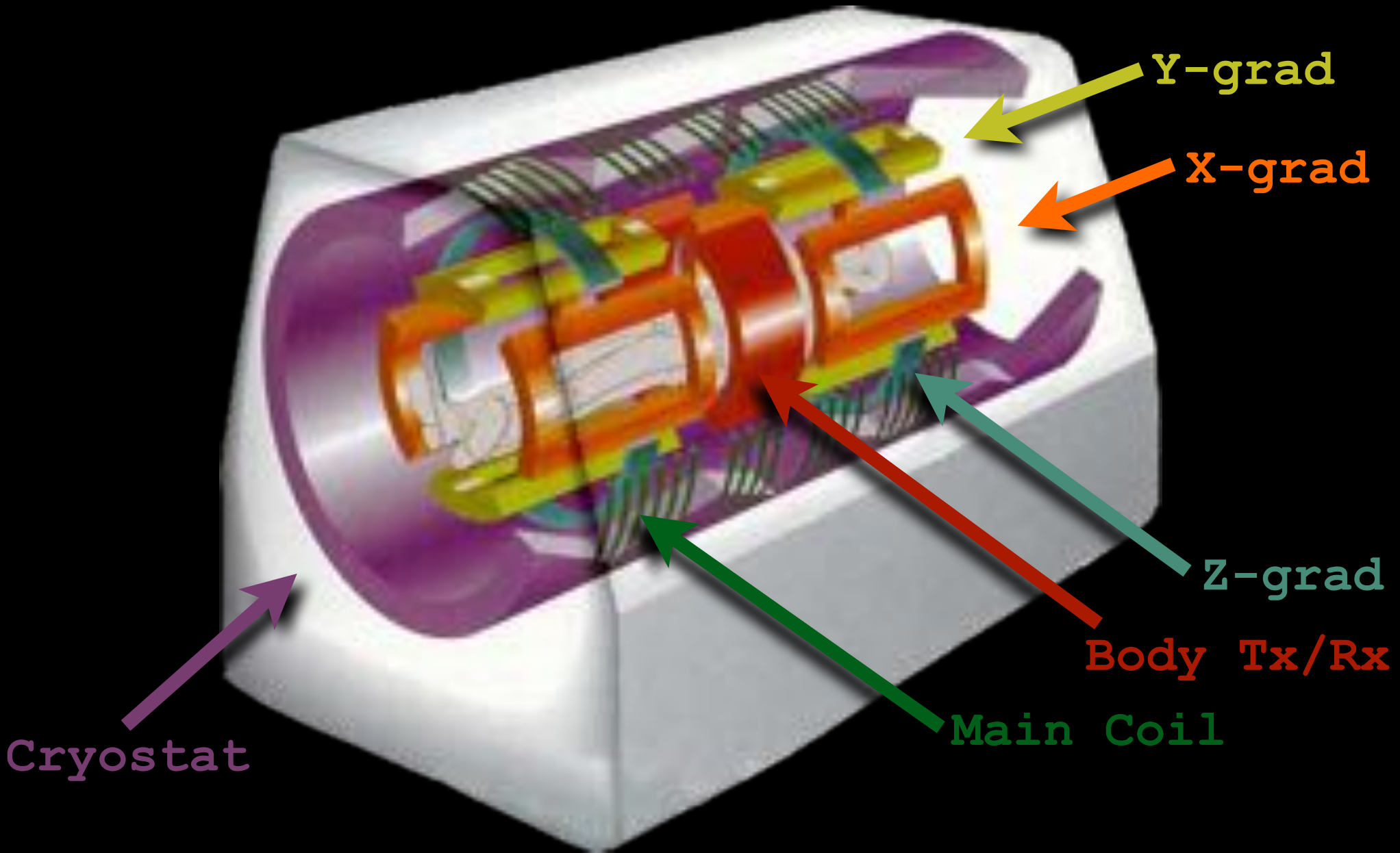

# Eddy Current Origins: Diagram

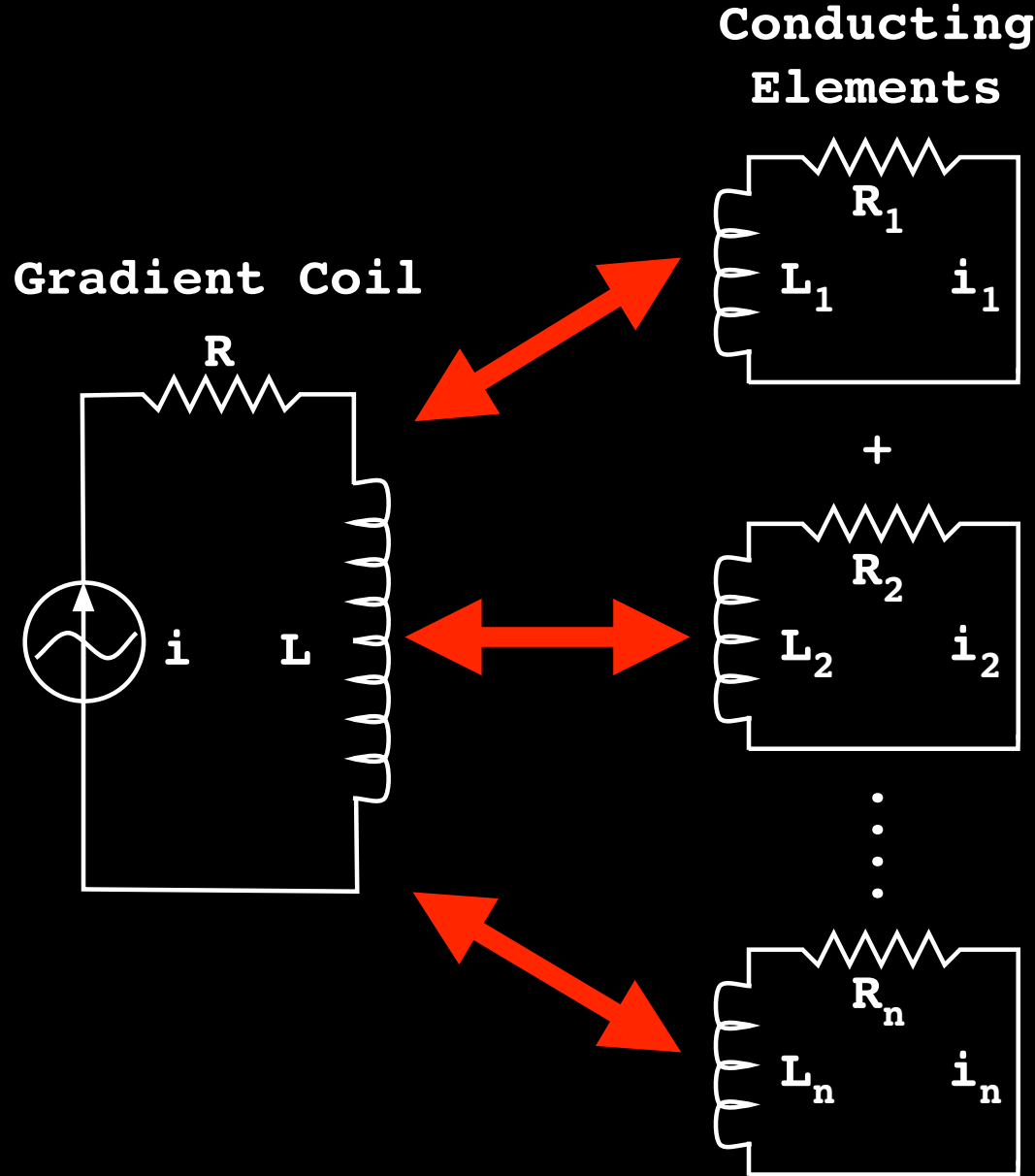

The gradient coil induces currents in nearby structures while *slewing*.

# Eddy Current Gradient Distortion

Ideal Gradient Waveform



Eddy Current Gradients

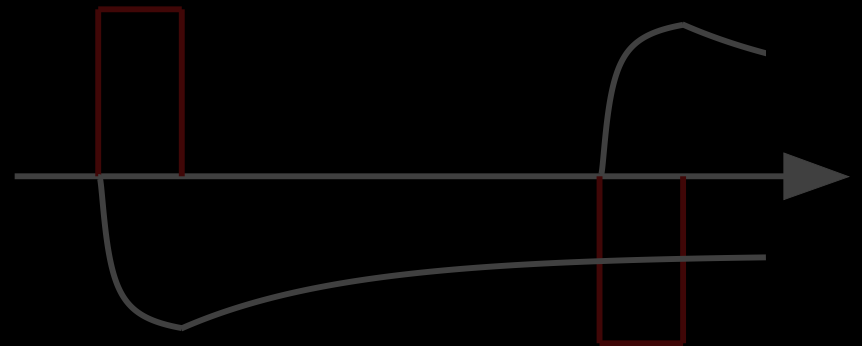

Slewrate Waveform



Actual Gradient Waveform

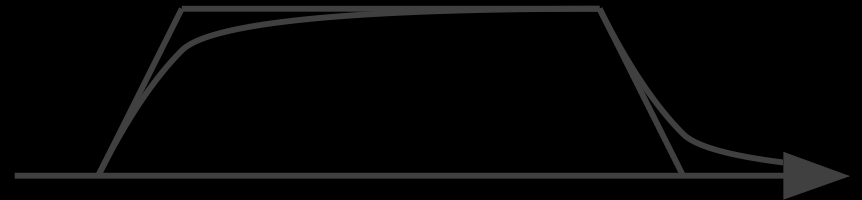

# Eddy Current Origins: Mathematics

$$V_e = - \oint_{\vec{A}} \frac{\partial \vec{G}}{\partial t} \cdot d\vec{A}$$

Faraday's Law

Lenz's Law



$$I_0(t) = I_f \left( 1 - e^{-\frac{Rt}{L}} \right)$$

Ohm's Law

$$I_e(t) = I_0(t_r) e^{-Rt/L}$$

Source-Free  
RL Circuit

$$B_e(t) \propto I_e(t)$$

Eddy Current  
Induced Field

# Eddy Current Compensation

- **Hardware**
  - **Shielded Gradient Coils**
  - **Waveform Pre-emphasis**
- **Pulse Sequence**
  - **Slewrate de-rating**
  - **Twice Re-focused Spin Echo**
- **Reconstruction**
  - **Measure & Subtract (PC)**
  - **Predict & Subtract**



# 4D Flow

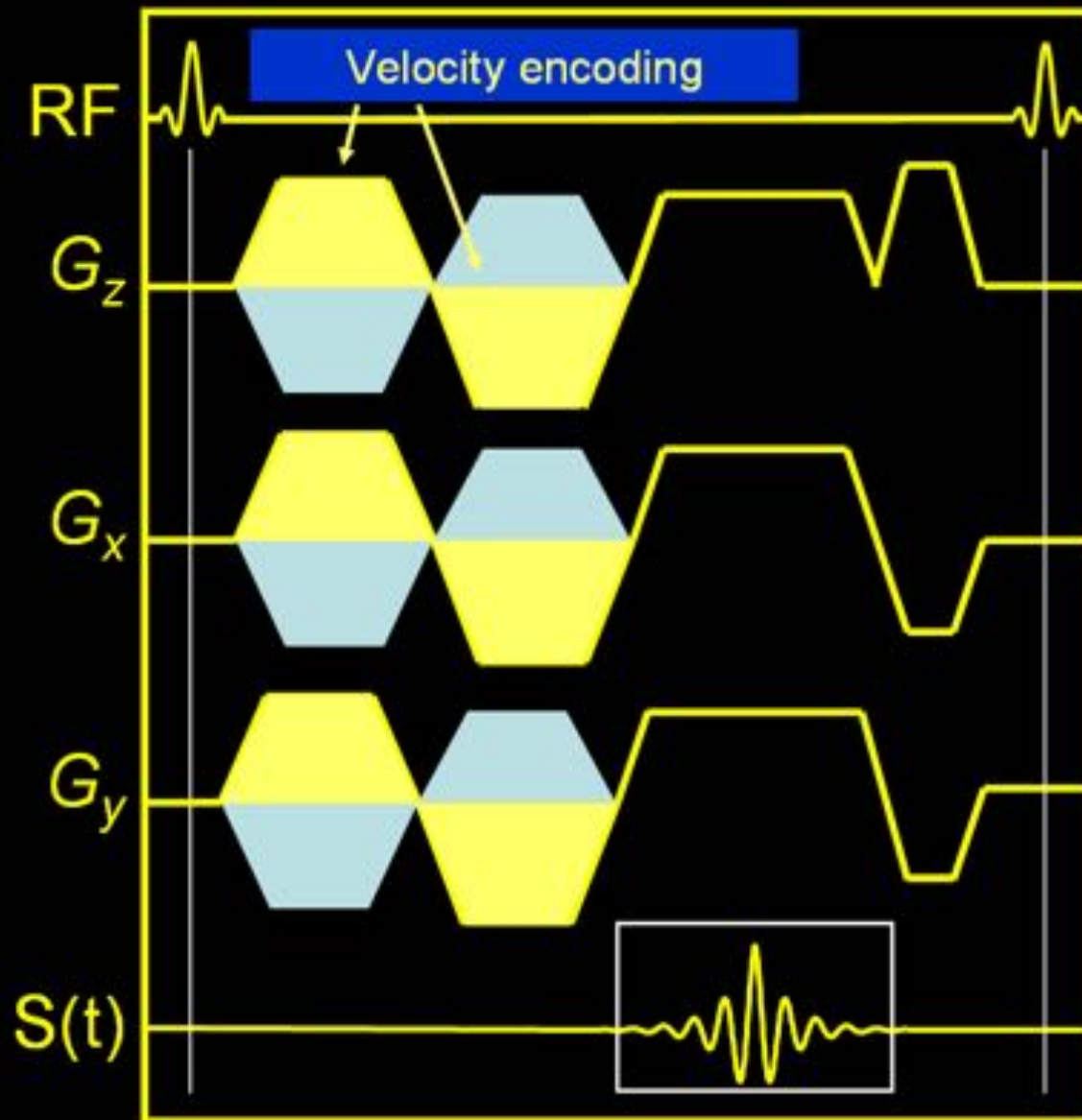

3 Directional encoding  
 - 4 separate velocity encodes

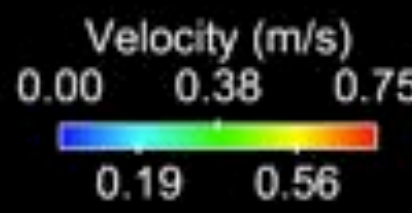
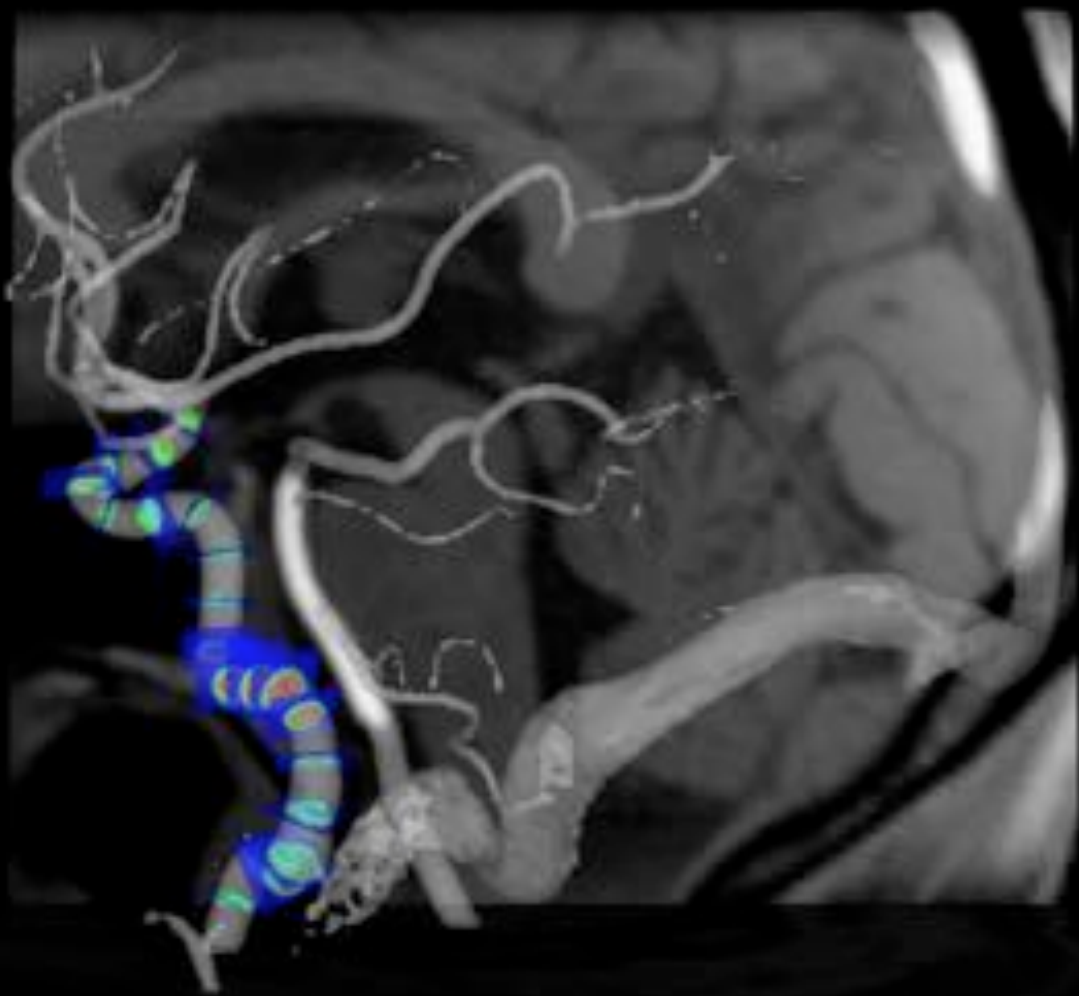

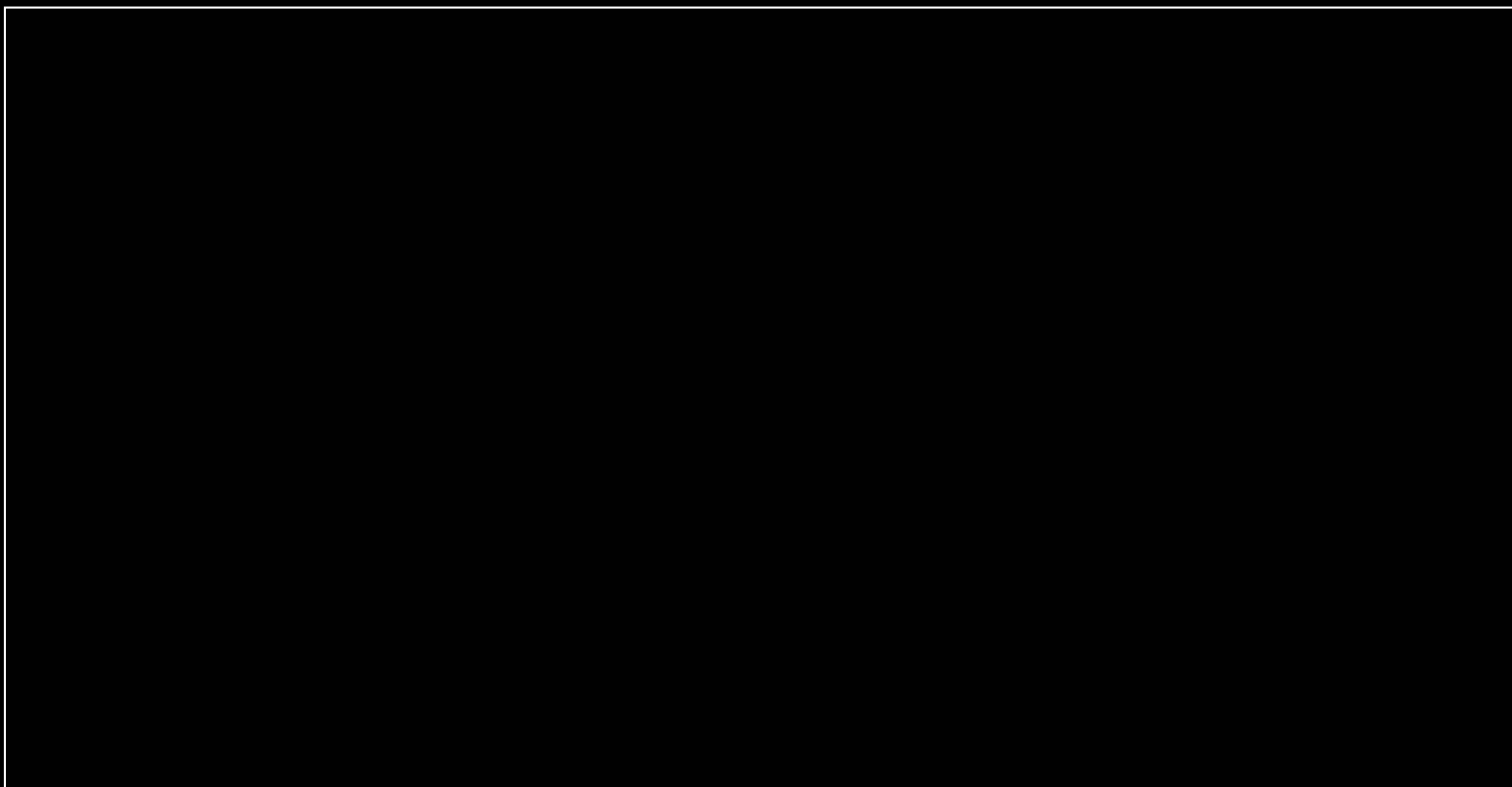

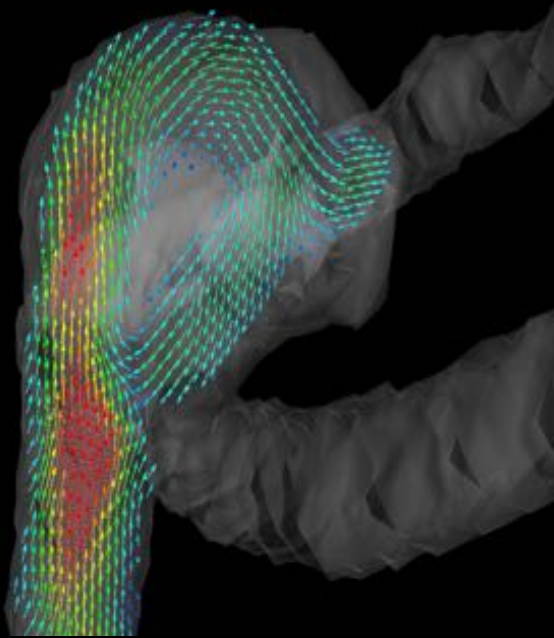

S. Kecskemeti et al., JMRI 2012

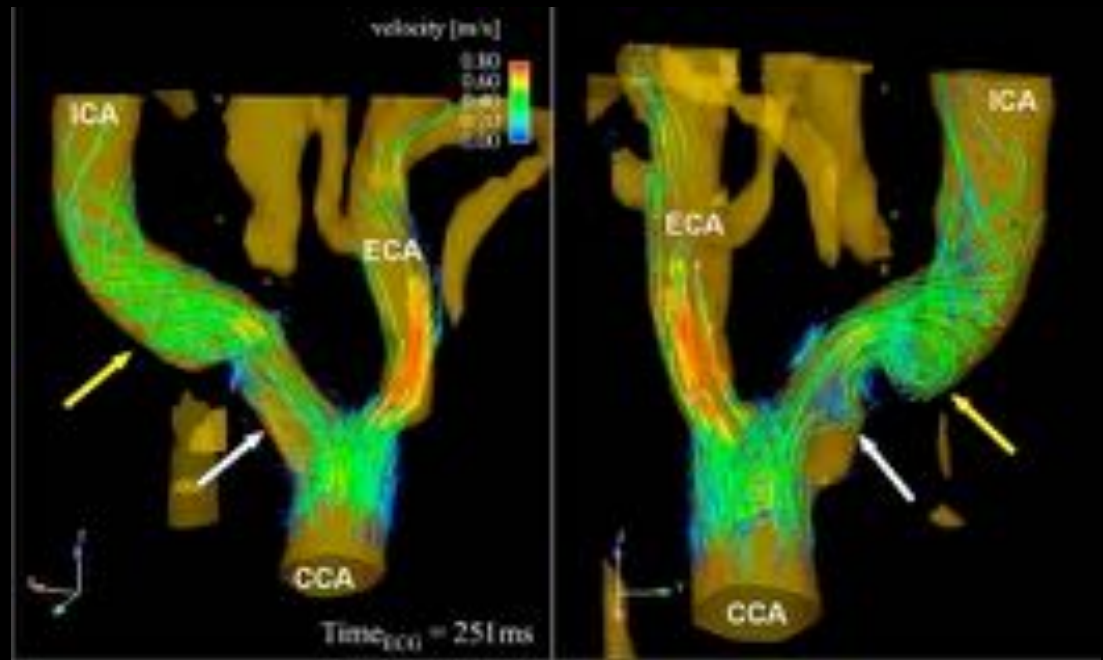

Harloff et al, *Perspectives in Medicine*, 2012

- Potential parameters from 4D flow acquisition

- Flow
- Pressure gradients (stenoses)
- Wall shear stress
- Pulse wave velocity
- Turbulent kinetic energy
- Reflux
- Resistance Index
- Vorticity/helicity
- Pulsatility
- ...

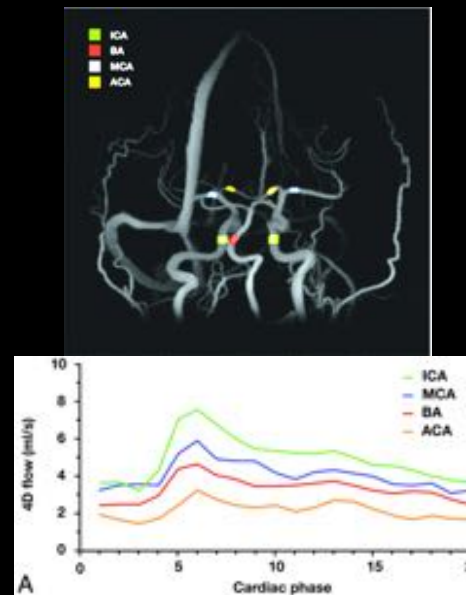

Wählin, et al *AJNR* 2013.

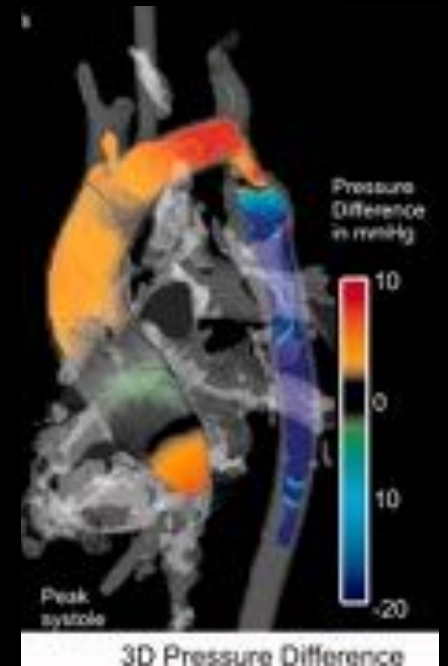

Bock, et al *MRM* 2011

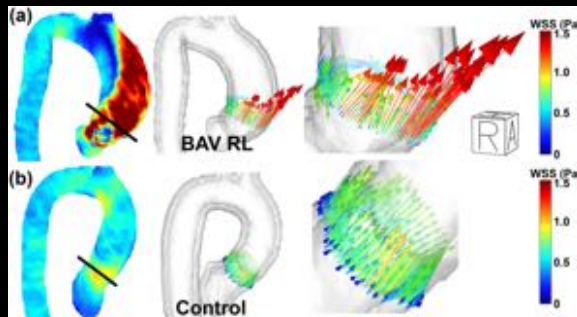

Van Ooij, et al *Annals BioEgr* 2014

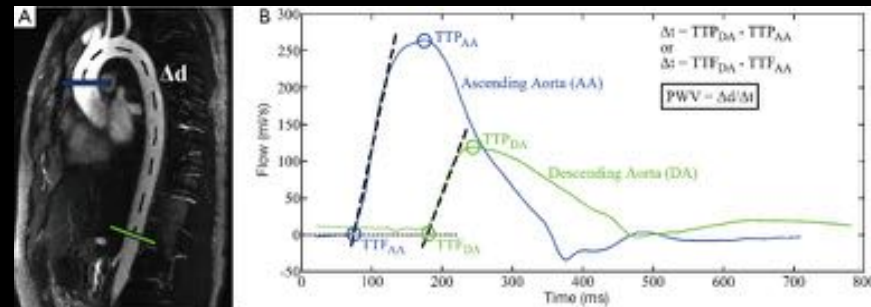

Wentland, et al. *Cardiovasc Diagn Ther* 2014

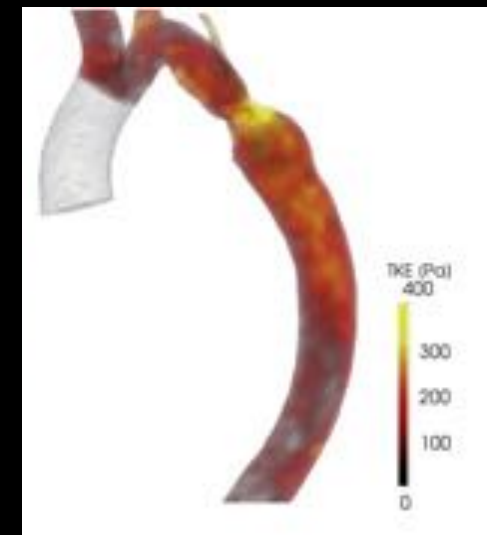

Lantz, et al *J Biomech* 2013

# Requirements

4-5 velocity encoding acquisitions  
+  
20+ timeframes  
+  
3D acquisition with large FOV  
=  
long scan times (1 hour +)  
or  
accelerate A LOT

# Parameter Selection



For any MRI protocol always ask yourself:

Why is *that* value chosen for *that* parameter?

# VENC Selection

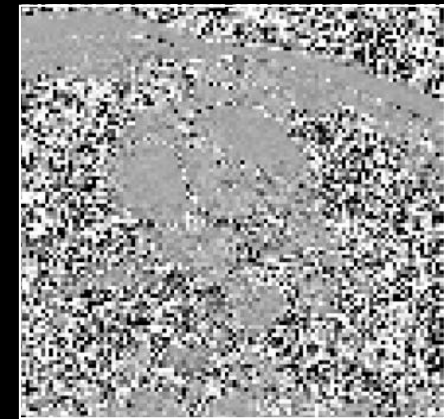
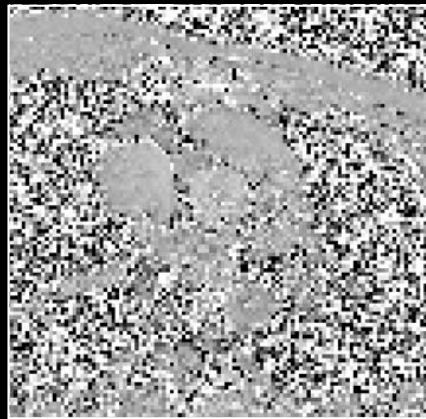
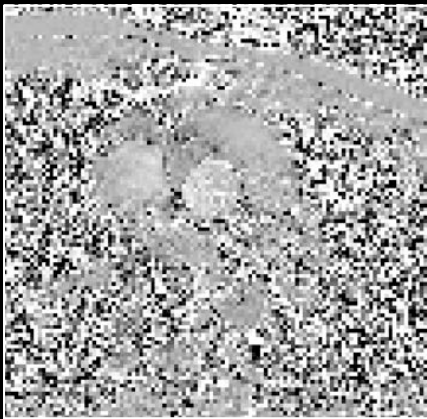
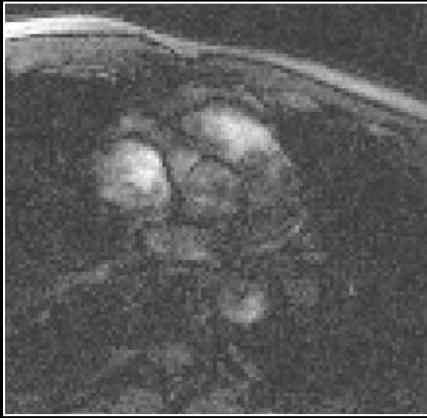

VENC=75cm/s

**VENC~1.2•v<sub>Max</sub>=150cm/s**

VENC=900cm/s

**Phase Wrapping**

Larger M<sub>1</sub>

Longer TE/TR (3.2/5.6ms)

Higher Sensitivity

No Phase Wrapping

Intermediate M<sub>1</sub>

Shorter TE/TR (2.4/4.8ms)

Intermediate Sensitivity

No Phase Wrapping

Smaller M<sub>1</sub>

Shorter TE/TR (2.3/4.6)

Lower Sensitivity

**Choose VENC to be ~1.2 the expected maximum velocity.**

# Chemical Shift Effects

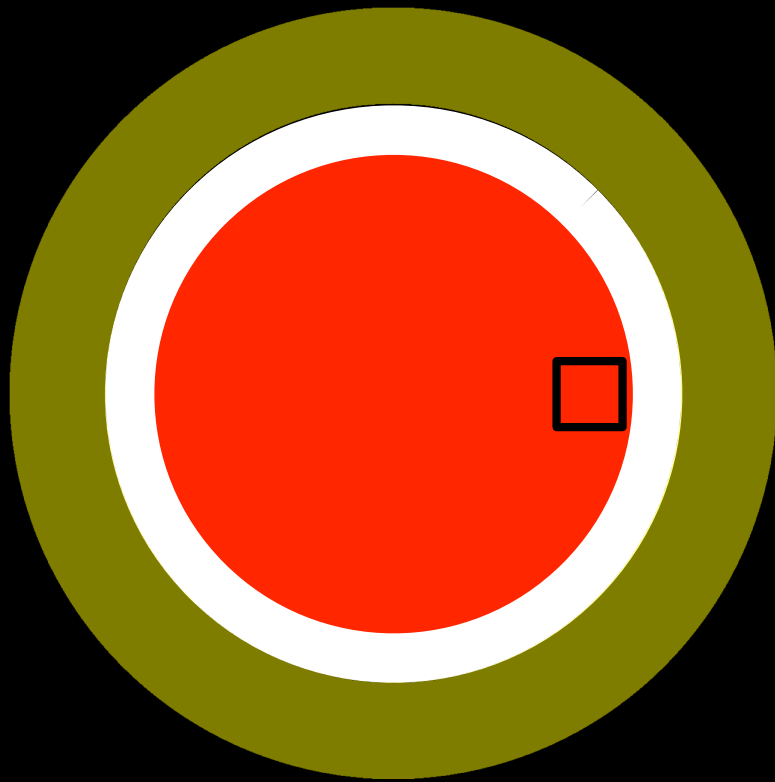

**Blood**   **Wall**   **Fat**

**Blood+Fat**   **Wall+Fat**

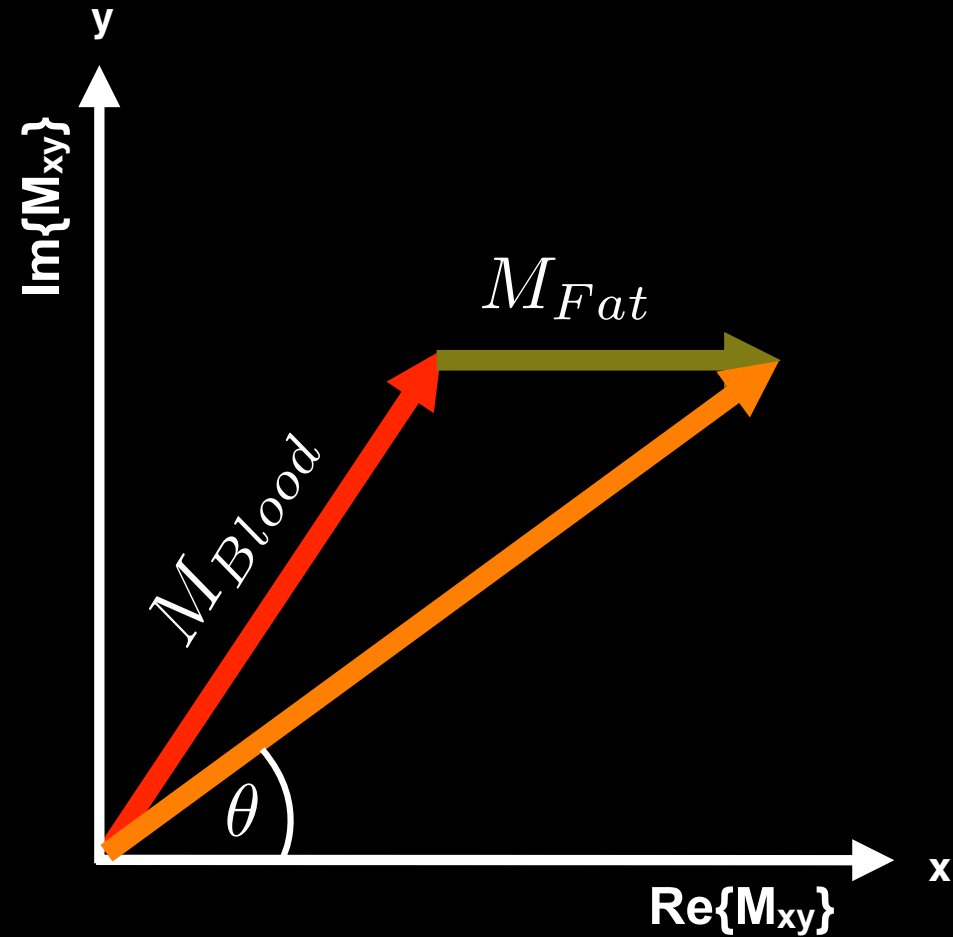

# Phase Contrast - Effect of Bandwidth

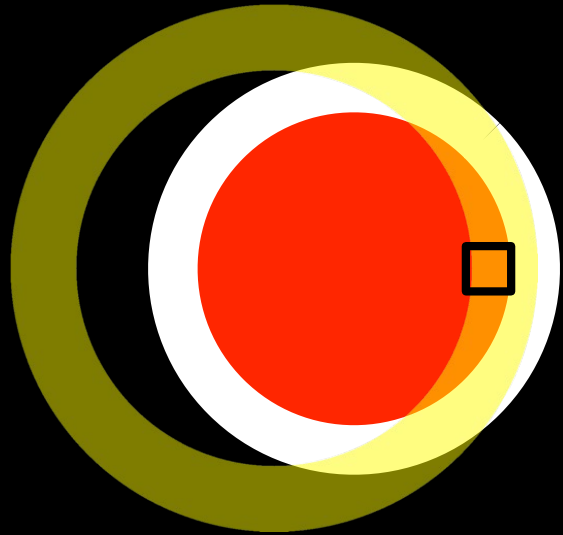

Low Bandwidth

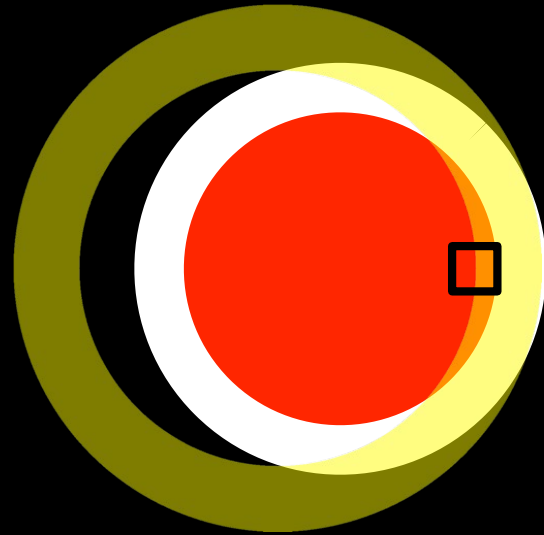

Mid Bandwidth

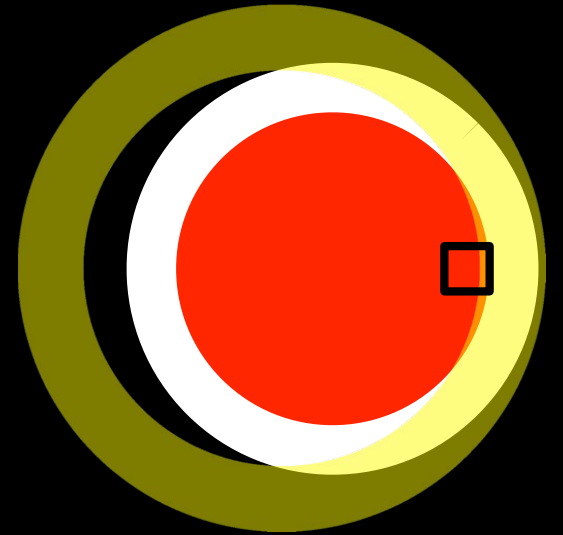

High Bandwidth

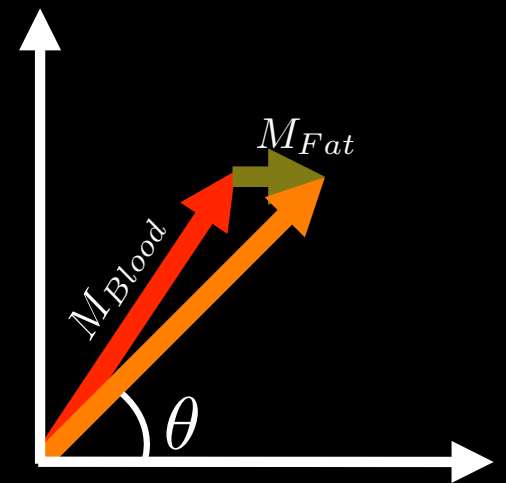
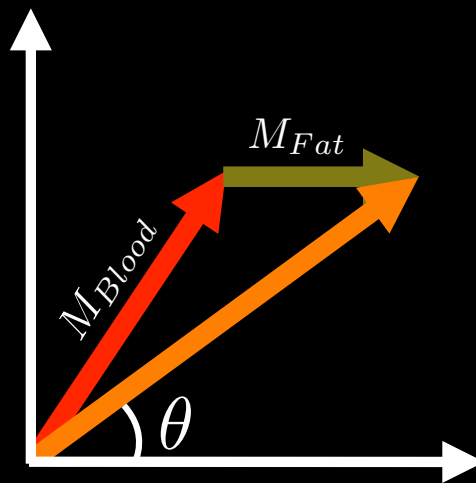
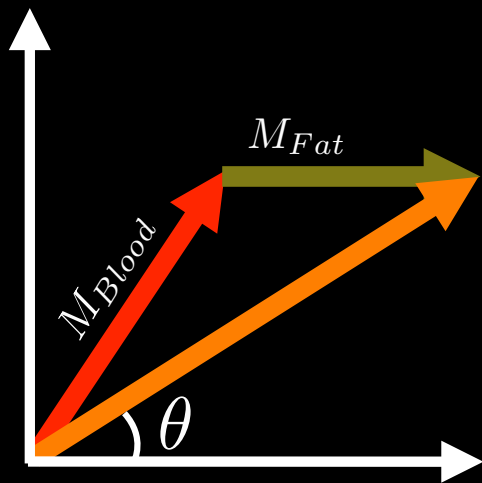

**Blood**

**Wall**

**Fat**

**Blood+Fat**

**Wall+Fat**

# Phase Contrast - Effect of TE

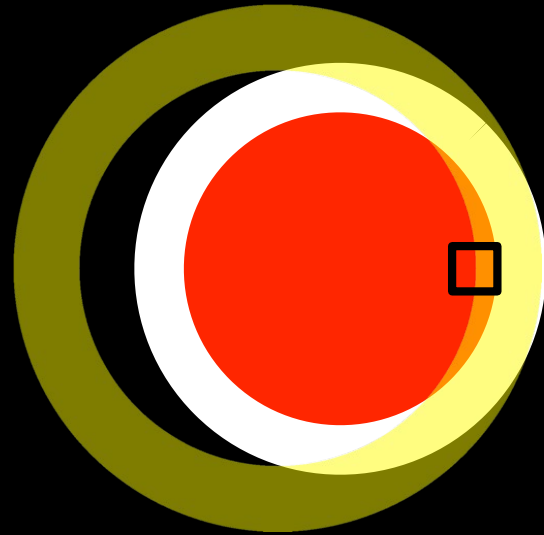

Mid Bandwidth

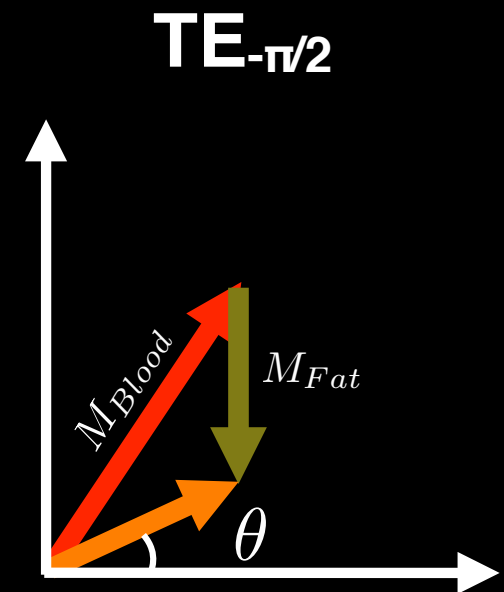
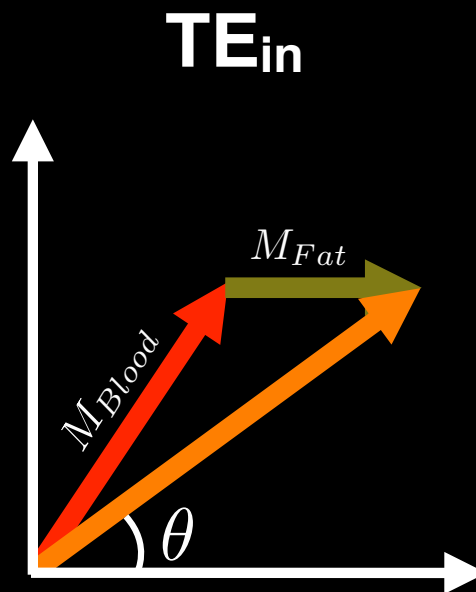
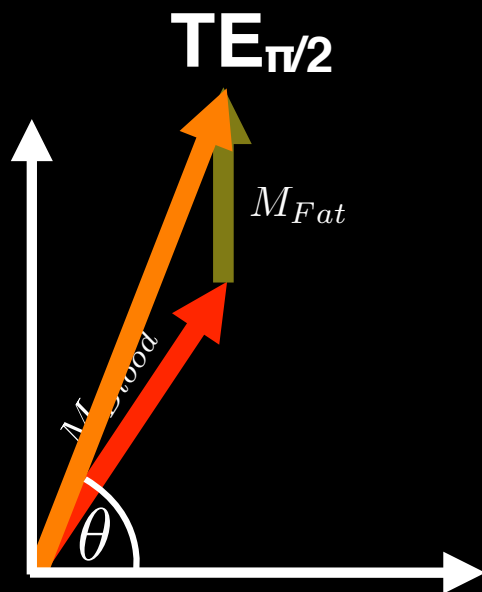

**Blood**

**Wall**

**Fat**

**Blood+Fat**

**Wall+Fat**

# How to pick BW and TE?

**Intermediate/high BW mitigates chemical shift errors.**

**In-phase TE mitigates chemical shift errors.**

**More important at 3T where off-resonance of fat is ~440Hz.**

# Readout Bandwidth

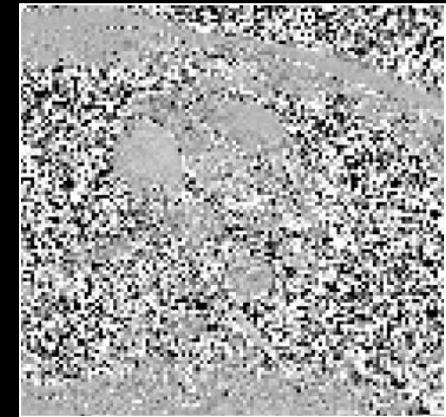
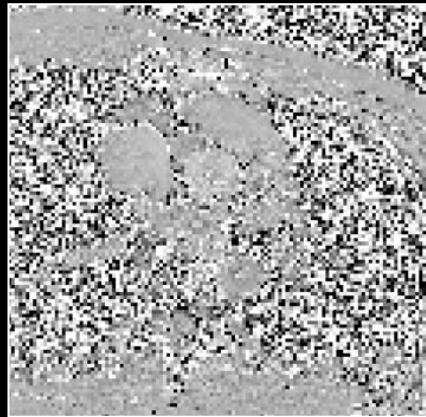
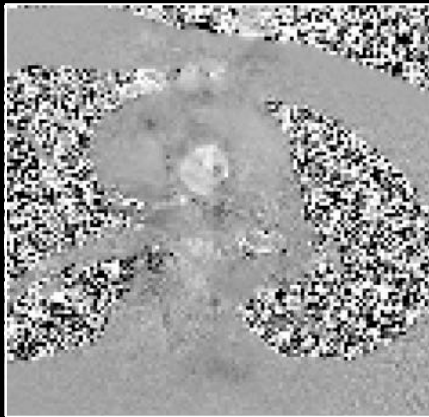
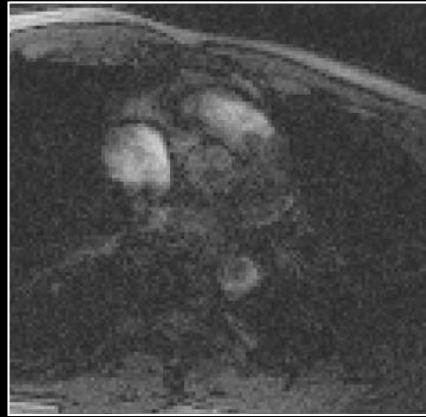

220Hz/Pixel= $\pm$ 21.1kHz

814Hz/Pixel= $\pm$ 78.1kHz

1532Hz/Pixel= $\pm$ 147.1kHz

~1 Pixel Chemical Shift  
Longer TE/TR (4.2/9.0)  
Higher SNR

~0.25 Pixel Chemical Shift  
Intermediate TE/TR (2.4/4.8)  
Intermediate SNR

~0.14 Pixel Chemical Shift  
Shorter TE/TR (2.3/4.3)  
Lower SNR

**Intermediate/high BW mitigates chemical shift errors.  
More important at 3T where off-resonance of fat is ~440Hz.**

# Flip Angle

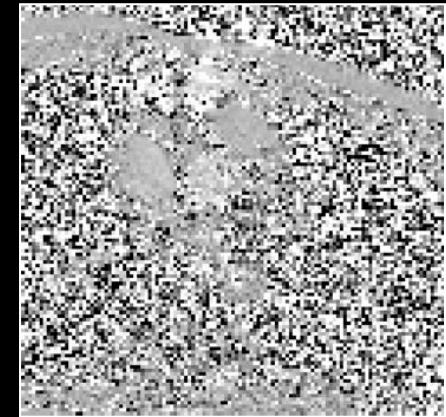
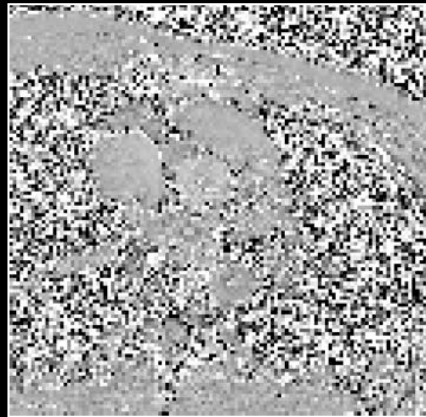
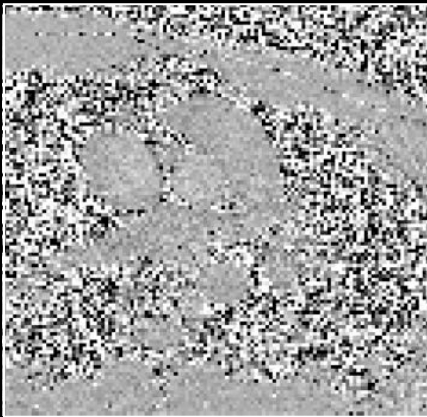
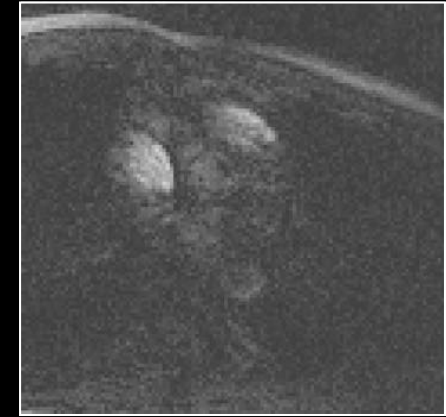

$FA = \alpha_{Ernst, Blood} = 5^\circ$

Poor Blood SNR  
Low SAR

$FA = 30^\circ$

Excellent Blood SNR  
Low SAR

$FA = 60^\circ$

Saturated Blood Signal  
High SAR

**Choose a flip angle greater than the Ernst angle due to in-flow effects.**



# Spatial Resolution

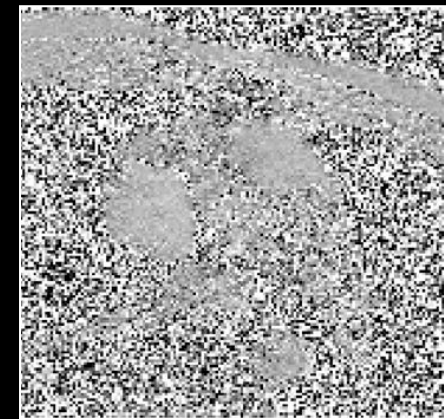
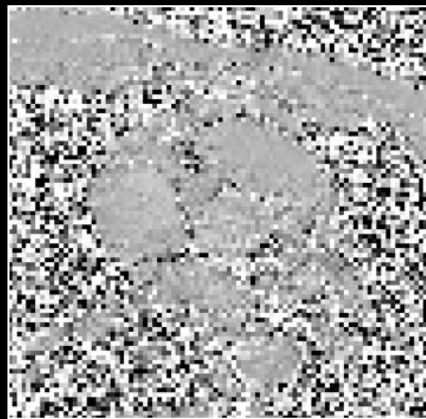
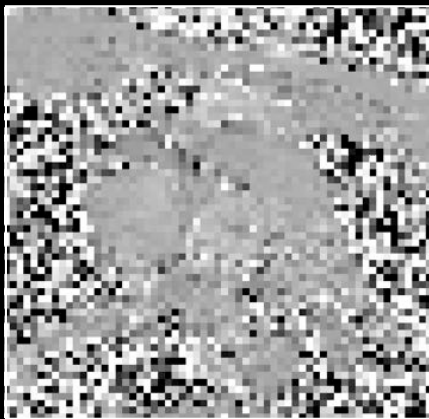

2.5mm x 2.5mm in-plane

1.7mm x 1.7mm in-plane

1.0mm x 1.0mm in-plane

Shorter breath holds  
Larger voxels  
Higher SNR

Intermediate breath holds  
Intermediate voxels  
Intermediate SNR

Longer breath holds  
Smaller voxels  
Lower SNR

**High spatial resolution needed for volume estimates.**

# Temporal Resolution

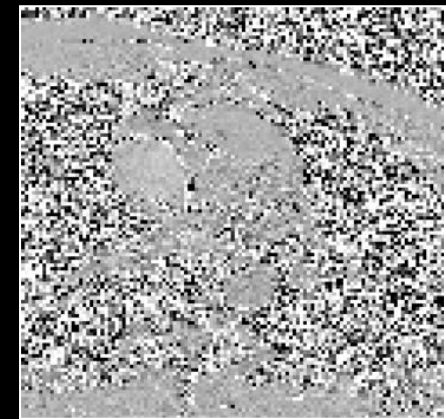
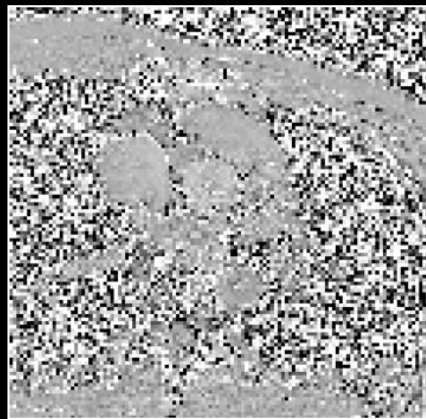
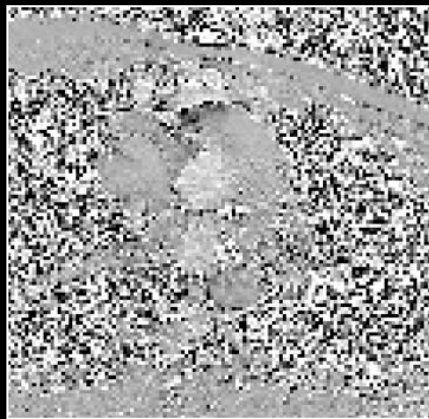
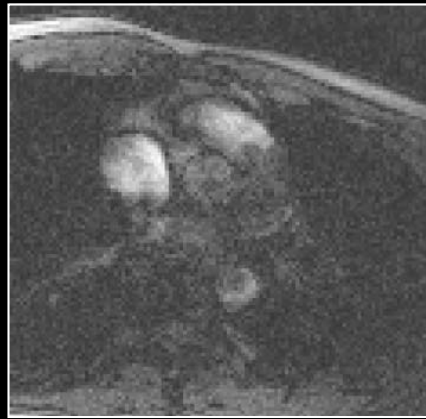

80ms/frame

40ms/frame

10ms/frame

Lower Temporal Resolution  
(80ms, VPS=8)

Intermediate Temp. Res.  
(40ms, VPS=4)

High Temporal Resolution  
(10ms, VPS=1)

Shorter Breath Holds (7s) Intermediate Breath Hold (14s) Long Breath Hold (56s)

**High temporal resolution needed for  $v_{Max}$  estimates.**

# Parallel Imaging

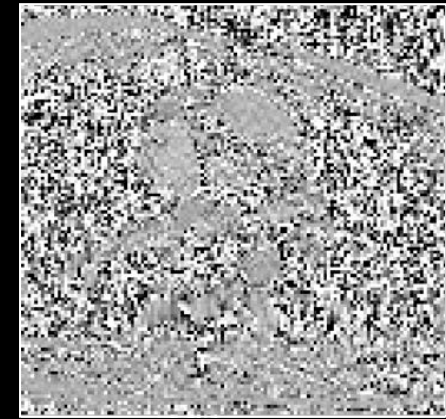
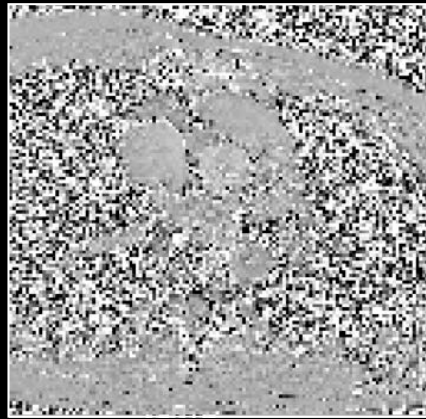
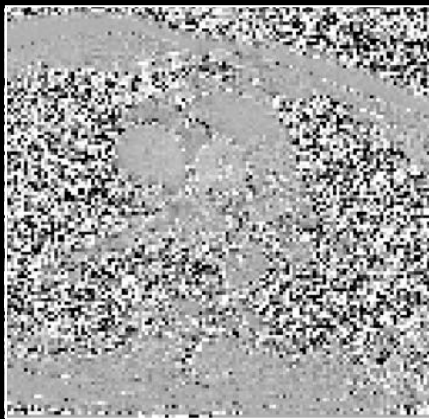
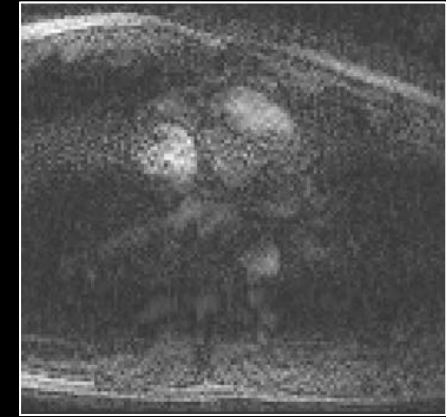
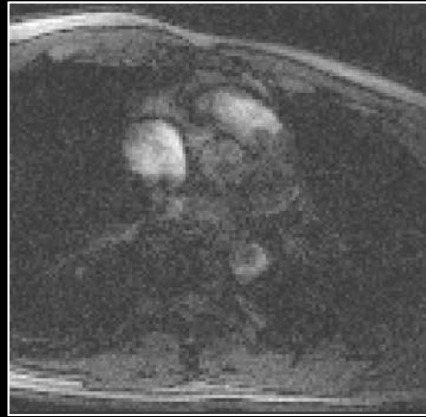
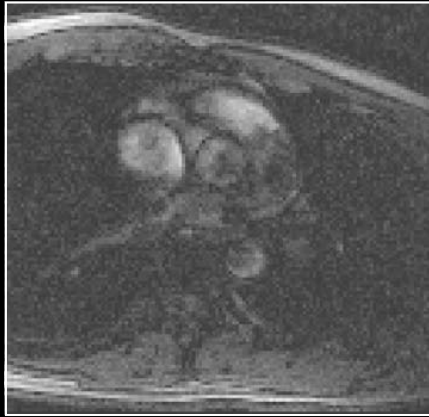

No Acceleration

~2x Acceleration

~8x Acceleration

Lower S/T Resolution  
Long Breath Holds  
Higher SNR

Intermediate S/T Resolution  
Intermediate Breath Holds  
Intermediate SNR

High S/T Resolution  
Short Breath Holds  
Low SNR & Artifacts

**2x acceleration widely used for 2D PC-MRI.**

# PC-MRI Summary

- **PC-MRI useful for estimating:**
  - **Peak velocity**
  - **Volumes of flow**
  - **Myocardial motion**
- **The protocol *must* be optimized for the application.**
- **Routine correction of eddy currents is important.**
- **Without attention to detail quantitative inaccuracies can foment clinical disinterest.**

# Diffusion Weighted Imaging

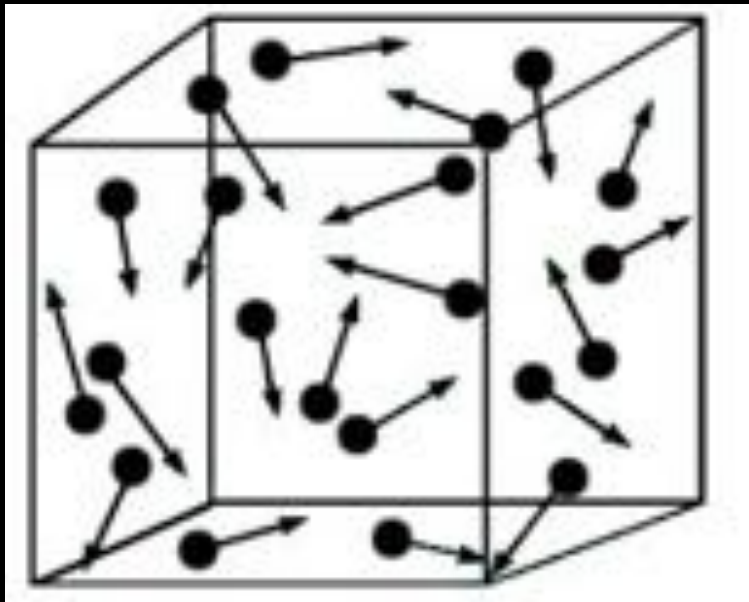

Random velocities + big bipolar  
= random phase  
= dephasing  
= signal loss

Signal loss is proportional to diffusion  
(directional measure like PC-MRI)  
so in the simplest terms:

Play a big M1 gradient, signal loss = diffusion

DWI

ADC

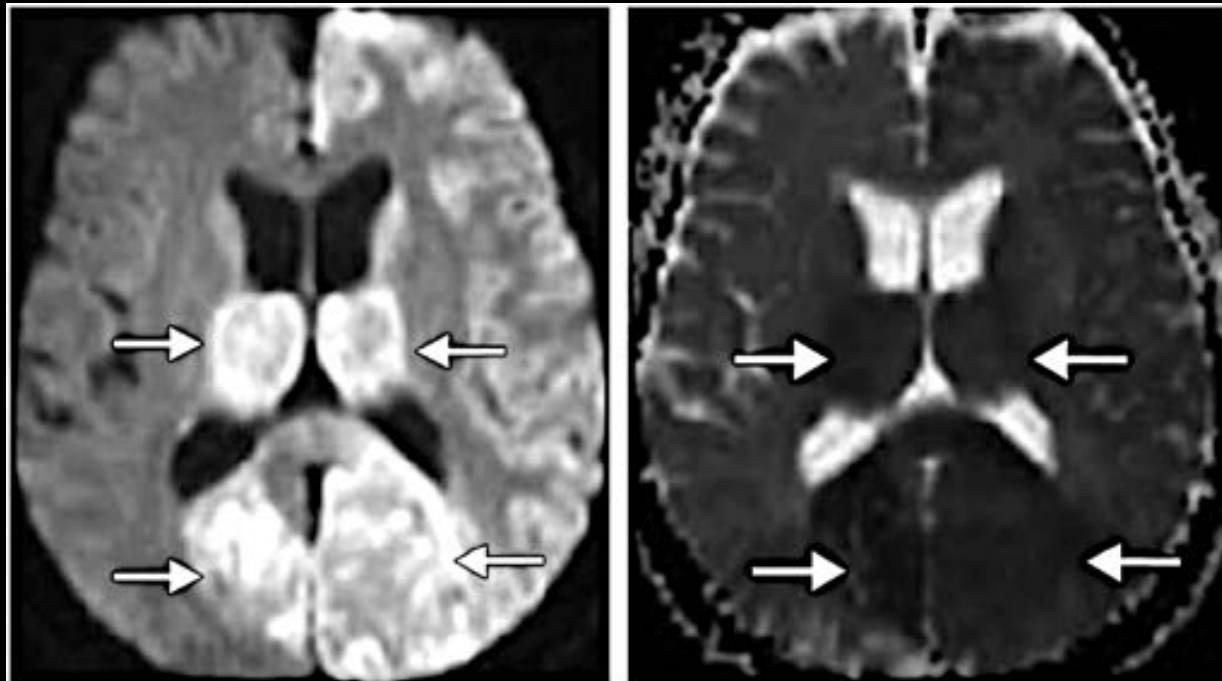

a. b.  
**Figure 15.** Acute stroke of the posterior circulation in a 77-year-old man. (a) Diffusion-weighted MR image ( $b = 1000 \text{ sec/mm}^2$ ) shows bilateral areas of increased signal intensity (arrows) in the thalami and occipital lobes. (b) ADC map shows decreased ADC values in the same areas (arrows). These findings are indicative of acute ischemia.

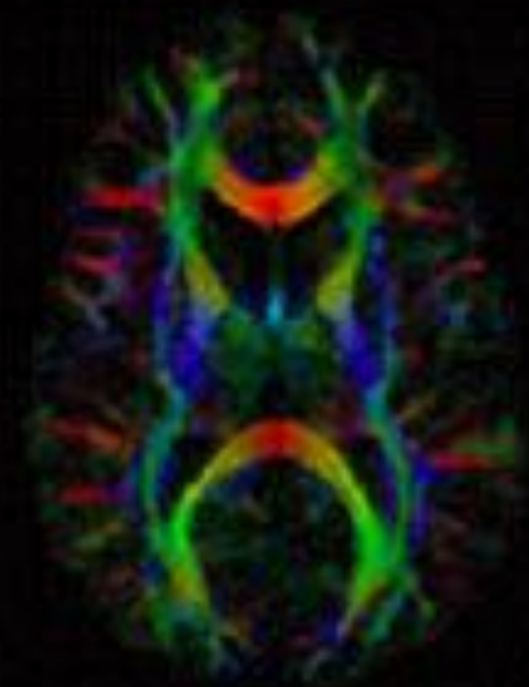

DTI

Srinivasan A, et al. State-of-the-art imaging of acute stroke. Radiographics 2006;26 Suppl 1:S75-95.

Thanks