

Spatial Localization I

M219 - Principles and Applications of MRI

Kyung Sung, Ph.D.

1/31/2022

Course Overview

- Course website
 - <https://mrri.ucla.edu/pages/m219>
- Course schedule
 - https://mrri.ucla.edu/pages/m219_2022
- Assignments
 - Homework #2 due on 2/14 by 5pm

Course Overview

- Office Hours

- TA (Ran Yan) - Tuesday 4-5pm

[https://uclahs.zoom.us/j/96870184581?](https://uclahs.zoom.us/j/96870184581?pwd=VkcZL0lyRkxsQ3FHcnIxQ1M2U3hPdZ09)

[pwd=VkcZL0lyRkxsQ3FHcnIxQ1M2U3hPdZ09](https://uclahs.zoom.us/j/96870184581?pwd=VkcZL0lyRkxsQ3FHcnIxQ1M2U3hPdZ09)

Password: 900645

- Instructor (Kyung Sung) - Friday 2-3pm

[https://uclahs.zoom.us/j/94058312815?](https://uclahs.zoom.us/j/94058312815?pwd=Tkl3ajhkamdGTnhqOVNnbk5RMnJGQT09)

[pwd=Tkl3ajhkamdGTnhqOVNnbk5RMnJGQT09](https://uclahs.zoom.us/j/94058312815?pwd=Tkl3ajhkamdGTnhqOVNnbk5RMnJGQT09)

Password: 888767

Spatial Localization

Spatial Encoding

- **Three key steps:**
 - **Slice selection**
 - You have to pick slice!
 - **Phase Encoding**
 - You have to encode 1 of 2 dimensions within the slice.
 - **Frequency Encoding (aka *readout*)**
 - You have to encode the other dimension within the slice.



3 Steps for Spatial Localization

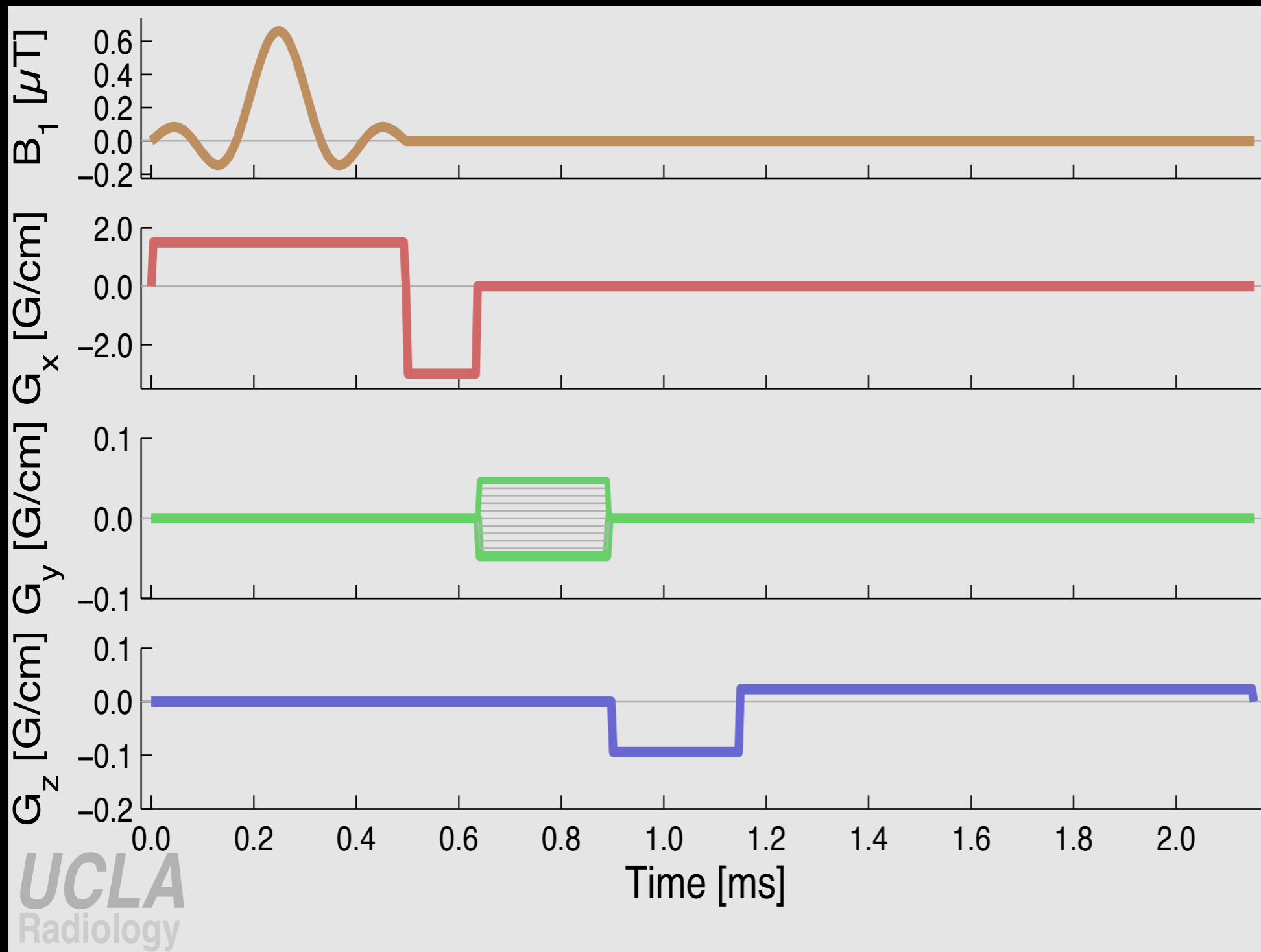

Slice Selection

Phase Encoding

Frequency Encoding

Pulse Sequence Diagram - Timing diagram of the RF and gradient events that comprise an MRI pulse sequence.

Slice Selection

- Consists of:
 - RF (B_1) Pulse
 - Contains frequencies matched to slice of interest
 - Slice selection gradient
 - Constant magnitude
 - Slice re-phasing gradient
 - Increases SNR
 - Re-phases spins within slice
 - AKA “slice refocusing gradient”
- **Permits exciting the slice of interest.**

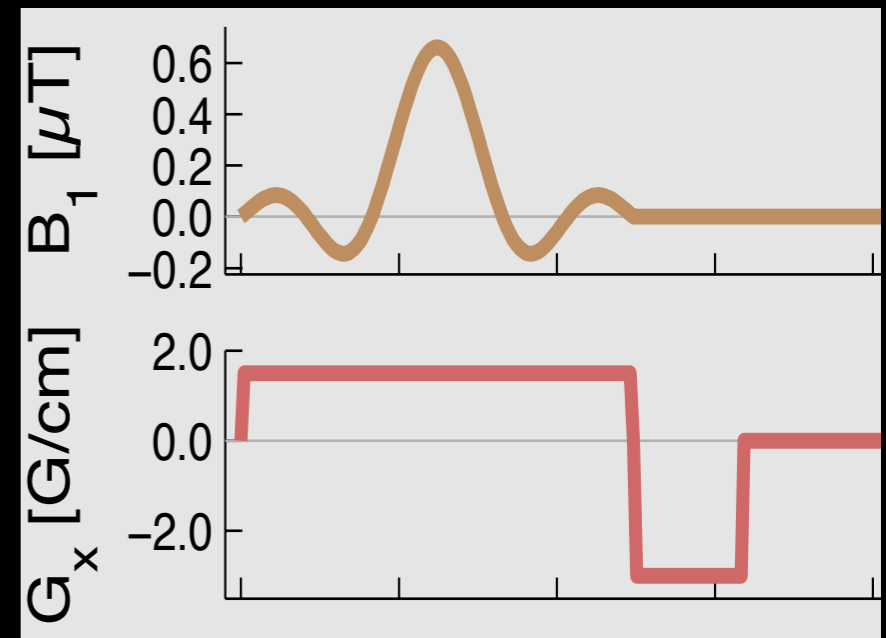

Excitation Pulses

RF Pulse - Excitation

$$B_1(t) = B_1^e(t) \left[\cos(\omega_{RF}t + \theta) \hat{i} - \sin(\omega_{RF}t + \theta) \hat{j} \right]$$

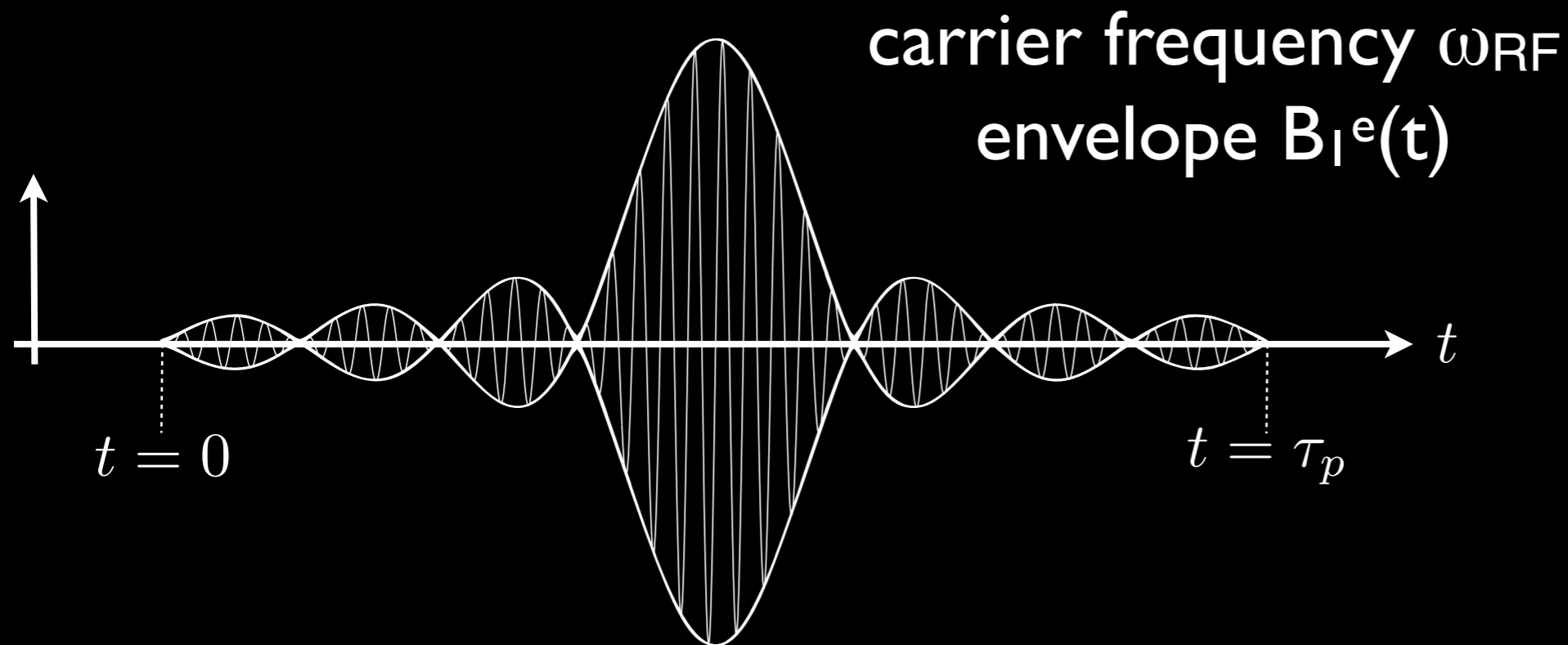

$$B_1^e(t) = \begin{cases} B_1 \text{sinc} [\pi f_\omega (t - \tau_p/2)], & 0 \leq t \leq \tau_p \\ 0, & \text{otherwise} \end{cases}$$

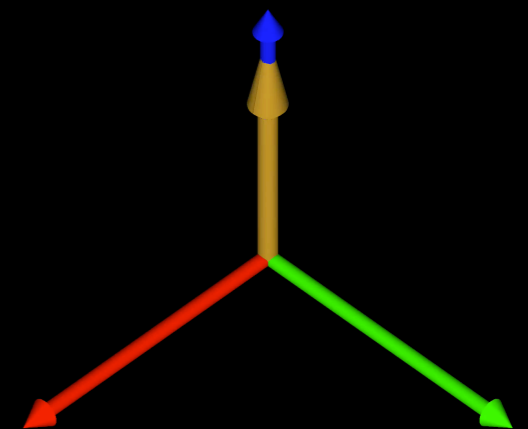

SINC functions are used to excite a narrow band of frequencies.

Excitation Pulses

- **Tip M_z into the transverse plane**
- **Typically $200\mu\text{s}$ to 5ms**
- **Non-uniform across slice thickness**
 - Imperfect slice profile
- **Non-uniform within slice**
 - Termed **B_1 inhomogeneity**
 - Non-uniform signal intensity across FOV

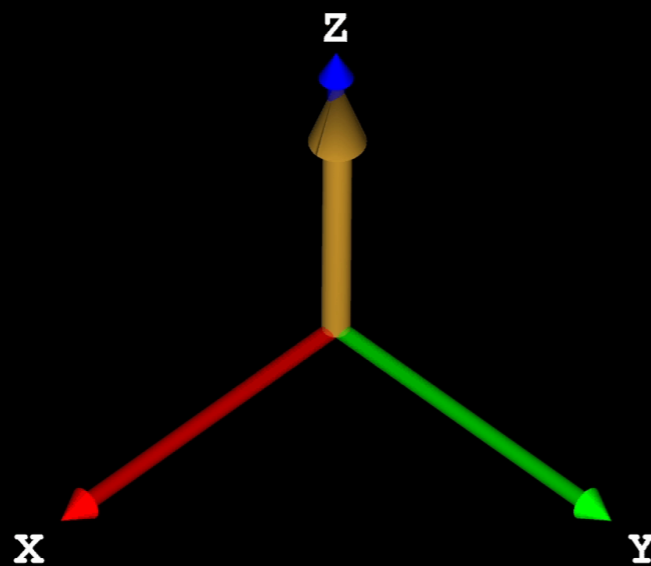

90° Excitation Pulse

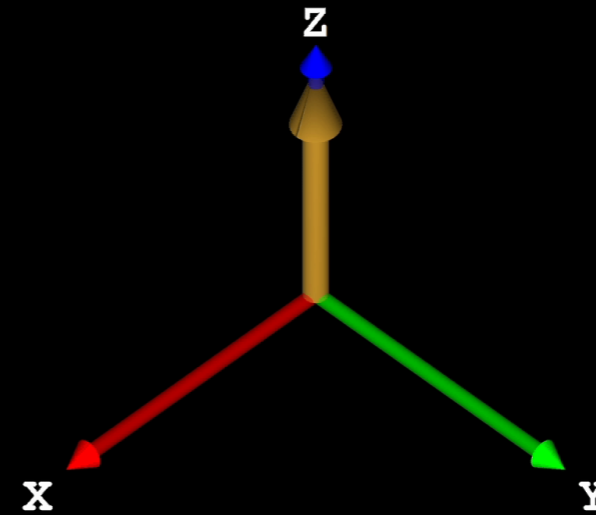

Small Flip Angle Pulse

Selective Excitation

Selective Excitation

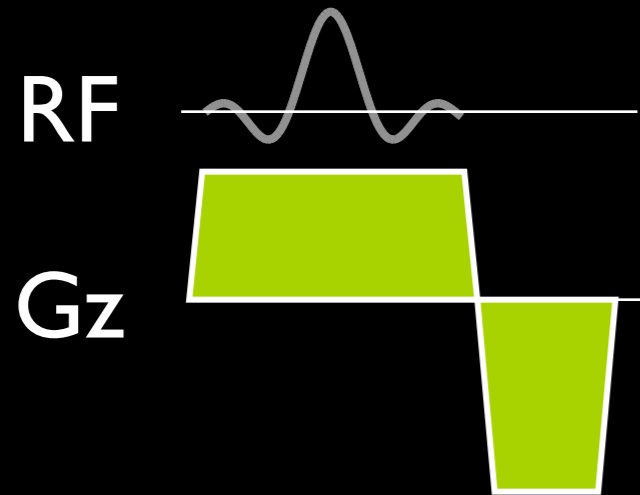

excite a slice perpendicular to z

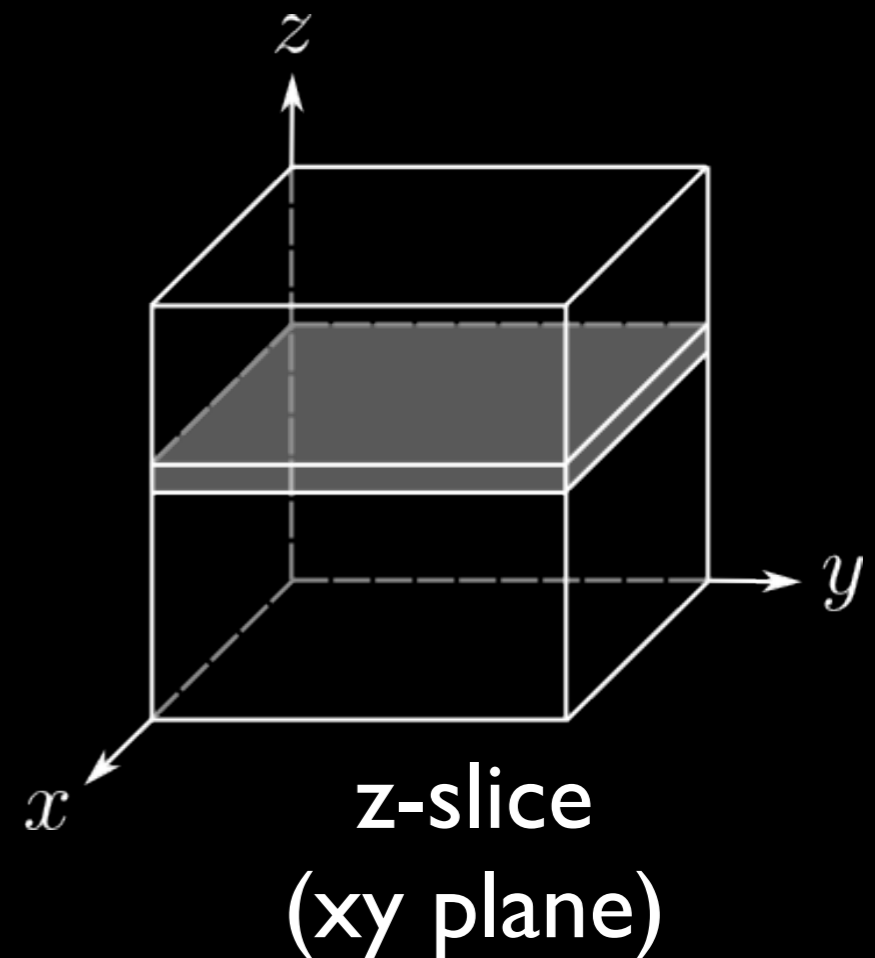
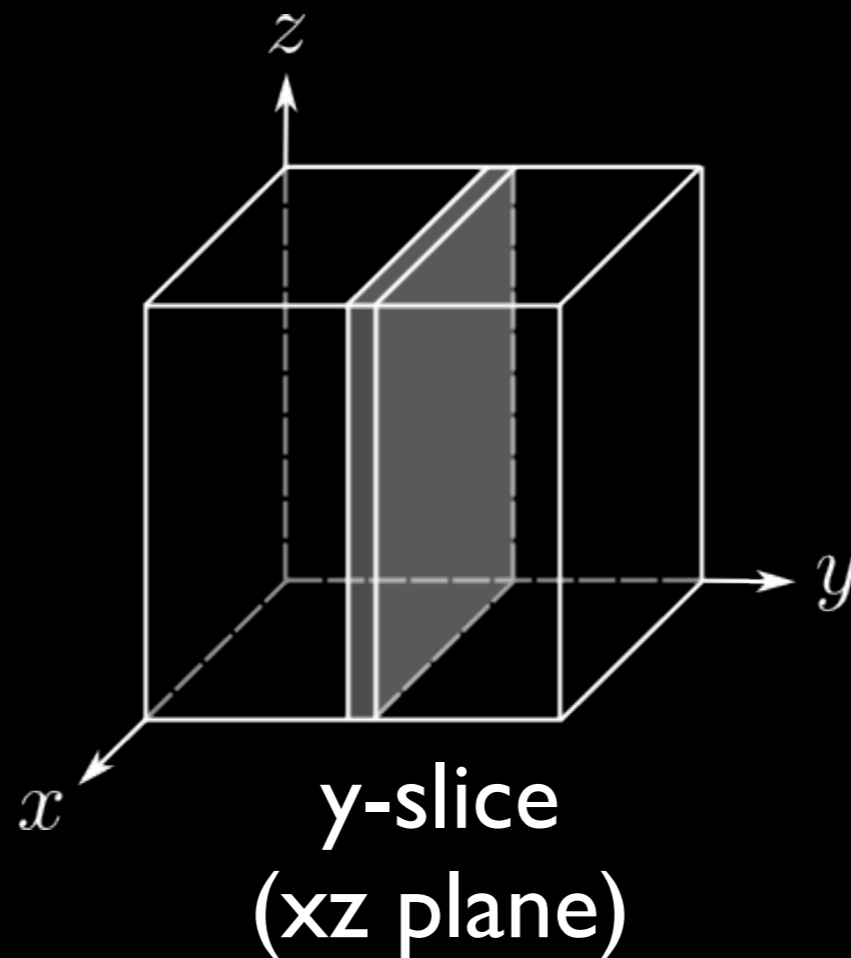
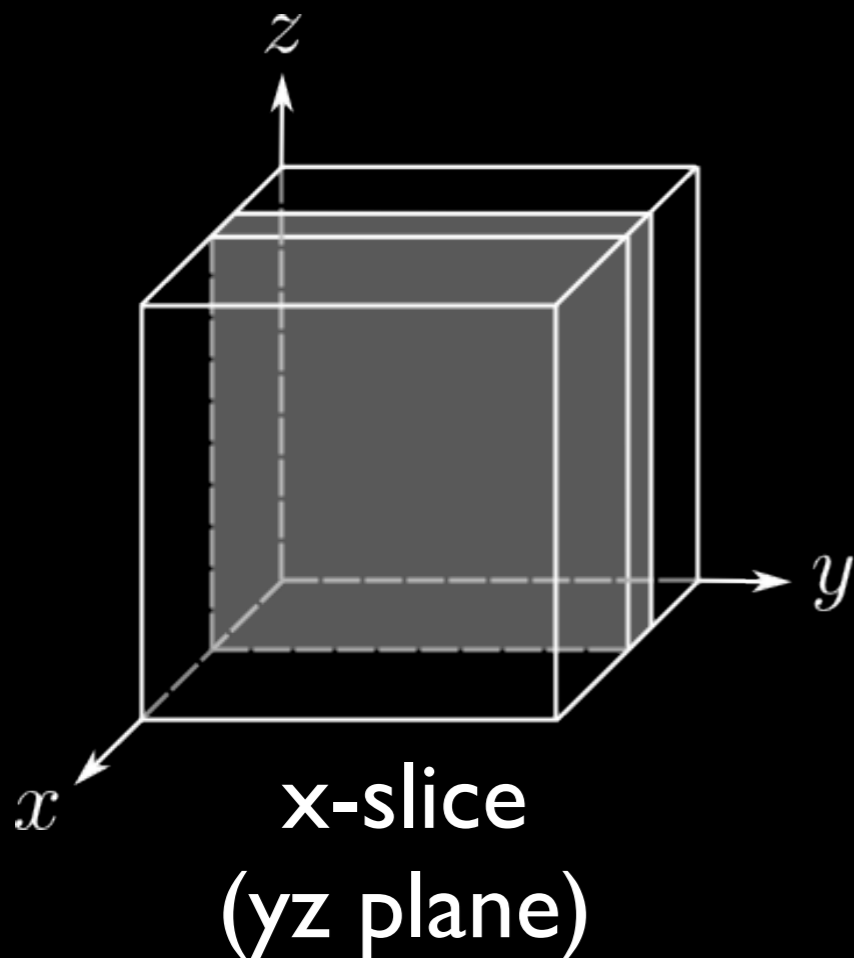

Gradients?

gradients produce a spatial distribution of frequencies

$$B_z(z) = B_0 + G_z \cdot z$$

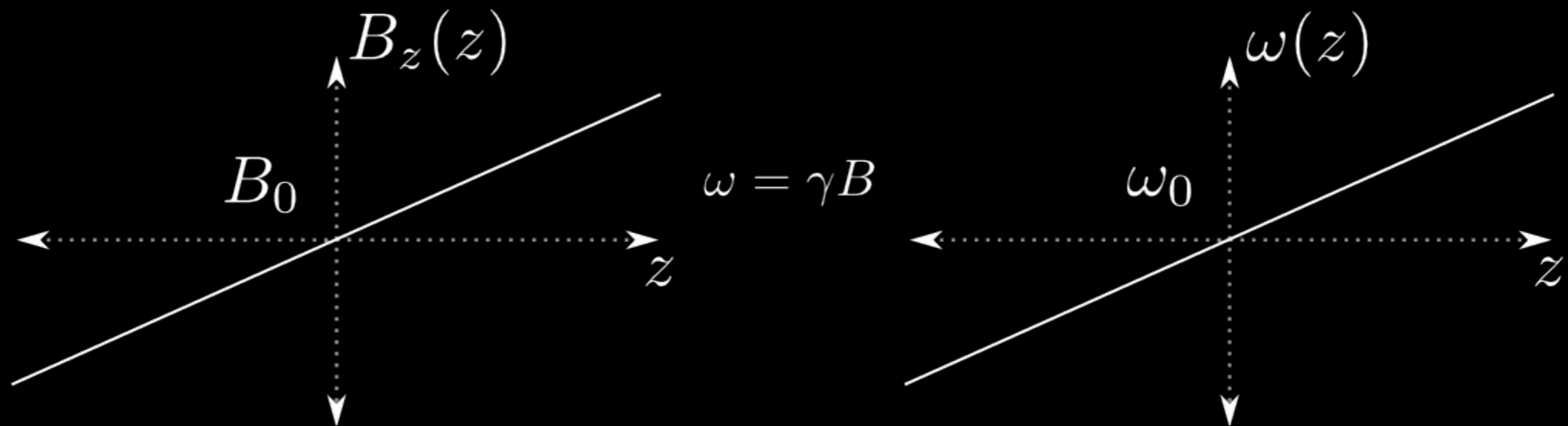

$$\omega(z) = \omega_0 + \gamma G_z \cdot z$$

there is a direct correspondence between
frequency and spatial position

Bloch Equation with Gradient

$$\frac{d\vec{M}_{rot}}{dt} = \vec{M}_{rot} \times \gamma \vec{B}_{eff}$$

$$\vec{B}_{eff} = \begin{pmatrix} B_1(t) \\ 0 \\ B_0 - \frac{\omega_{RF}}{\gamma} \end{pmatrix} \rightarrow \vec{B}_{eff} = \begin{pmatrix} B_1(t) \\ 0 \\ B_0 - \frac{\omega_{RF}}{\gamma} + G_z z \end{pmatrix}$$

Bloch Equation (at on-resonance)

$$\frac{d\vec{M}_{rot}}{dt} = \vec{M}_{rot} \times \gamma \vec{B}_{eff}$$

where $\vec{B}_{eff} = \begin{pmatrix} B_1(t) \\ 0 \\ \cancel{B_0} - \frac{\omega_{RF}}{\gamma} + G_z z \end{pmatrix}$

$$\frac{d\vec{M}}{dt} = \begin{pmatrix} 0 & \omega(z) & 0 \\ -\omega(z) & 0 & \omega_1(t) \\ 0 & -\omega_1(t) & 0 \end{pmatrix} \vec{M}$$

$$\omega(z) = \gamma G_z z \quad \omega_1(t) = \gamma B_1(t)$$

To the board ...

Slice Selection

how do we “excite” a certain slice?

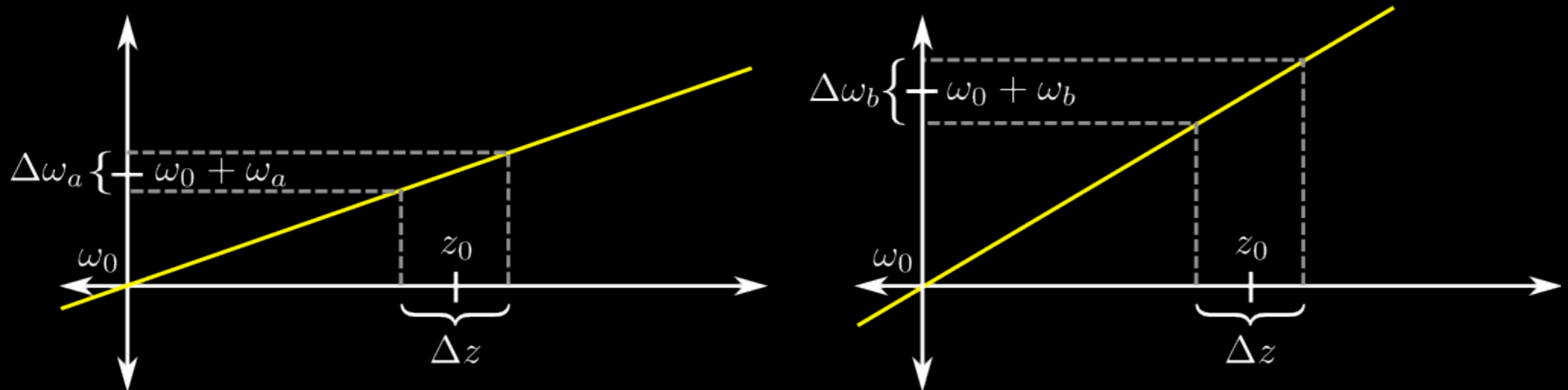

the strength of the gradient affects all parameters for the same spatial location

$$\Delta\omega_a < \Delta\omega_b$$

$$\omega_a < \omega_b$$

Slice Selection

how do we physically set the parameters?

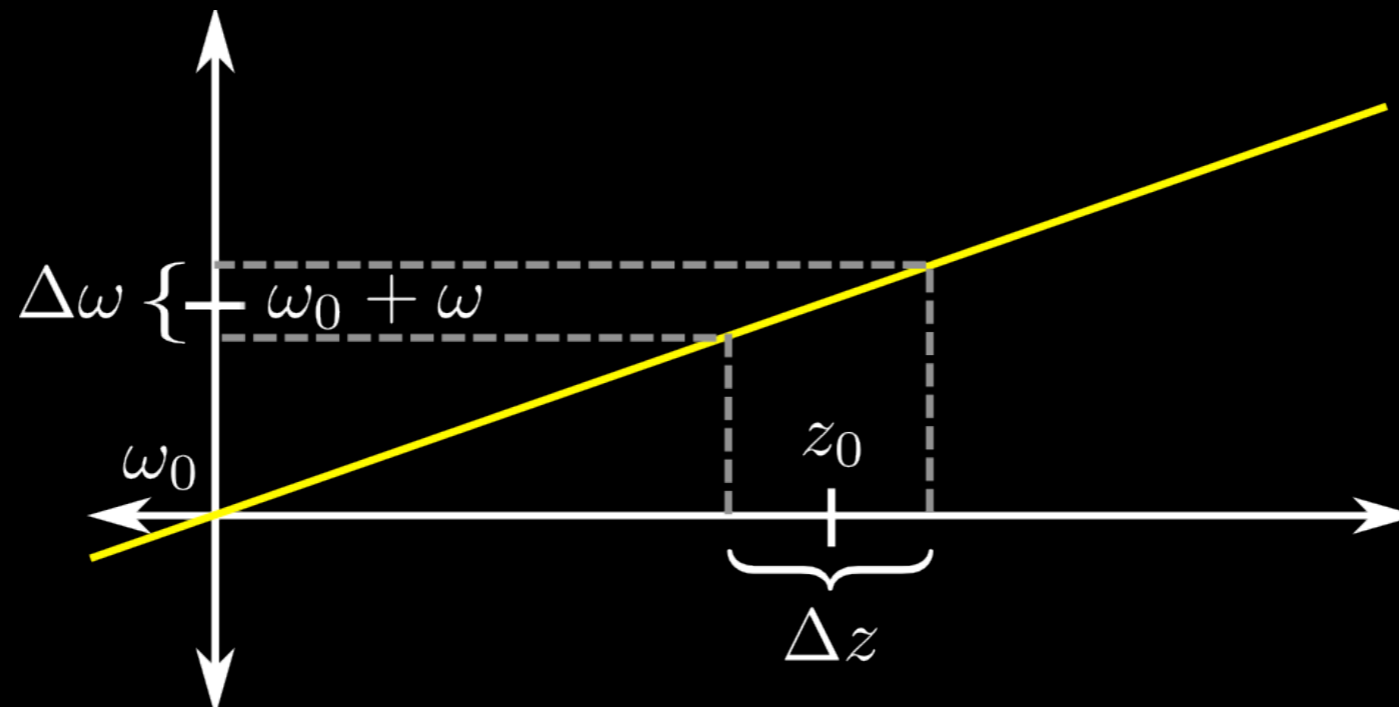

ω - the carrier frequency of the RF pulse

$\Delta\omega$ - frequency bandwidth of the RF pulse

Slice Selection

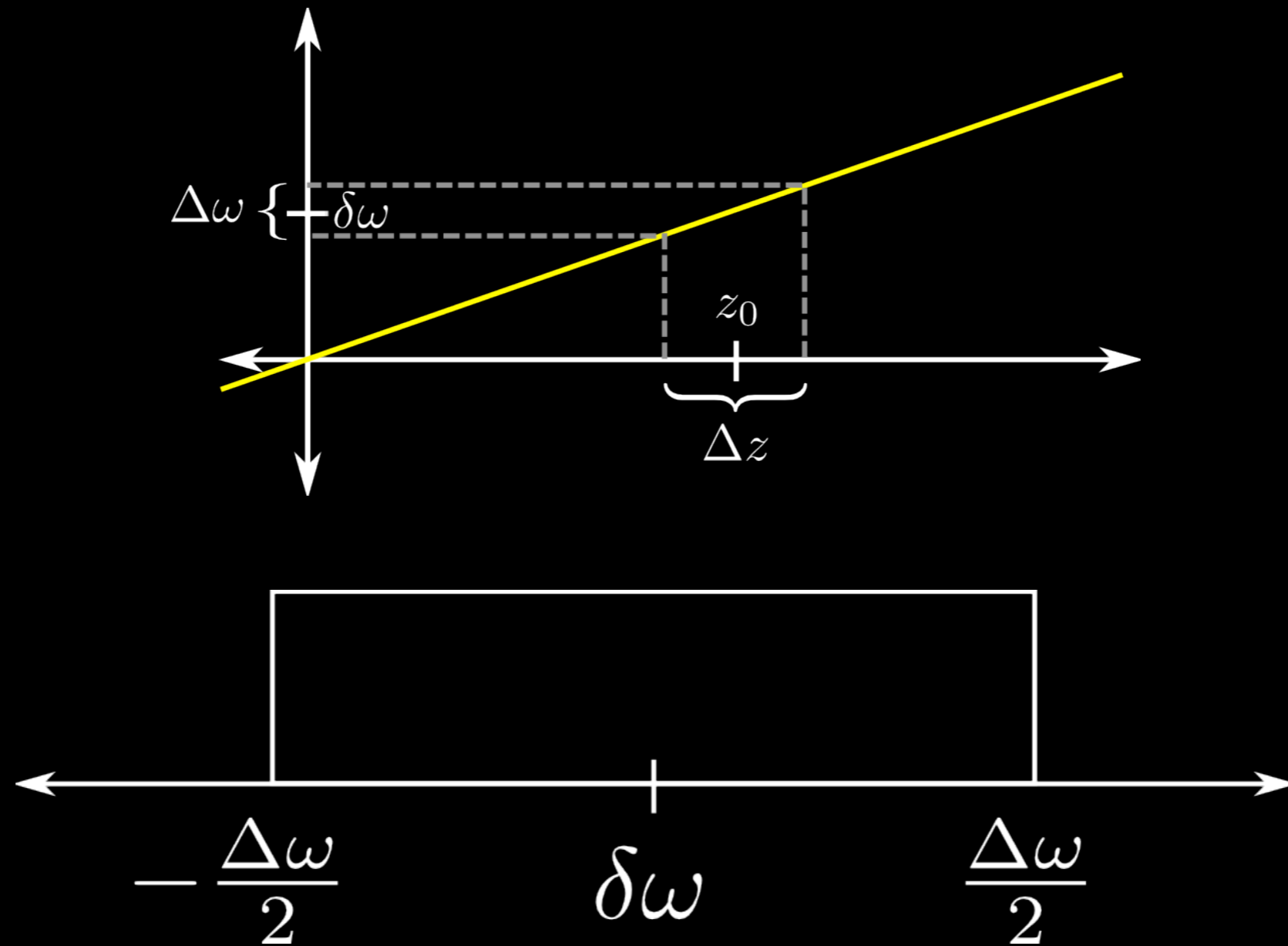

we want a pulse with as rectangular of an slice profile as possible

Selective Excitation

changing the shape of the pulse affects
the bandwidth of excitation

how do we know which shape to use?

small angle approximation

We will show the slice profile depends on

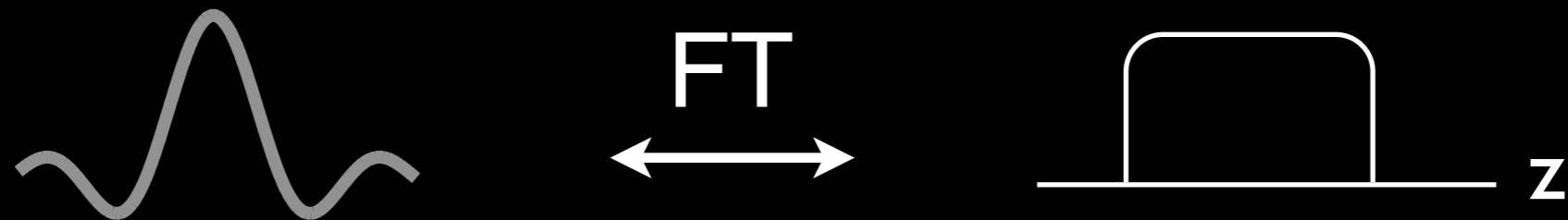

Slice Selective Excitation

$$\Delta\omega = -\gamma (G_z \cdot \Delta z)$$

Excitation Bandwidth

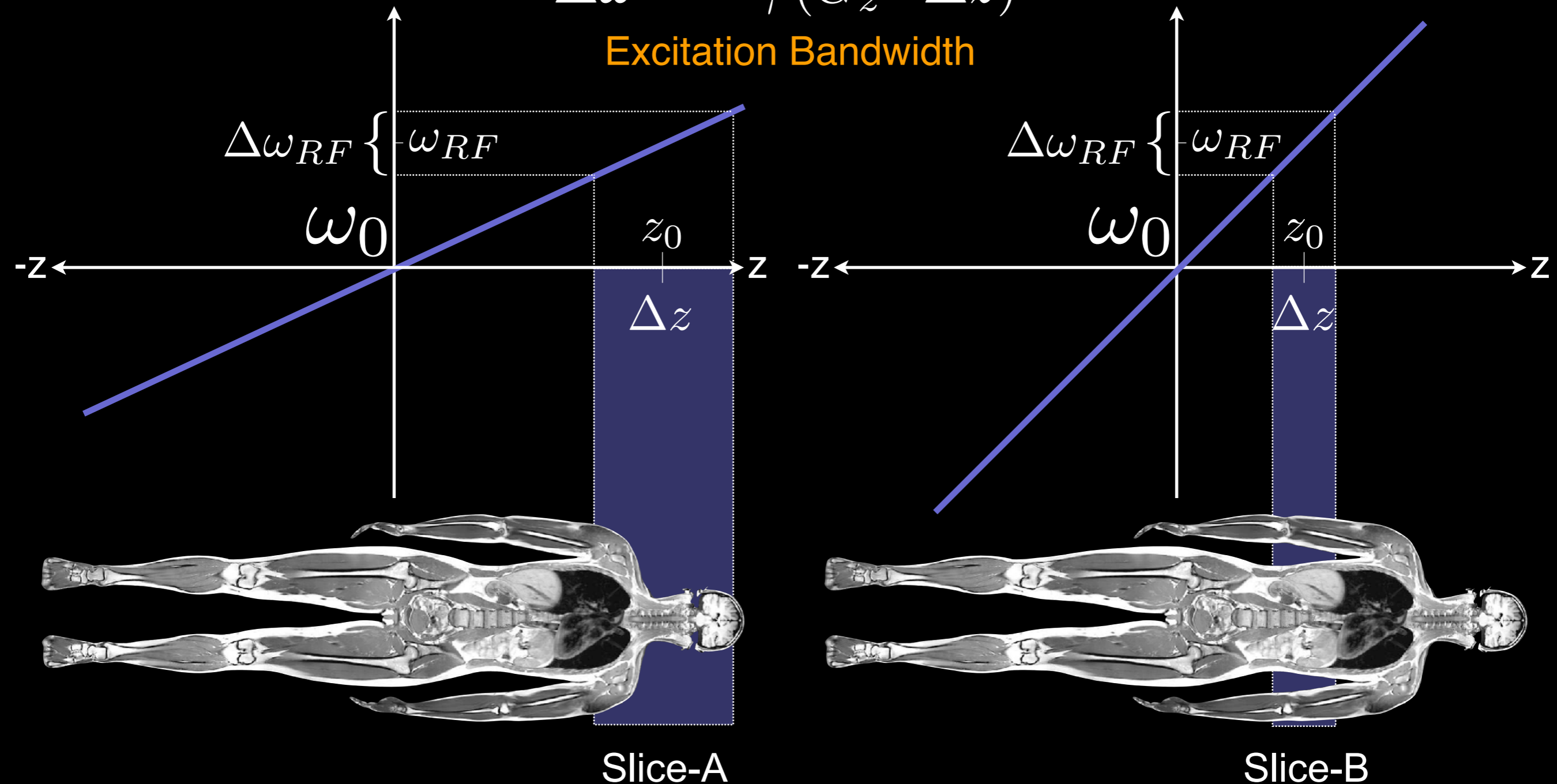

How do you move the slice along $\pm z$?
Compare $\Delta\omega$ and ω_{RF} for Slice-A and Slice-B.
Do we usually acquire $\omega_{RF} > \omega_0$?

Time Bandwidth Product (TBW)

- **Time bandwidth (TBW) product:**
 - **Pulse Duration [s] x Pulse Bandwidth [Hz]**
 - **Unitless**
 - **# of zero crossings**
 - **High TBW**
 - Large # of zero crossings \therefore fewer truncation artifacts
 - Longer duration pulse
- **Examples:**
 - **TBW = 4, RF = 1ms**
 - Excitation (RF) bandwidth?
 - Required G_z for 1cm slice?
 - **TBW = 16, RF = 1ms**
 - Excitation (RF) bandwidth?
 - Required G_z for 1cm slice?

Slice Selective Excitation - Example

$$\Delta\omega_{RF} = -\gamma (G_z \cdot \Delta z) \quad \text{Excitation Bandwidth}$$

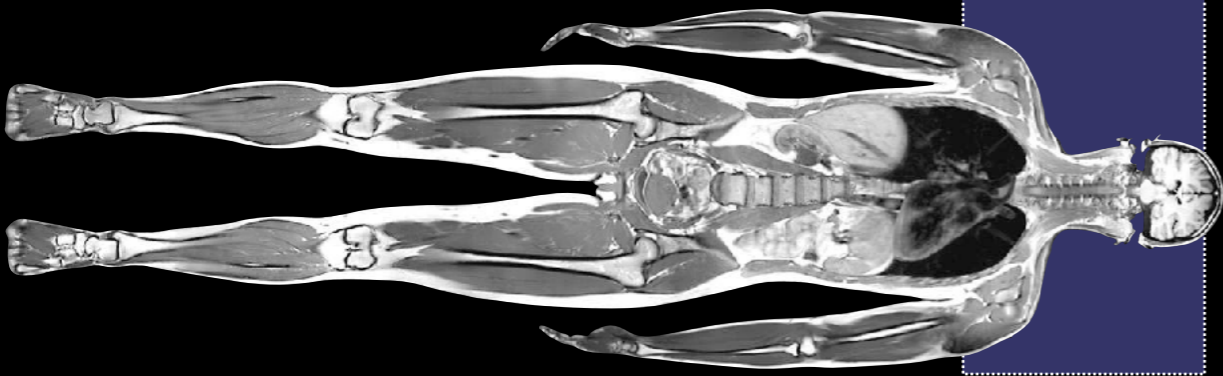
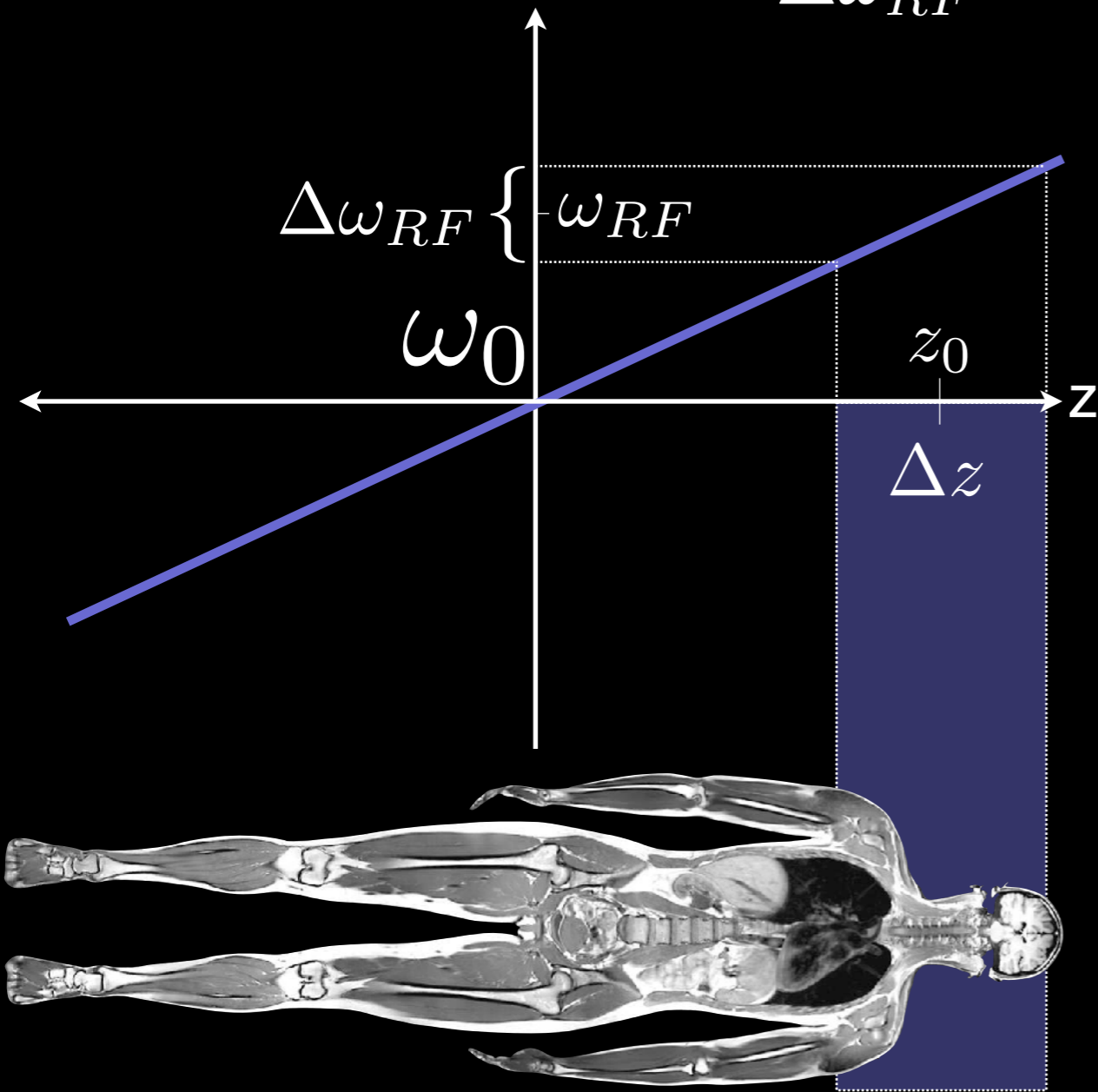

Slice-A

$$TBW = \tau_{RF} \cdot \Delta\omega_{RF}$$

$$\begin{aligned} \Delta\omega_{RF} &= \frac{TBW}{\tau_{RF}} \\ &= \frac{4}{1\text{ms}} \\ &= 4\text{kHz} \end{aligned}$$

$$G_z = \frac{\Delta\omega_{RF}}{\gamma \Delta z}$$

$$\begin{aligned} &= \frac{4000\text{Hz}}{42.57\text{e6} \frac{\text{Hz}}{\text{T}} \frac{1\text{T}}{10000\text{G}} \cdot 10\text{mm}} \\ &= 0.94 \frac{\text{G}}{\text{cm}} \end{aligned}$$

Selective Excitation

- What factors control slice selection?

$$B_1^e(t)$$

Pulse envelope function
(e.g. $B_{1,max}$ and $\Delta\omega$)

$$\omega_{RF}$$

Excitation carrier frequency

BW

RF pulse bandwidth

$$\vec{G}$$

Gradient amplitude

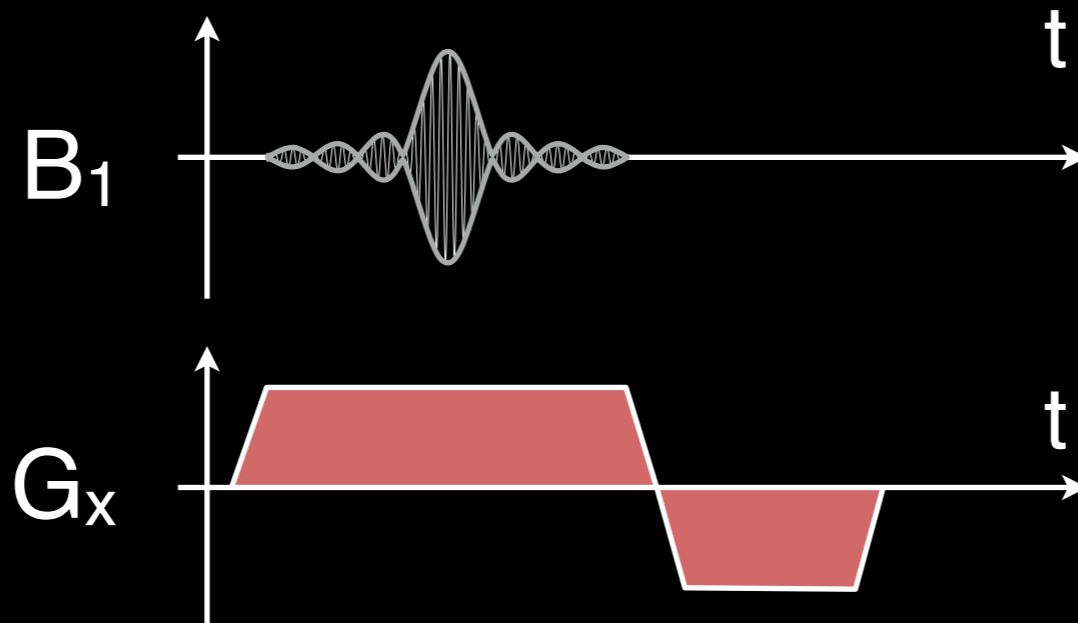

RF Pulse Bandwidth and Slice Profile: Small Tip Angle Approximation

Bloch Equation (at on-resonance)

$$\frac{d\vec{M}_{rot}}{dt} = \vec{M}_{rot} \times \gamma \vec{B}_{eff}$$

where $\vec{B}_{eff} = \begin{pmatrix} B_1(t) \\ 0 \\ \cancel{B_0} + \frac{\omega}{\gamma} + G_z z \end{pmatrix}$

When we simplify the cross product,

$$\frac{d\vec{M}}{dt} = \begin{pmatrix} 0 & \omega(z) & 0 \\ -\omega(z) & 0 & \omega_1(t) \\ 0 & -\omega_1(t) & 0 \end{pmatrix} \vec{M}$$

$$\omega(z) = \gamma G_z z \quad \omega_1(t) = \gamma B_1(t)$$

Small Tip Approximation

$$\frac{d\vec{M}}{dt} = \begin{pmatrix} 0 & \omega(z) & 0 \\ -\omega(z) & 0 & \omega_1(t) \\ 0 & -\omega_1(t) & 0 \end{pmatrix} \vec{M}$$

$M_z \approx M_0$ small tip-angle approximation

$$\sin \theta \approx \theta$$

$$\cos \theta \approx 1$$

$$M_z \approx M_0 \rightarrow \text{constant}$$

$$\left. \begin{array}{l} \sin \theta \approx \theta \\ \cos \theta \approx 1 \\ M_z \approx M_0 \rightarrow \text{constant} \end{array} \right\} \frac{dM_z}{dt} = 0$$

$$\frac{dM_{xy}}{dt} = -i\gamma G_z z M_{xy} + i\gamma B_1(t) M_0$$

$$M_{xy} = M_x + iM_y$$

First order linear differential equation. Easily solved.

$$\frac{dM_{xy}}{dt} = -i\gamma G_z z M_{xy} + i\gamma B_1(t) M_0$$

Solving a first order linear differential equation:

$$M_{xy}(t, z) = i\gamma M_0 \int_0^t B_1(s) e^{-i\gamma G_z z \cdot (t-s)} ds$$

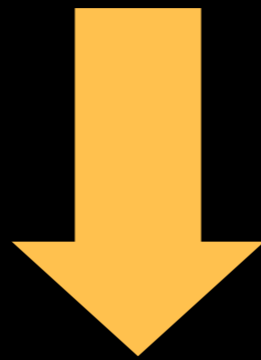

$$M_r(\tau, z) = iM_0 e^{-i\omega(z)\tau/2} \cdot \mathcal{FT}_{1D}\left\{\omega_1\left(t + \frac{\tau}{2}\right)\right\} \Big|_{f = -(\gamma/2\pi)G_z z}$$

(See the note for complete derivation)

$$M_r(\tau, z) = iM_0 e^{-i\omega(z)\tau/2} \cdot \mathcal{FT}_{1D}\left\{\omega_1\left(t + \frac{\tau}{2}\right)\right\} \Big|_{f = -(\gamma/2\pi)G_z z}$$

Small Tip Approximation

$$M_r(\tau, z) = iM_0 e^{-i\omega(z)\tau/2} \cdot \mathcal{FT}_{1D}\left\{\omega_1\left(t + \frac{\tau}{2}\right)\right\} \Big|_{f = -(\gamma/2\pi)G_z z}$$

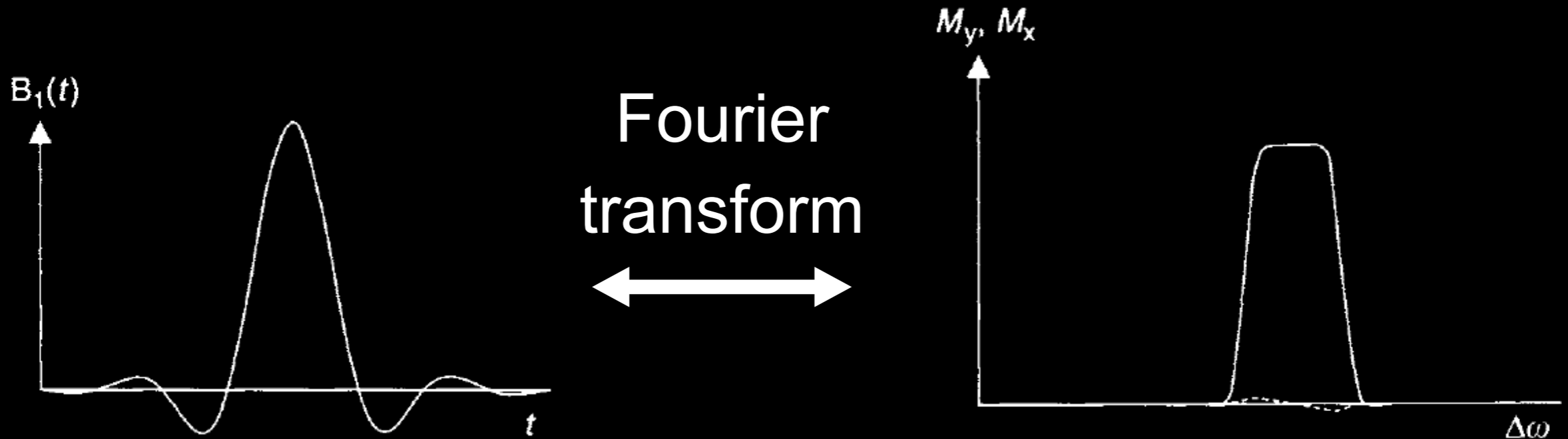

- For small tip angles, “the slice or frequency profile is well approximated by the Fourier transform of $B_1(t)$ ”
- The approximation works surprisingly well even for flip angles up to 90°

Small Tip Approximation

the excitation profile, within the small angle approximation, is just the Fourier transform of the pulse

remember that the Bloch equations are non-linear and thus cannot be expected to behave linearly

the approximation works surprisingly well even for flip angles up to 90°

Shaped Pulses

30°

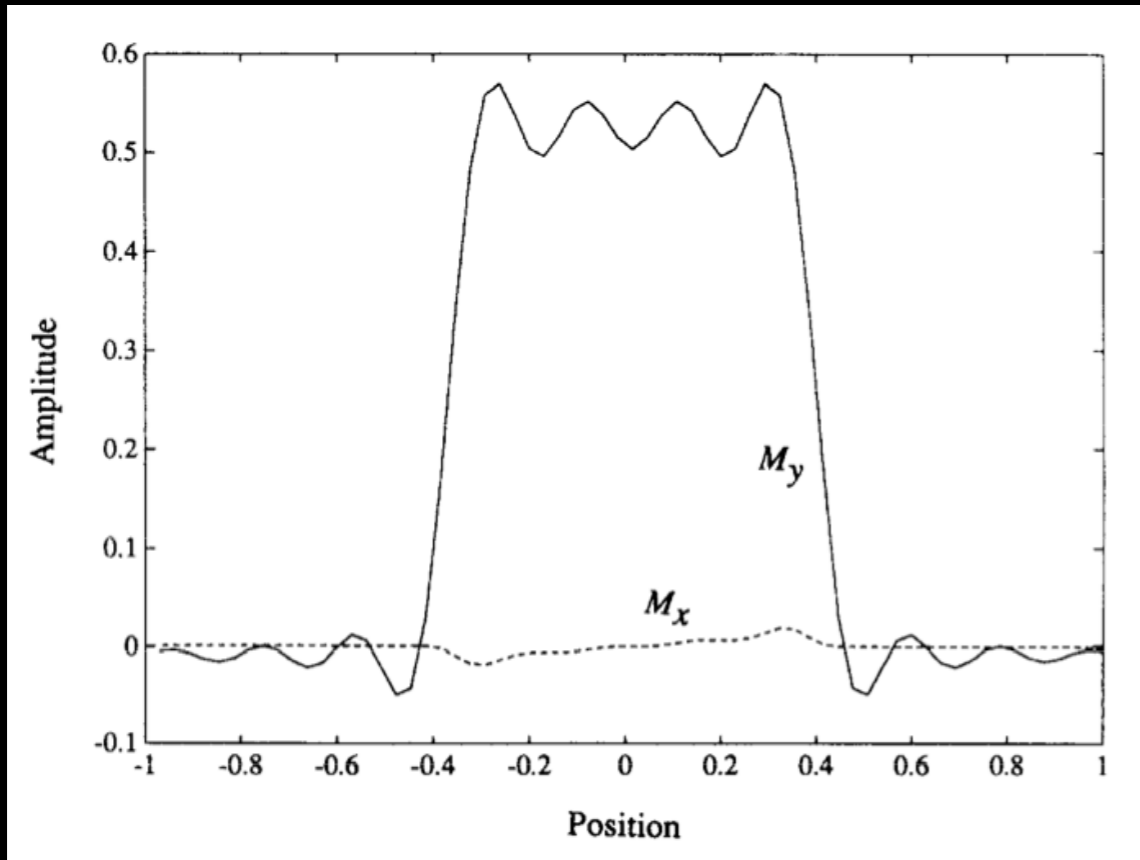

90°

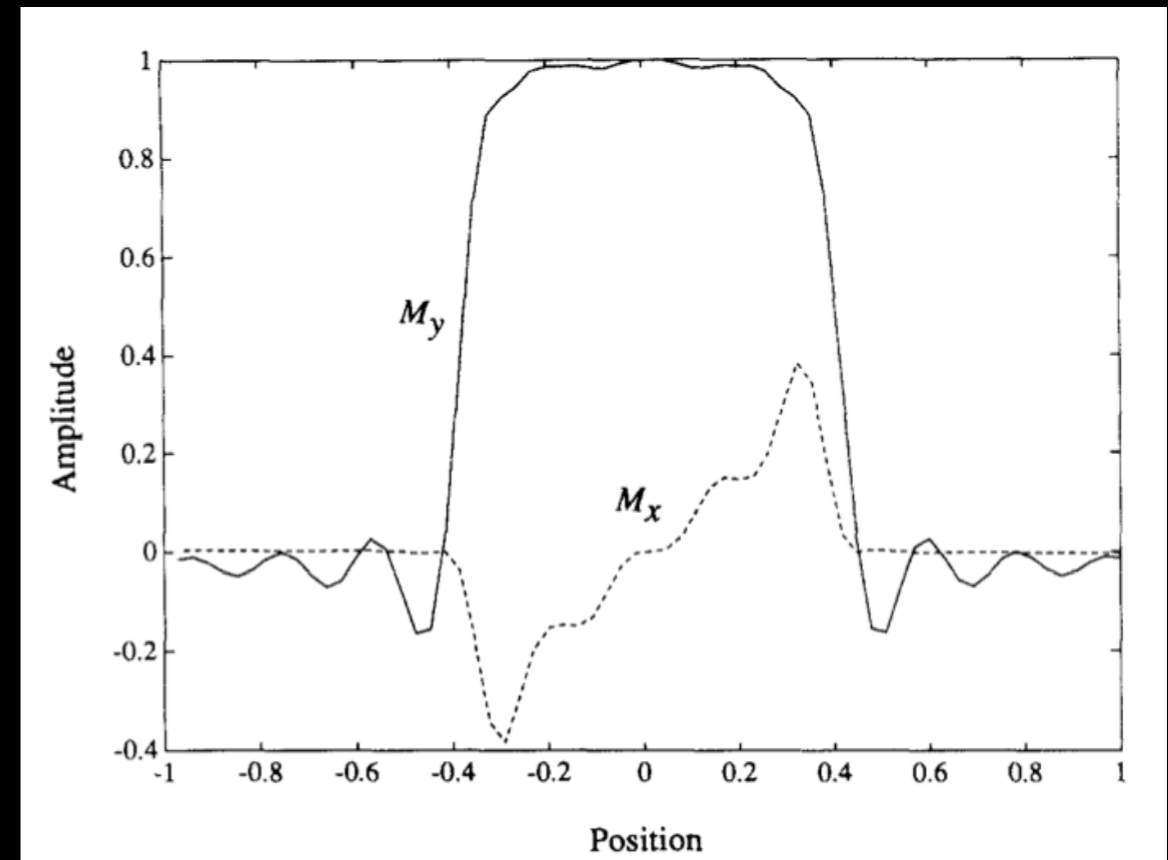

Pauly, J. J. *Magn. Reson.* **81** 43-56 (1989)

small-angle approximation still works reasonably well for flip angles that aren't necessarily "small"

Truncation Artifacts

in MRI we want pulses to be as short as possible
to avoid relaxation effects

the sinc function is defined over all time
which is impractical in any experiment

the sinc pulse needs to be truncated to be
appropriate for clinical scans

Truncation Artifacts

what happens when we truncate our pulses?

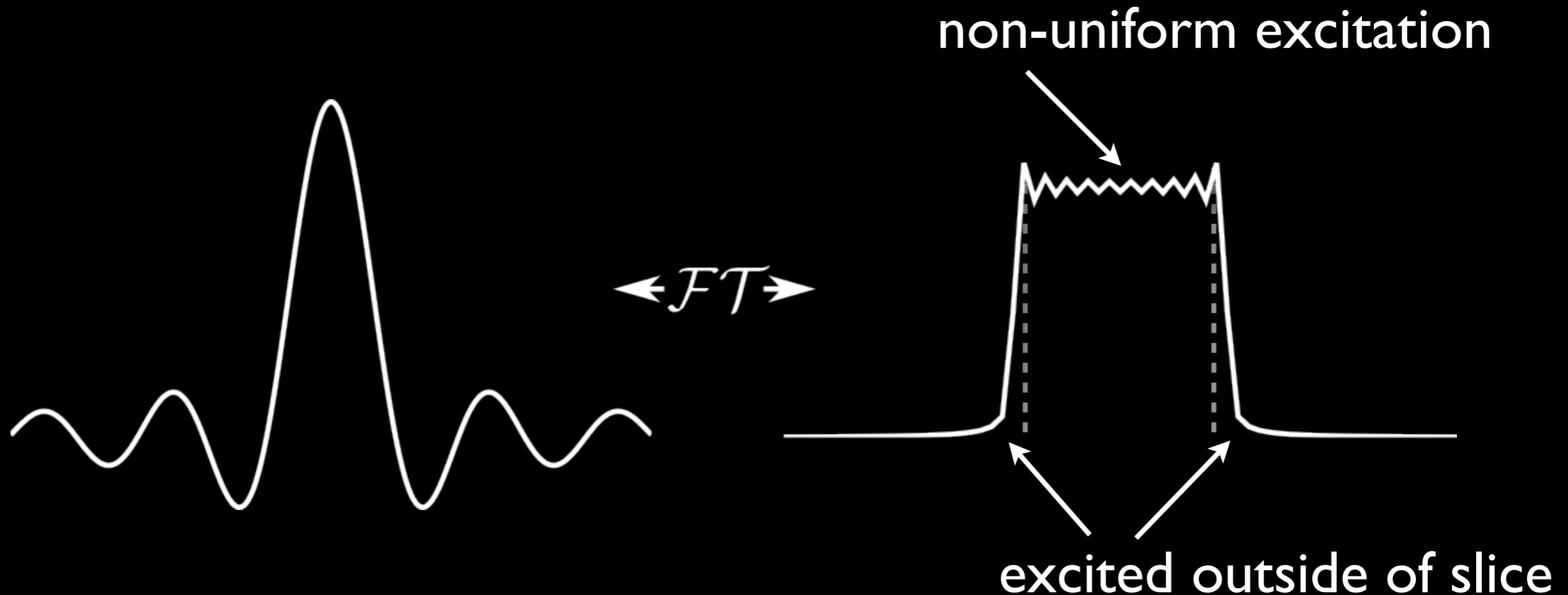

these deviations from the ideal are known
as truncation artifacts

Truncation Artifacts

alternative Pulse Shapes

gaussian

$$B_x(t) = A \exp \left[-a(t - \tau/2)^2 \right]$$

reduced side-lobes, but not as flat of a profile

Window Functions

Hamming, Hanning, ...

Slice Rewinder

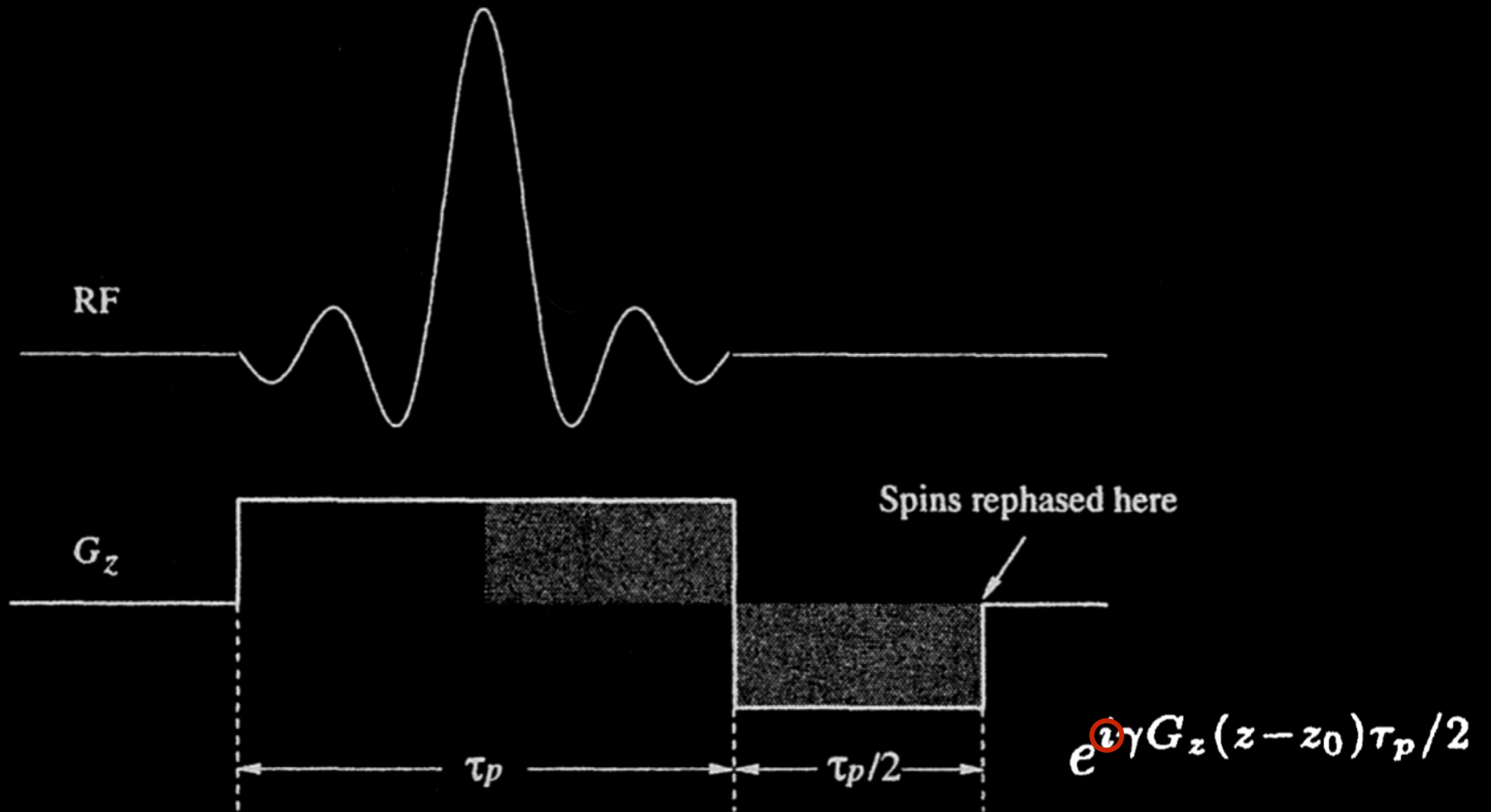

Opposite Polarity

Slice Selective Excitation Example

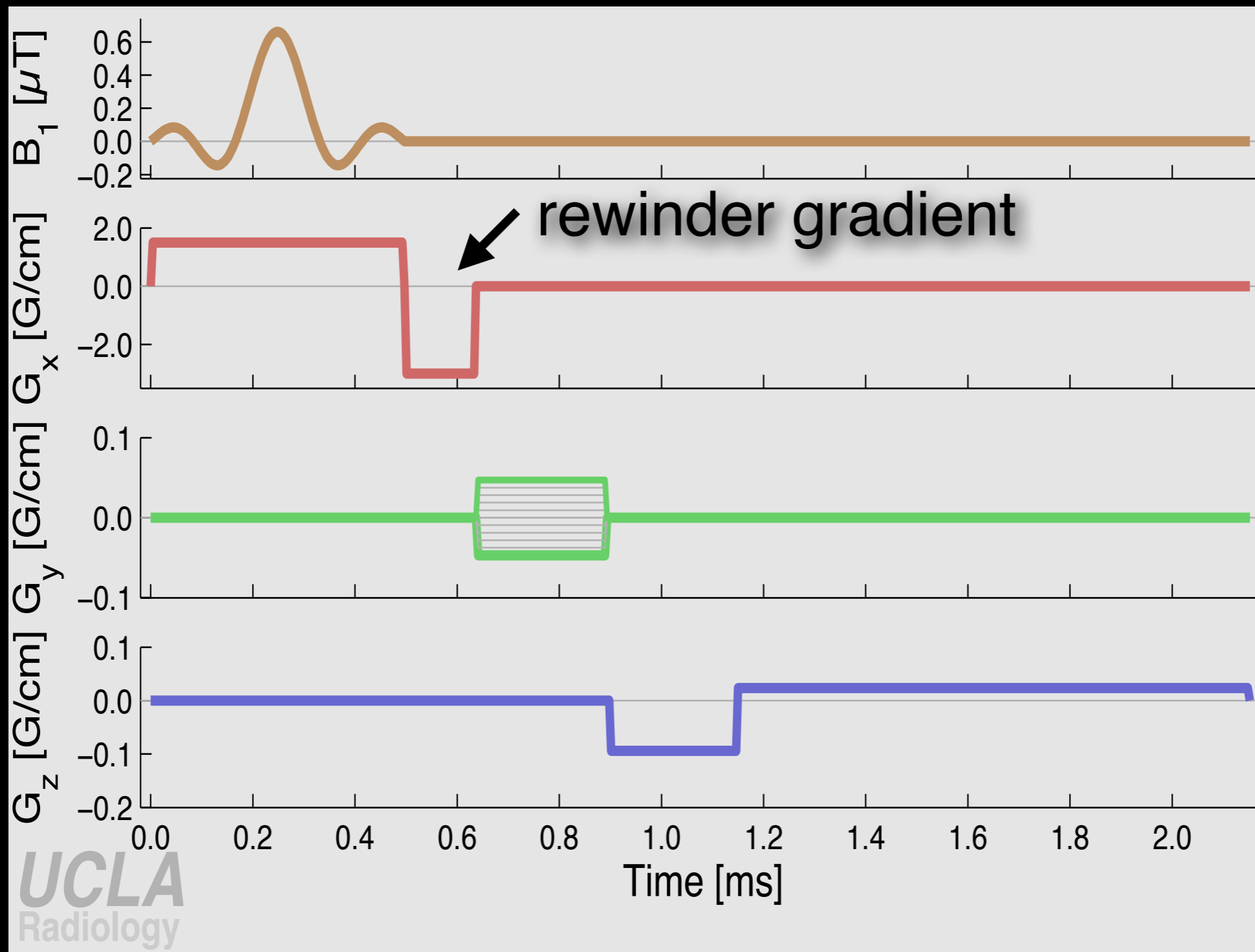

slice select gradient rewinder eliminates the linear phase ramp

Selective Excitation: Conclusion

B1 amplitude

-> flip angle

B1 amplitude profile

-> bandwidth, slice profile

B1 carrier frequency

-> slice location

B1 phase profile

-> slice location, etc.

Small Tip Approximation

-> slice profile = FT of B1 envelope function

Questions?

- Related reading materials
 - Liang/Lauterbur - Chap 5.1
 - Nishimura - Chap 6.1, 6.2, 6.4

Kyung Sung, Ph.D.

KSung@mednet.ucla.edu

<http://mrri.ucla.edu/sunglab>